



Household Keys  
Chiavi Piatte  
Flachschlüssel  
Clés plates  
Llaves Planas  
Chaves Planas



PER:  
FOR:

3F

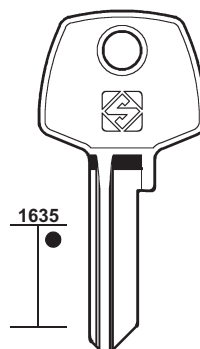
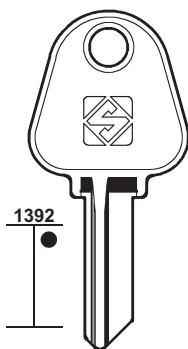
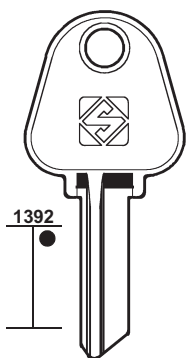
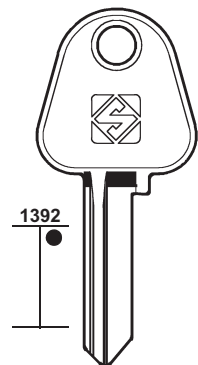

3

PER / FOR

3F (BR)

3M (PRC)

333 (IL)  
+ CORNI (55)

555 (RC)  
CINA (48)

606 (RA)

PER:  
FOR:

3F

3M

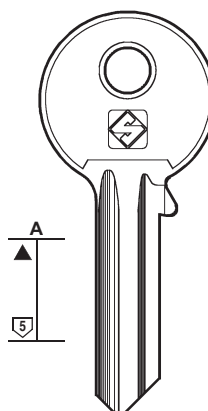
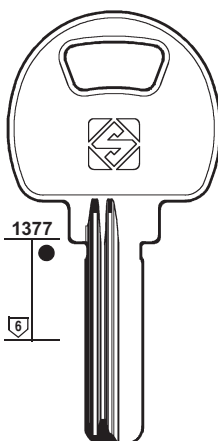
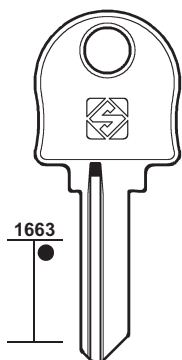
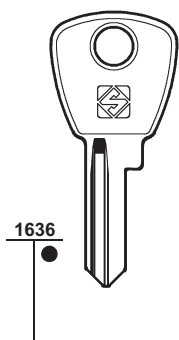

PER:  
FOR:

333

606

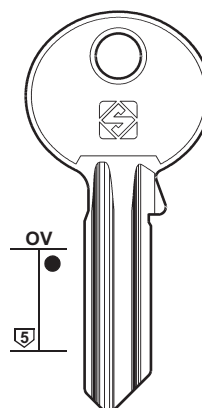
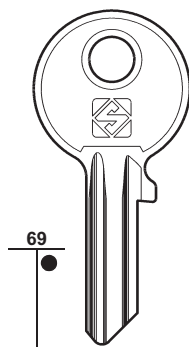
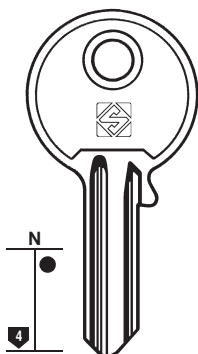
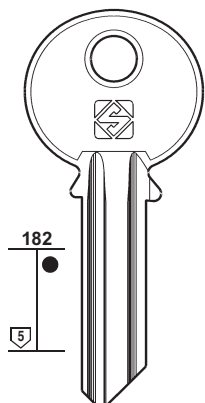



4

PER / FOR

aaa (IL)

ABA (GR)

ABBES (GB)  
LAS (111)

ABC (E)  
BAGEM

ABLOY (FIN)  
KITTY  
VIRO

PER:  
FOR: aaa

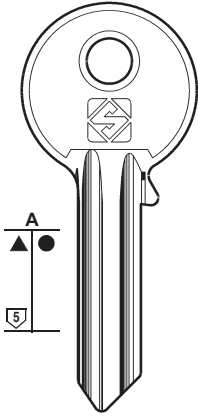

AAA1

ABA

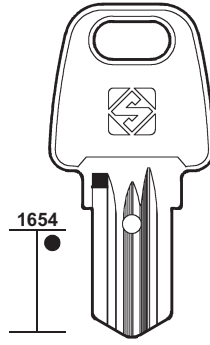

AAB1

ABC

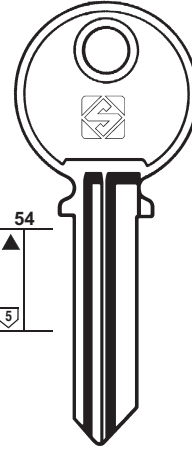

AC1

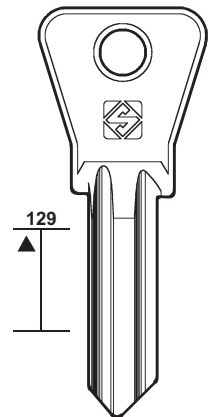

AC2

BAGEM

PER:  
FOR:

ABLOY

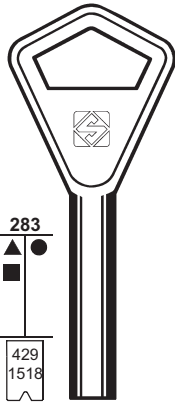

AY1

..... (DX)  
..... (SX)  
0-1-2-3-4-5-6-7-8-9

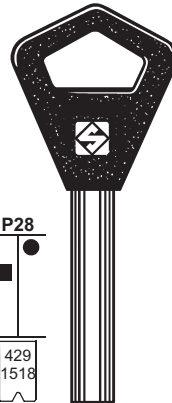

AY1P

..... (DX)  
..... (SX)  
0-1-2-3-4-5-6-7-8-9



KITTY - VIRO

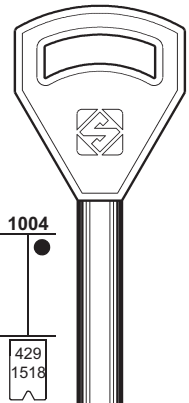

AY11

PER:  
FOR:

ABLOY

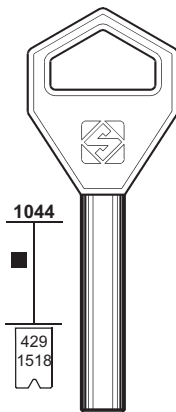

AY12

..... (DX)  
..... (SX)  
0-1-2-3-4-5-6-7-8-9

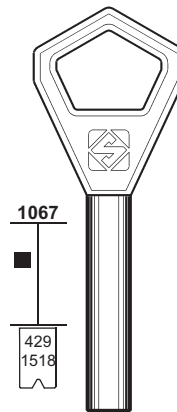

AY16

..... (DX)  
..... (SX)  
0-1-2-3-4-5-6-7-8-9

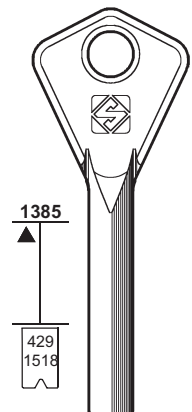

AY30



PER:  
FOR:

# ABLOY

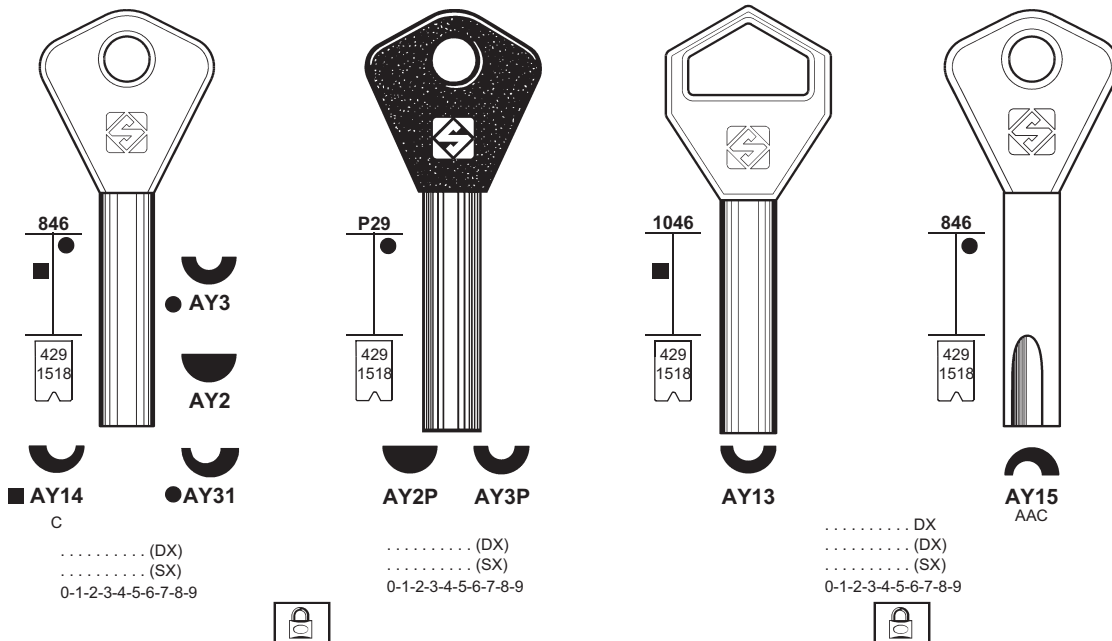

# 5

PER / FOR

ABLOY (FIN)

PER:  
FOR:

# ABLOY

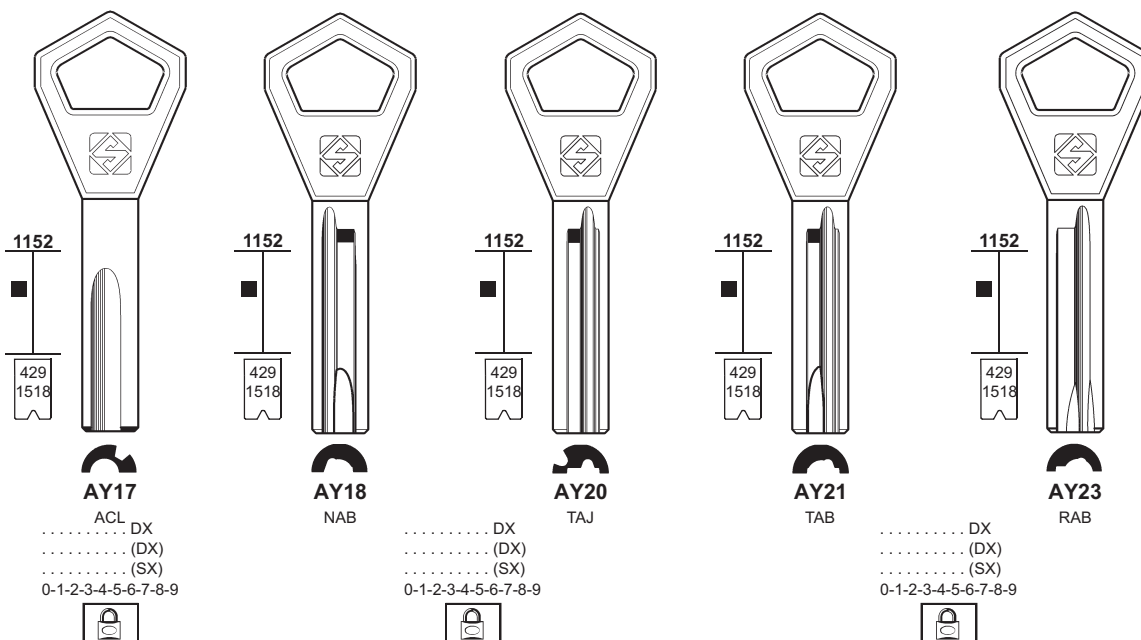

PER:  
FOR:

# ABLOY

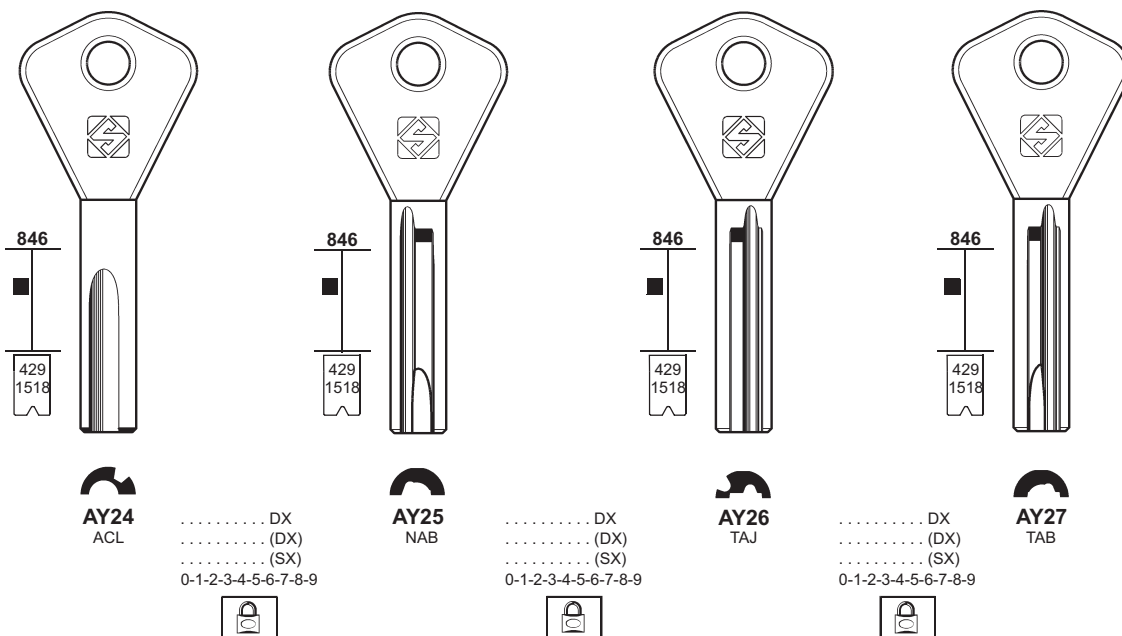



6

PER / FOR

ABLOY (FIN)

ABT (I)

+ VIRO (187)

ABUS (D)

CISA

JPM

OTHMER

TOP

+ G.R. (90)

+ GUARD (90-91)

+ PFAFFENHAIN (141)

+ YALE (194)

PER:  
FOR:

### ABLOY

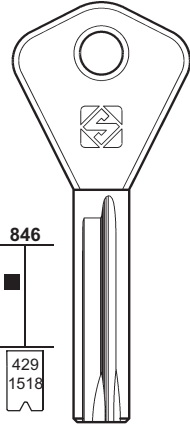

846  
429  
1518



AY28  
RAB

..... DX  
..... (DX)  
..... (SX)  
0-1-2-3-4-5-6-7-8-9

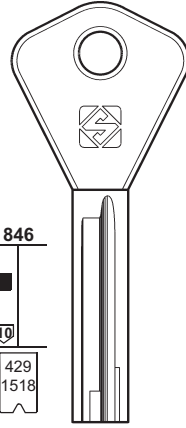

846  
429  
1518



AY29  
RAG

..... (DX)  
..... (SX)  
0-1-2-3-4-5-6-7-8-9

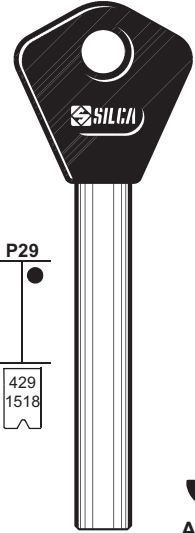

P29  
429  
1518



AY10P



PER:  
FOR:

### ABUS

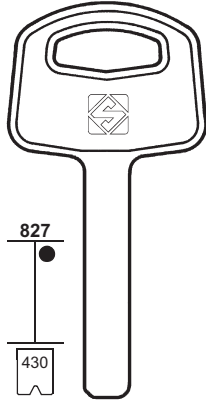

827  
430

AB32  
.....  
1-2-3-4-5-6

GRANIT

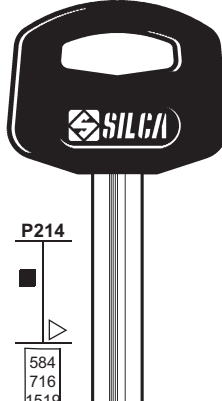

P214  
584  
716  
1519

AB38P  
.....  
1-2-3-4-5-6

ABUS PLUS

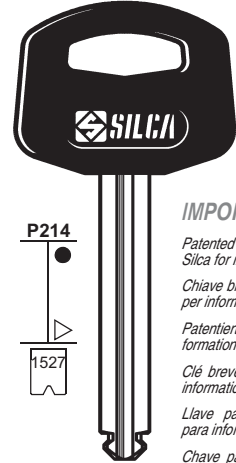

P214  
1527

AB60P  
.....  
1-2-3-4-5-6

#### IMPORTANT!

Patented key, please contact Silca for information.  
Chiave brevettata, rivolgersi a Silca per informazioni.  
Patentierter Schlüssel. Bitte, für Informationen an Silca sich wenden.  
Clé brevetée, contacter Silca pour information.  
Llave patentada, contactar Silca para informaciones.  
Chave patenteada, por favor contacte Silca para informação.

PER:  
FOR:

### ABUS

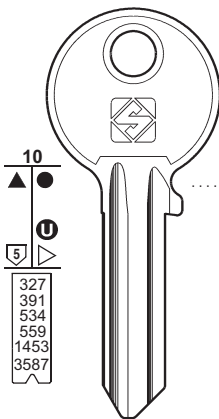

10  
327  
391  
534  
559  
1453  
3587

AB1R  
.....  
1-2-3-4-5-6

AB1  
.....  
1-2-3-4-5-6

BJ ..... 1-20728  
..... 1-2-3-4-5-6-7-8-9  
C42 ..... 1-2-3-4-5-6-7-8-9  
P ..... 00000-02360

AY ..... 1-6032  
BA ..... 1-6032  
BB ..... 1-6032  
BC ..... 1-6032  
BD ..... 1-6032  
BK ..... 1-6032  
BL ..... 1-6032  
BM ..... 1-6032  
BN ..... 1-6032  
BP ..... 1-6032  
BQ ..... 1-6032  
BR ..... 1-6032  
BS ..... 1-6032  
BT ..... 1-6032  
BU ..... 1-6032  
BY ..... 1-6032  
SA ..... 1-6032  
SB ..... 1-6032

AB10R  
F3  
BCISS ..... 1-6032  
F2D ..... 1-6032

AB10  
F3  
..... AA 000-999  
..... AB 000-999  
..... AF 001-954  
..... AM 001-988  
..... AN 001-958  
..... AV 001-999  
..... BB 001-636  
..... BK 001-997  
..... BL 001-998  
..... BM 002-999  
..... BP 001-331  
..... BQ 001-398  
..... BR 001-397  
..... BT 000-999  
..... BU 000-999  
..... BV 000-999  
..... GF 001-892  
..... GG 001-879  
..... GH 001-359  
..... GJ 001-358  
..... GK 001-308  
..... GM 001-999  
BCISS ..... 1-6032  
F2C ..... 1-6032

AB8

AB21  
X4D

AB22

AB78R

AB26  
OTHMER  
B09

AB8R

AB21R  
X4S

AB25R

AB47R

AB34  
B49

AB36

AB37

AB44

AB42R

AB75

AB36R

AB37R

AB44R

AB42R

AB67

JM1  
F3

AY-BA  
BB-BC  
BD-DK  
BL-BM  
BN-BP  
BQ-BR  
BS-BT  
BU-BY  
SA-SB  
F3C  
..... 1-6032

TOP1R  
TOP

JM1R  
F3  
F3D ..... 1-6032

JM2

JM2R

CISA - JPM - OTHMER - TOP

PER:  
FOR:

# ABUS

Key 1: Dimensions OV, 5. Bit patterns: AB79RX, AB70X, AB69X, AB68X, AB1X, AB1RX, AB55X. Brand: BRICARD.  
 Key 2: Dimension 1329, 5. Bit patterns: AB86, AB61, AB83, AB72 K1S, AB72R K1D.  
 Key 3: Dimension OV, 5. Bit patterns: AB4 003, AB5 001, AB6 004. Brand: GEGE.  
 Key 4: Dimension 54, 5. Bit pattern: AB7.



# 7

PER / FOR

- ABUS (D)**  
 ANCHOR  
 BRICARD  
 BUFFO  
 CISA  
 GEGE  
 JET  
 JPM  
 KALE  
 + G.R. (90)  
 + GUARD (90-91)  
 + PFAFFENHAIN (141)  
 + YALE (194)

PER:  
FOR:

# ABUS

Key 1: Dimensions A, 759, 5. Bit patterns: AB14, AB14R. Code: ..... 1-2-3-4-5. Brand: ANCHOR - JET - JPM - KALE.  
 Key 2: Dimensions 255, 6. Bit pattern: AB9. Brand: ANCHOR - JET - JPM - KALE.  
 Key 3: Dimensions 595, 714, 5. Bit pattern: AB19. Code: ..... 1-2-3-4-5-6. Brand: ANCHOR - JET - JPM - KALE.  
 Key 4: Dimensions 11, 326, 568, 3588, 5. Bit patterns: AB3, AB3R. Code: ..... 1-2-3-4-5-6. A: ..... 1-01321. Brand: CISA.

PER:  
FOR:

# ABUS

Key 1: Dimensions 11, 326, 500, 4. Bit patterns: AB2, AB2R. Code: ... 1-342. EE: ... 1-800. ..... 1-2-3-4-5-6. B: ... 1-342. E: ... 801-1236. EF: ... 1-724. ER: ... 801-1236. Brand: BUFFO - CISA.  
 Key 2: Dimensions 11, 4. Bit pattern: AB18. Brand: BUFFO - CISA.  
 Key 3: Dimensions 167, 4. Bit patterns: AB11, AB11R. Brand: BUFFO - CISA.  
 Key 4: Dimensions 2, 5. Bit pattern: AB20. Brand: BUFFO - CISA.



8

PER / FOR

ABUS (D)

- ANCHOR
- ARMSTRONG
- BASI
- BURG
- CISA
- FTH
- GUARD
- GUITTEL
- IMP
- MASTER
- ROYAL

- + G.R. (90)
- + GUARD (90-91)
- + PFAFFENHAIN (141)
- + YALE (194)

PER:  
FOR:

ABUS

AB17 AB17R  
... 1-2000  
... 1-2-3-4-5

AB13 AB13R ▲  
... 1-2-3-4-5  
FTH

AB24 ▲

AB29R

AB12 AB12R  
... 1-2-3-4-5

AB16 AB16R  
... 1-200  
... 1-2-3-4-5

AB15 AB15R  
... 1-60  
... 1-60  
... 1-2-3-4-5 1-2-3-4-5

AB23  
... 1-24  
... 65/25 1-2-3-4-5

AB23R

ANCHOR - IMP

ANCHOR - BURG  
GUITTEL - IMP - ROYAL

CISA

BASI - GUARD

PER:  
FOR:

ABUS

AB81

AB27  
... 1-2-3-4-5-6  
mm 50-60

AB30 AB30R

AB31

PER:  
FOR:

ABUS

AB35 AB35R

AB39 AB39R

AB41R

AB43 AB43R

AB45

MASTER

ARMSTRONG



PER:  
FOR:

# ABUS

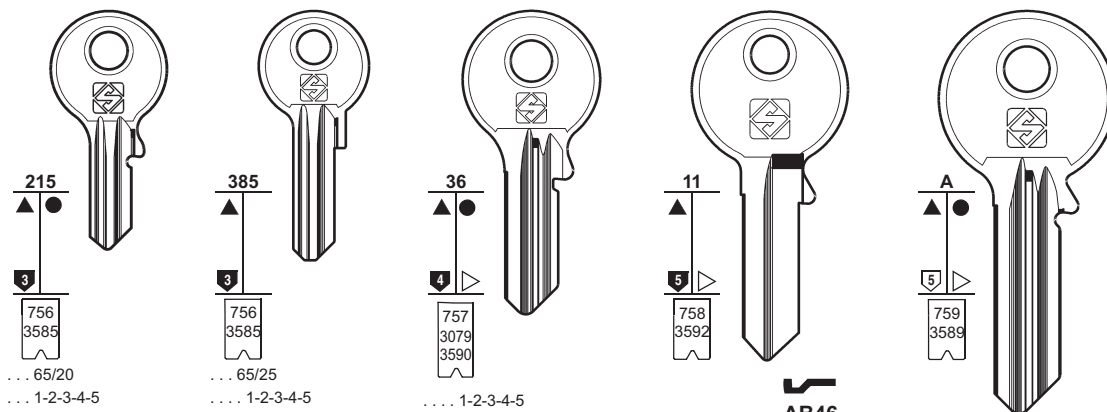

**AB50**

**AB51**

**AB53**

**AB52**  
..... 1-2-3-4-5  
..... 1-2-3-4-5-6

**AB71**

**AB54**  
..... 1-2-3-4-5



# 9

PER / FOR

- ABUS (D)**  
**BUFFO**  
**FORT**  
**SECURITAL**  
 + G.R. (90)  
 + GUARD (90-91)  
 + PFAFFENHAIN (141)  
 + YALE (194)

PER:  
FOR:

# ABUS

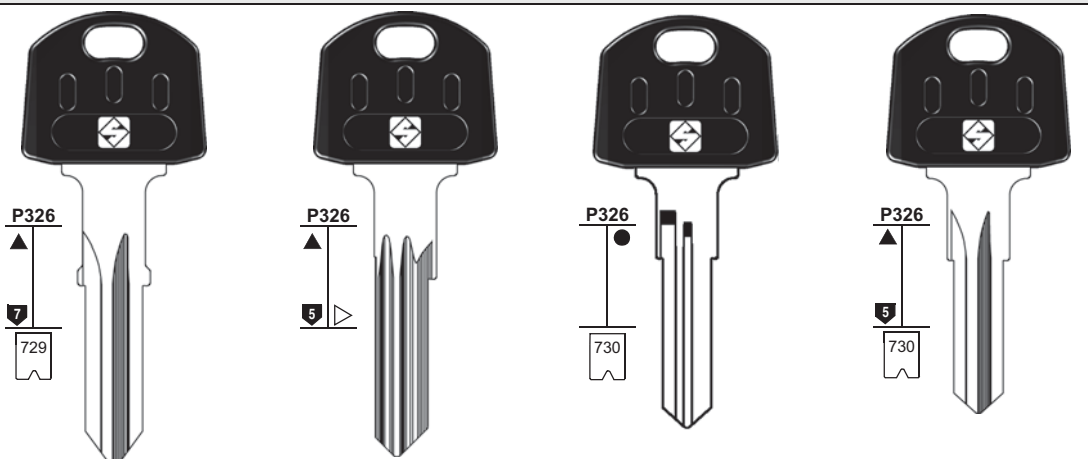

**AB57AP**   **AB57RAP**  
Z71 ... 1-1043   Z71 ... 1-1043  
Z72 ... 1-1043   Z72 ... 1-1043

**AB56AP**  
SL ...  
1-2515

U72   **AB64RAP**  
F82   V62 ... 1-331  
X61 ... 1-331  
X62 ... 1-331

**AB65RAP** W71

**AB58RAP**   **AB59RAP**  
X61 ... 1-331   V61 ... 1-331  
X62 ... 1-331  
V62 ... 1-331



BUFFO



PER:  
FOR:

# ABUS

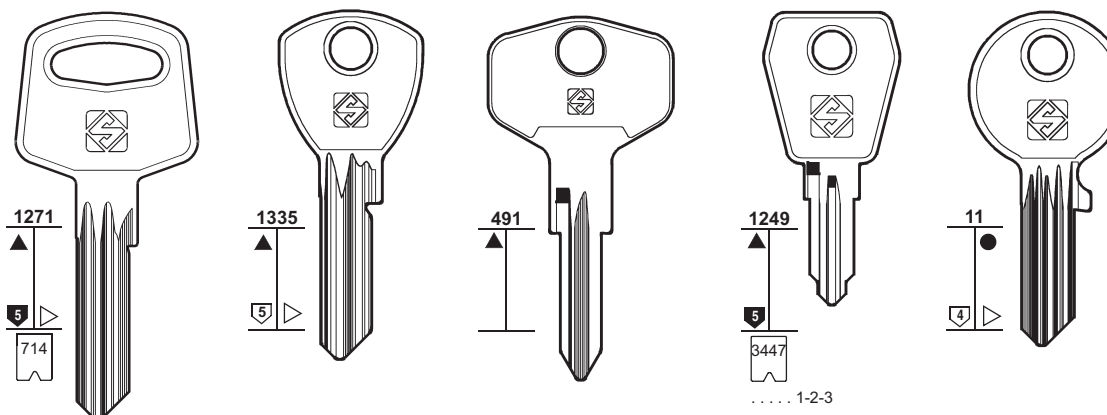

**AB56**   **AB56R**  
SR ...   SL ...  
1-2515   1-2515

**AB76**   **AB76R**

**AB93R**

**AB90R**  
FG

**AB85**  
AL



FORT - SECURITAL



# 10

### PER / FOR

**ABUS (D)**  
 CISA  
 BRICARD  
 + G.R. (90)  
 + GUARD (90-91)  
 + PFAFFENHAIN (141)  
 + YALE (194)

**ACE (USA)**  
 CHICAGO (46)

**ADAMS RITE (USA)**

**ADEMCO (USA)**  
 CHICAGO (46)

**ADS (D)**

**AEP (LV)**

**AGA (E)**  
 ARREGUI  
 BTV  
 MECALUX  
 SUYOKA  
 + CHICAGO (46)

PER:  
 FOR:

## ABUS

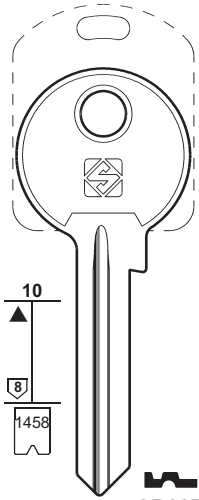

**AB66R**  
48/49

..... 1205-9533  
 ..... 1717-9020

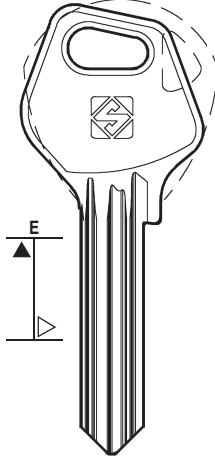

**AB91**

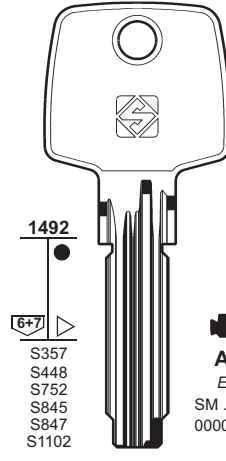

**AB74**

..... 00001-38832  
 ..... 0001-4800  
 ..... (XN005710)1-38832  
 ..... 000001-168000

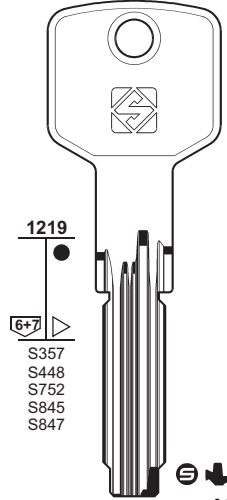

**AB84**  
EC550

**AB77**

**AB48**  
D6

..... 00001-38832  
 ..... 0001-4800  
 ..... (XN005710)1-38832  
 ..... 000001-168000



NEW ASTRAL

PER:  
 FOR:

## ABUS

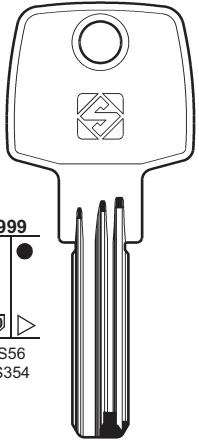

999  
 S56  
 S354

**AB40**  
AAL  
EXTRA-CLASSE



CISA - BRICARD

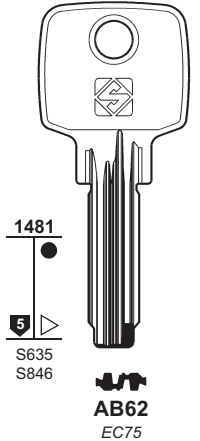

1481  
 S635  
 S846

**AB62**  
EC75

..... 00001-10000  
 D8 ..... 0001-8000



mm 30-40-50



## ADAMS RITE

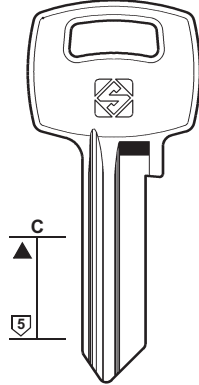

C  
 S

**ADT1**



## ADS

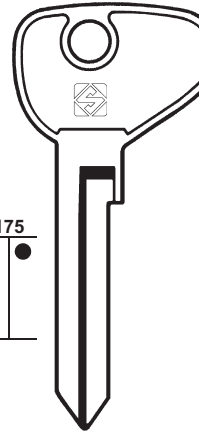

175

**AD1**

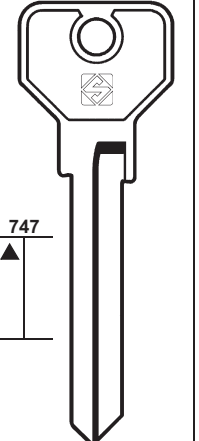

747

**AD2**



PER:  
 FOR:

## AEP

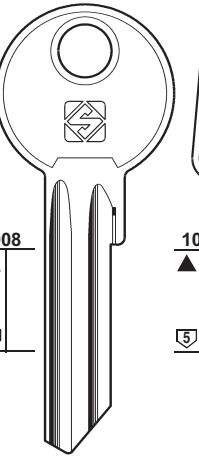

908  
 S

**AEP1**

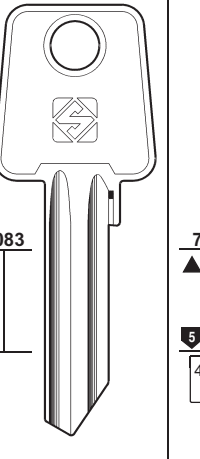

1083  
 S

**AEP2**

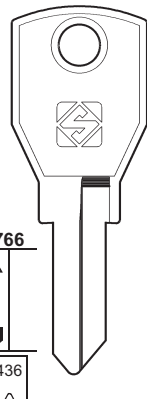

766  
 S  
 436

**AGA1**  
B...  
901-926

**AGA2**  
D...  
901-926

**AGA4**  
G... 501-526  
G... 901-926

**AGA5**  
E... 501-526  
E... 901-926



BTV - MECALUX  
SUYOKA

## AGA

**AGA1R**  
A...  
901-926

**AGA2R**  
C...  
901-926

**AGA4R**  
H... 501-526  
H... 901-926

**AGA5R**  
F... 501-526  
F... 901-926

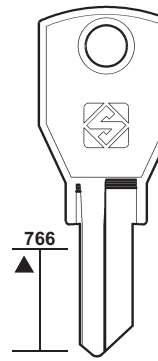

766

**AGA3**

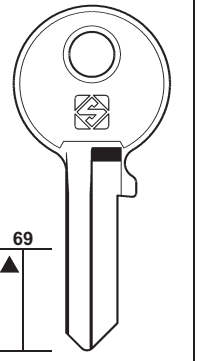

69

**AGA25**

**AGA25R**



PER:  
FOR:

## AGA

54  
477  
1197  
1197

S177  
S842  
S897  
S898  
S971  
S972  
S971  
S1020

S841  
S895  
S896

AGA6      AGA8      AGA7      AGA9

GARI      COLOMENCA - FB      CASAS

SERRALLER - TERCA

## AGB

599

U C

583

AGB1      AGB1R

SAVIO

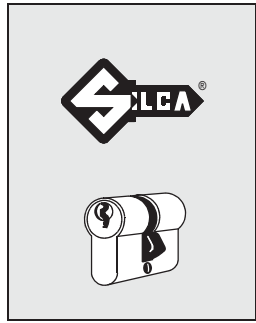

# 11

PER / FOR

**AGA (E)**  
CASAS  
COLOMENCA  
FB  
GARI  
SERRALLER  
TERCA  
+ CHICAGO (46)

PER:  
FOR:

## AGB

599      600      600      1275

U C      U C      U C      U C

4      5      4      4

S171  
S534

..... 0/9  
..... A/Z

AGB2      AGB2R      AGB3      AGB3R      AGB4      AGB5

SAVIO      SAVIO      SCUDO 9000

**AGB (I)**  
SAVIO

PER:  
FOR:

## AGB

1434      1434      1434      1434

C      C      C      C

7      6      7      6

S633      S647  
S1330  
S1409  
S1440      S633      S647  
S1330  
S1409  
S1440

..... 0/9  
..... A/Z

AGB8      AGB9      AGB6      AGB7

SCUDO 7000      SCUDO 5000

SCUDO



12

PER / FOR

AGE (J)

AGENT (J)

AGUIA (P)

AISPUTE (LV)  
KURZEMES

AKIRA (I)

YETI (198-199)

AKKA (I)

WALLY (188)

PER:  
FOR:

### AGE

### AGENT

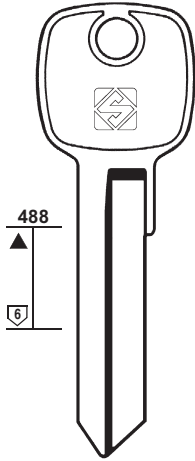

AGE5R

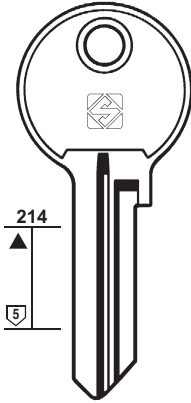

AGE2

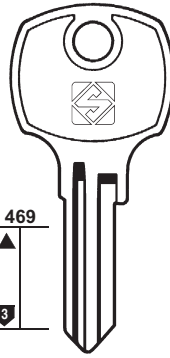

AGE3

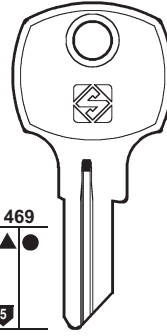

AGE1 AGE1R

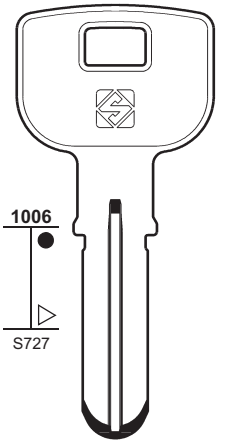

AGN1



PER:  
FOR:

### AGUIA

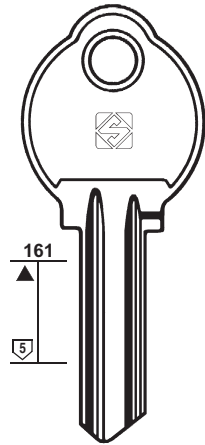

AG1 AG1R

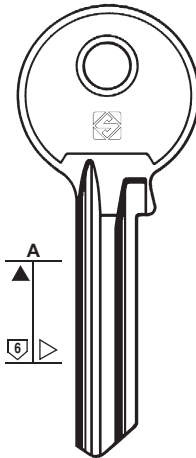

AG4 AG4R

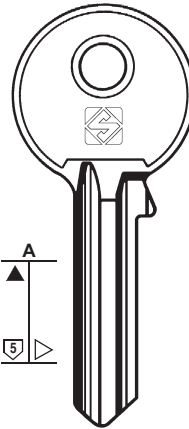

AG2 AG2R

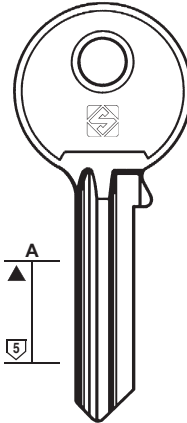

AG3 AG3R

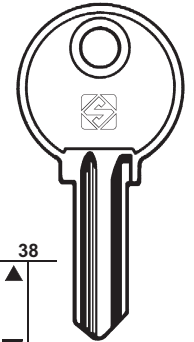

AG5 AG5R

AG7

AG7R

AG6

AG6R

PER:  
FOR:

### AGUIA

### AISPUTE

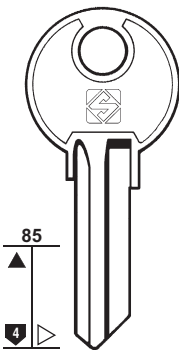

AG8 AG8R

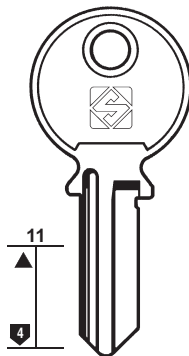

AG9 AG9R

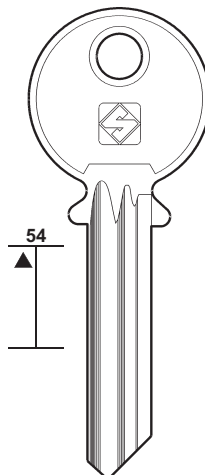

AG10

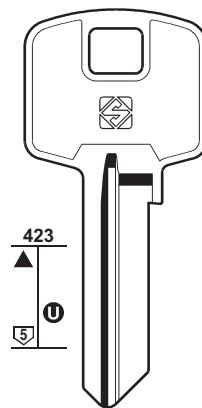

ASU1R

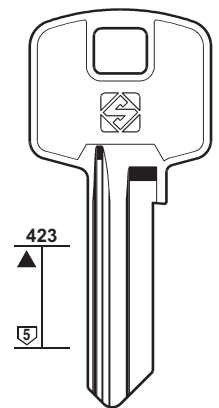

ASU2

KURZEMES

PER: FOR:	AL	AL AHRAM	ALA	
	 ● AL1 ▲ AL1R	 AHR2	 AA6 ● AA6R	 AA5 ● AA5R
			 mm 70	 mm 60

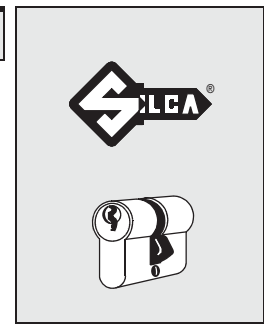

**13**

PER / FOR  
**AL (P)**  
**AL AHRAM (ET)**  
**ALA (I)**  
 CISA  
 + CISA (50)  
 + KESO (105)  
**ALDRIDGE E. (GB)**  
 ASEC SECURITY

PER: FOR:	ALA				
	 AA1 AA1R	 AA2 AA2R	 AA3 ... 1-2-3-4-5-6-7	 AA4 AA4R	 CS12 CS12R
	 mm 50	 mm 40	 mm 30		 CISA mm 15

PER: FOR:	ALDRIDGE E.		
	 AE1R	 AE2R	 ⊖ ASEC1
			 ASEC SECURITY



14

PER / FOR

ALDRIDGE E. (GB)  
ASEC SECURITY

ALF (F)  
CISA (48)

ALFA (S)

ALI (RC)  
CINA (48)

ALIANÇA (BR)

ALKE (I)

ALLGOOD (GB)  
CENTURY (41)

ALMET (USA)  
ARROW (18)

ALPHA (I)  
+ CHICAGO (46)

PER: ALDRIDGE E.  
FOR:

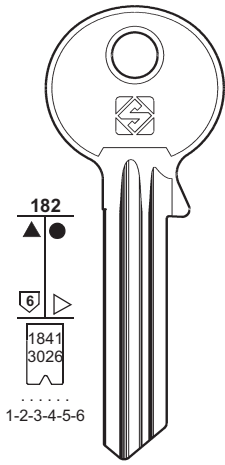

ASEC2

ASEC SECURITY

ALFA

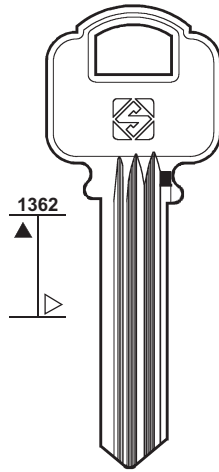

ALA1R



ALA2R

ALIANÇA

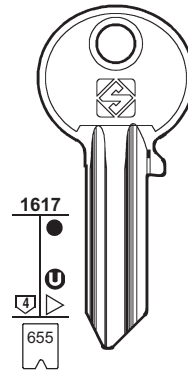

AI1

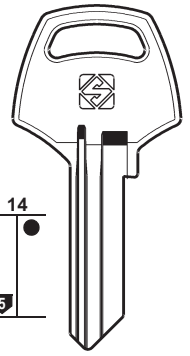

AI2

PER: ALKE  
FOR:

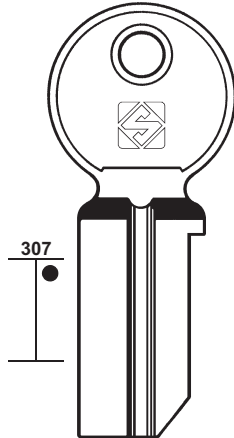

ALK1

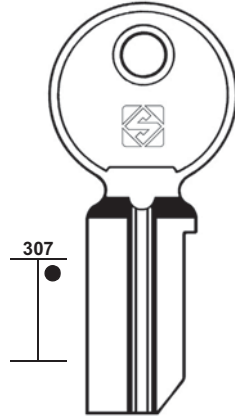

ALK2



ALPHA

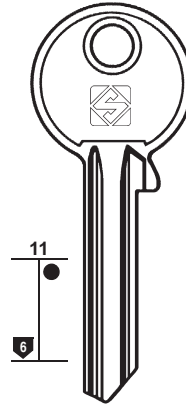

ALP2

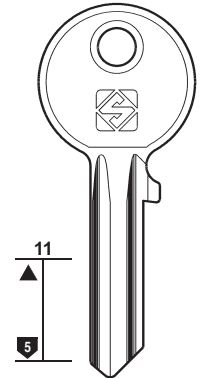

ALP11

PER: ALPHA  
FOR:

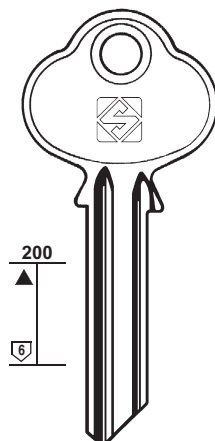

ALP3

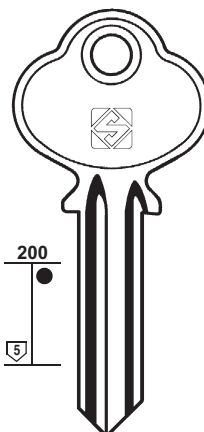

ALP10

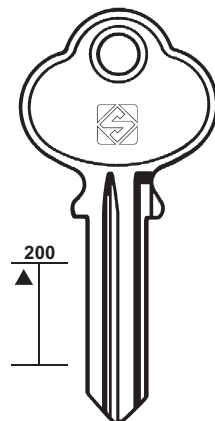

ALP1

PER:  
FOR:

# ALPHA

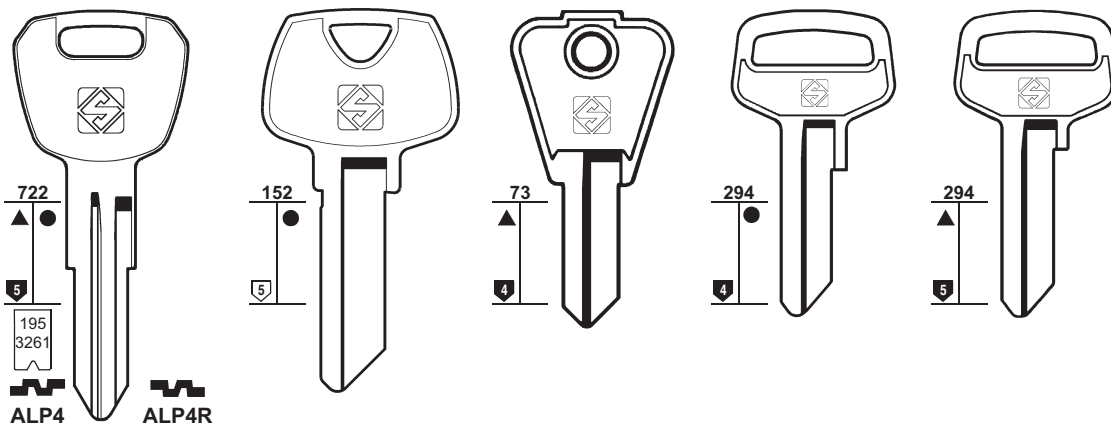

ALP4 ALP4R

S... 301-600

FEB

ALP9  
7000...

ALP9R  
LINCE  
JD

ALP6R

ALP5R

ALP8R

ALP7R



MONACOR - SANY - VISONIC



HMP



HMP



HMP



# 15

PER / FOR

**ALPHA** (I)  
FEB  
HMP  
JD  
LINCE  
MONACOR  
SANY  
VISONIC  
+ CHICAGO (46)

**ALSO** (USA)  
 JUNKUNC (101)  
 STS (162)

**ALUBOX** (I)

**ALUNORM** (I)  
 CORBIN (53)

**AM** (I)  
 POTENT (142)

**AMARO LIMITADA** (P)  
PICARDIE

**AMELCO** (BR)

**AMERICAN** (USA)  
 JUNKUNC (101)

**AMEROCK** (USA)  
 ARROW (18)

PER:  
FOR:

# ALPHA

# ALUBOX

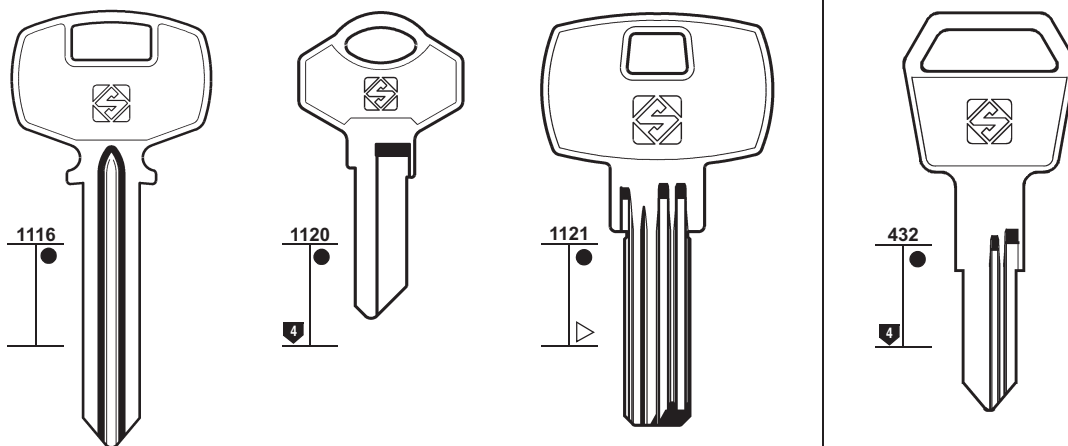

ALP12

ALP14R

ALP16

ALU1



HMP



HMP

PER:  
FOR:

# AMARO LIMITADA

# AMELCO

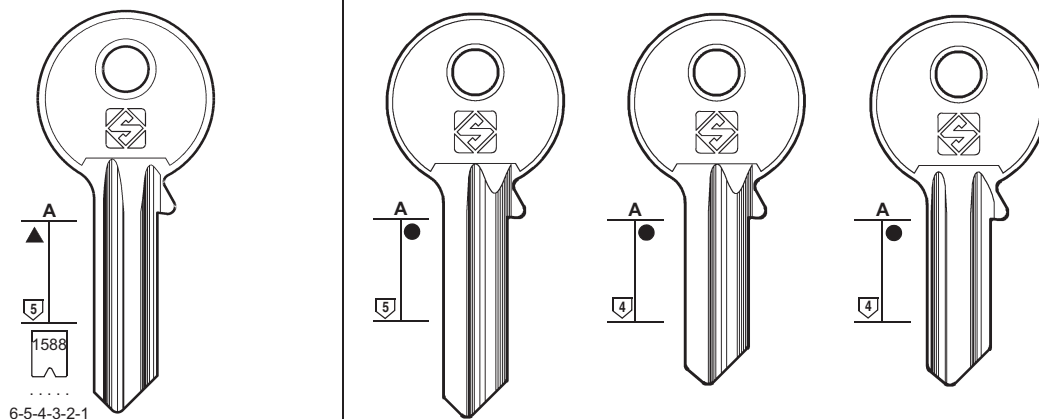

ALM1

ALM1R

AMC2R

AMC1R

AMC3

PICARDIE



# 16

PER / FOR

**AMIG (E)**

**ANCHOR (S)**  
ANKERSLOT  
+ ABUS (7-8)

**ANHSIN (HK)**

**ANKERSLOT (NL)**  
ANCHOR  
LITTO  
ODA  
+ ANCHOR (16)  
+ LITTO (113)

PER:  
FOR: **AMIG**

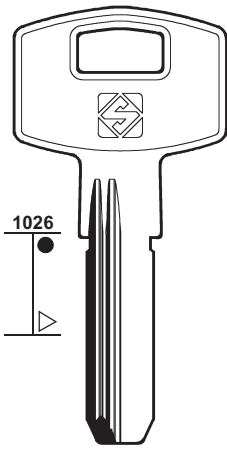

**AMG1R**



**ANCHOR**

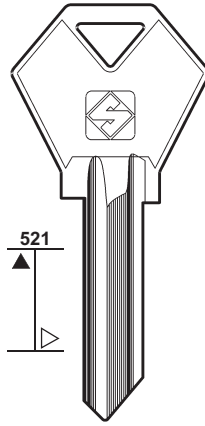

**ACR1**

ANKERSLOT

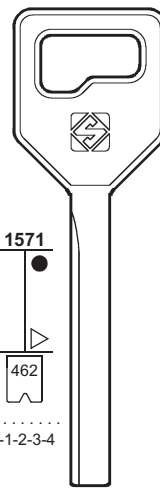

**ACR3**

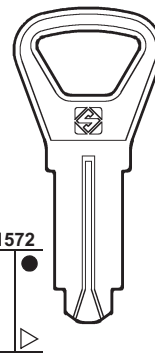

**ACR4**



**ANHSIN**

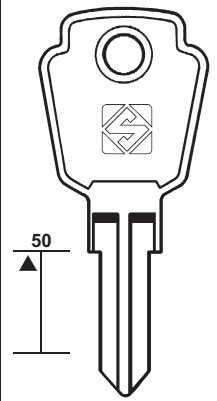

**AH1**

PER:  
FOR:

## ANKERSLOT

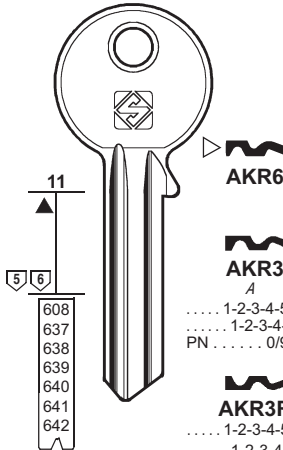

**AKR6**

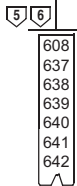

**AKR3 A**

..... 1-2-3-4-5-6-7  
..... 1-2-3-4-5-6-7  
PN ..... 0/9 1-2-3-4-5-6-7

**AKR3R**

..... 1-2-3-4-5-6-7  
..... 1-2-3-4-5-6-7  
... L ... 1234567RSTUVWX



ODA

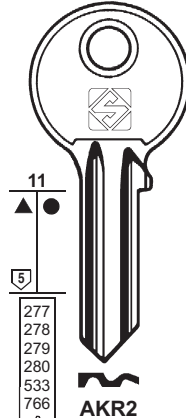

**AKR2**

E .....  
F .....  
K .....  
G .....  
1-2-3-4-5-6-7



LITTO

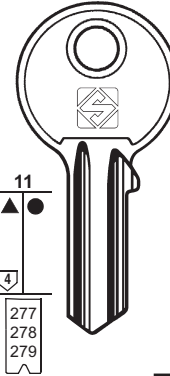

..... 1011-7077

B ..... 1-2-3-4-5-6-7  
E ..... 1-2-3-4-5-6-7  
F ..... 1-2-3-4-5-6-7  
K ..... 1011-7077  
V ..... 1-2-3-4-5-6-7  
K ... 111-888



ANCHOR - LITTO - ODA

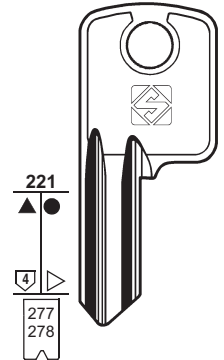

**AKR7**

..... 1011-7077  
B ..... 1-2-3-4-5-6-7  
E ..... 1-2-3-4-5-6-7  
F ..... 1-2-3-4-5-6-7  
K ..... 1011-7077  
K ... 111-888



PER:  
FOR:

## ANKERSLOT

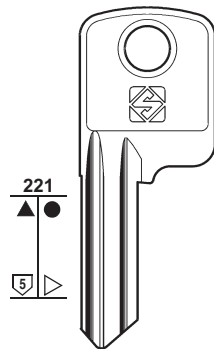

**AKR10**

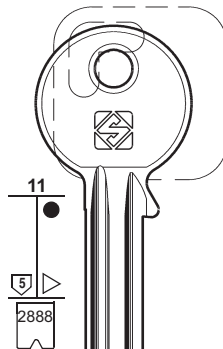

**AKR15**

PK .....  
1-2-3-4-5-6-7

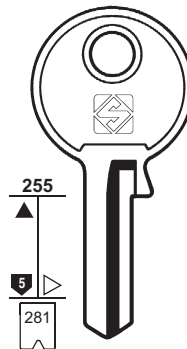

**AKR5**

E .....  
1011-7077

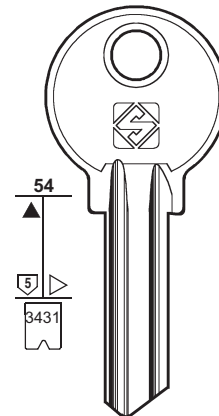

**AKR4**

.....  
A111-GO777

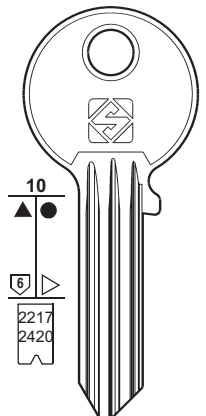

**AKR8**

..... 1-2-3-4-5-6-7-8-9  
N ..... 1 1-28800

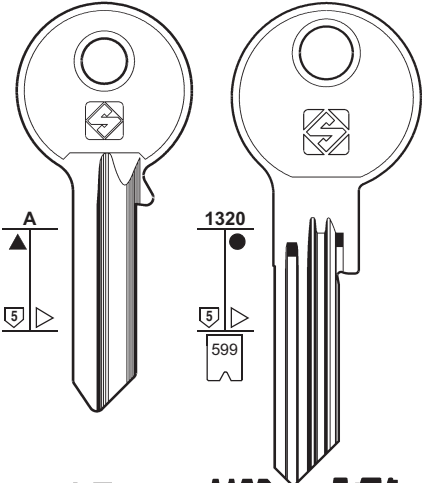
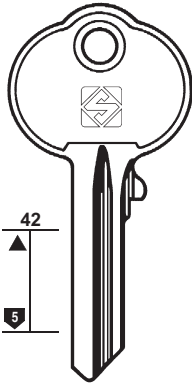
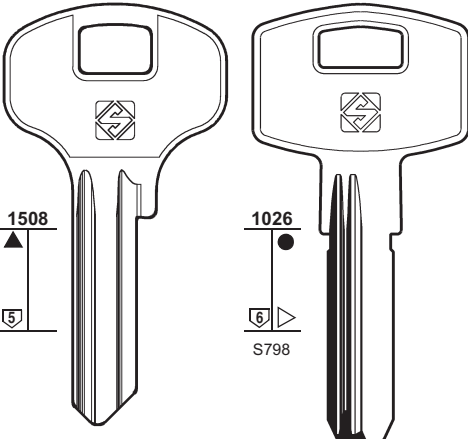

PER: FOR:	ANKERSLOT	ANTAR	APEKS	
	 <p>A</p> <p>1320</p> <p>599</p> <p>AKR9R    AKR11R    AKR14</p> <p>V..... W..... X..... Z..... 1-65535</p>	 <p>42</p> <p>5</p> <p>AN1    AN1R</p> <p>VEGA</p>	 <p>1508</p> <p>5</p> <p>APK1</p> <p>1026</p> <p>S798</p> <p>APK2R</p>	



**17**

- PER / FOR**
- ANKERSLOT (NL)**  
+ ANCHOR (16)  
+ LITTO (113)
  - ANLO (F)**  
+ GLOBE (87)
  - ANTAR (F)**  
VEGA  
+ RONIS (146-147)
  - APEKS (RUS)**
  - AQUILA (I)**
  - AREL (GB) (I)**
  - ARFE (E)**  
STS  
+ FORT (81)  
+ STS (162)
  - ARMOR (F)**  
+ RONIS (147)
  - ARMSTRONG (CZ)**  
+ ABUS (8)
  - ARNOV (F)**  
+ ZENITH (201)
  - AROUCA (BR)**

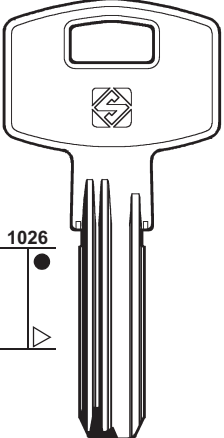
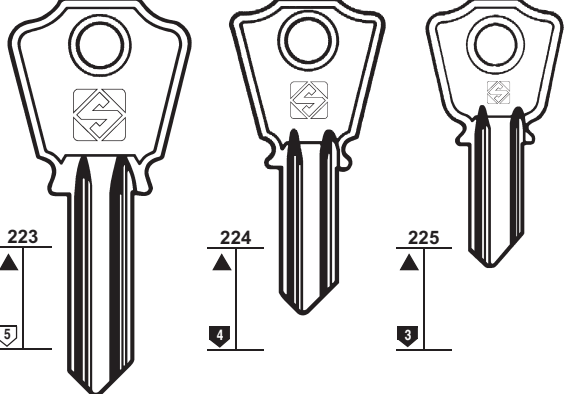
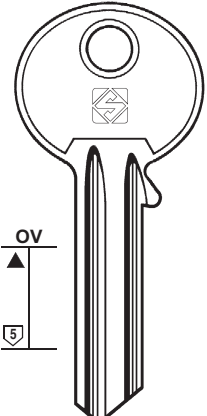
PER: FOR:	APEKS	AQUILA	AREL (GB)
	 <p>1026</p> <p>5</p> <p>APK3R</p>	 <p>223</p> <p>224</p> <p>225</p> <p>5</p> <p>4</p> <p>3</p> <p>AQ1    AQ1R    AQ3    AQ3R    AQ4    AQ4R</p>	 <p>OV</p> <p>5</p> <p>ARE1</p>

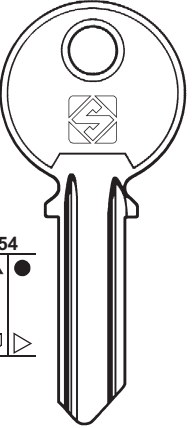
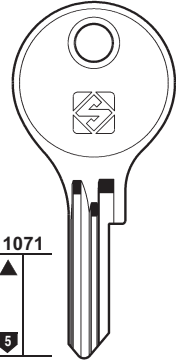
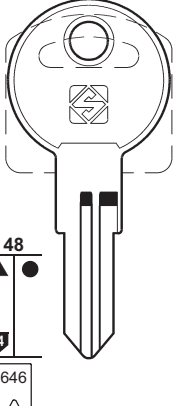
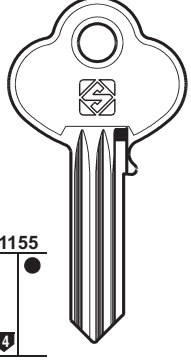
PER: FOR:	AREL (I)	ARFE	ARMSTRONG	AROUCA
	 <p>54</p> <p>5</p> <p>ARL1    ▲ ARL1R</p>	 <p>1071</p> <p>5</p> <p>ARF1</p>	 <p>48</p> <p>4</p> <p>646</p> <p>ART1    ART1R</p> <p>... 101-801</p>	 <p>1155</p> <p>4</p> <p>646</p> <p>..... 1-2-3-4-5-6-7</p> <p>AUC1</p>



# 18

PER / FOR

**AROUCA** (BR)

**ARREGUI** (E)

AGA (10)

FAC (75)

**ARROW** (USA)

ALMET  
AMEROCK  
DOMINION  
FORT  
LG

**ARSENJEVSK** (RUS)

**ASEC SECURITY** (GB)

ALDRIDGE E. (13-14)

**ASIA** (RC)

TWIRHONB

+ YETI (198-199)

**ASIAN** (RC)

**ASPA** (NL)

+ DOM (63)

**ASSA** (S)

TEKA

+ RUKO (148)

PER: **AROUCA**  
FOR:

**AUC4**      **AUC5**      **AUC6**

PER: **ARROW**  
FOR:

**AW1**      **AW3**  
**AW2**      **AW4**      **AW5**  
K7

DOMINION - FORT - LG      AMEROCK

PER: **ARROW**  
FOR:

**AW6**      **AW7**  
K7-5      K2

ALMET      ALMET

PER: **ARSENJEVSK**  
FOR:

**ARS1**      **ARS2**

PER: **ASIA**  
FOR:

**AS1**

mm 45  
TWIRHONB

PER: **ASIAN**  
FOR:

**ASN1**

PER: **ASPA**  
FOR:

**APA1R**      **APA2R**  
2U ... 1-748

PER: **ASSA**  
FOR:

**ASS6**      **ASS6R**      **ASS186**  
22001      20201      20301  
0-1-2-3-4-5-6-7-8-9-A-B-C  
D-0-1-2-3-4-5-6-7-8-9-A-B-C

TEKA

PER:  
FOR:

# ASSA

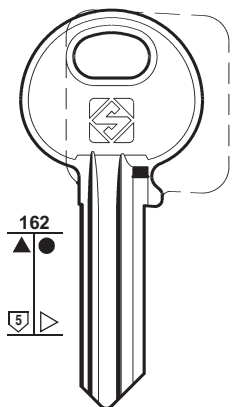

**ASS137**  
22401

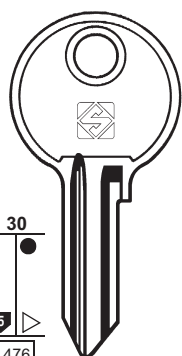

**ASS47**  
21202

... 151-200  
..... 0-1-2-3-4-5-6

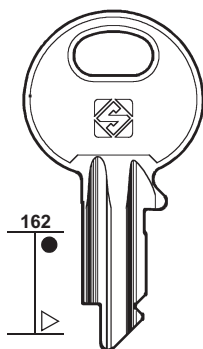

**ASS181**

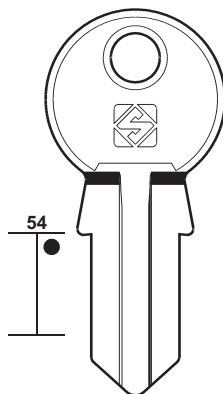

**ASS149**

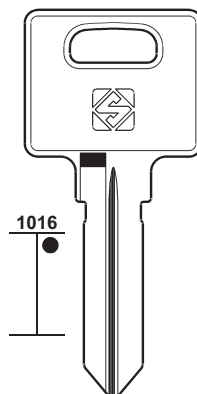

**ASS148**



# 19

PER / FOR

**ASSA (S)**  
+ RUKO (148)

PER:  
FOR:

# ASSA

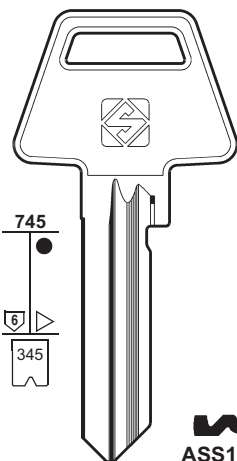

**ASS122R**  
UM

**ASS155**  
PK

**ASS155R**  
UK

**ASS142** TW .....  
123456789  
05-04

**ASS143**  
05-05

**ASS144** TW .....  
123456789  
05-13

**ASS145**  
14-01

**ASS146**  
14-09

**ASS147**  
14-25

**ASS150**  
11-08

**ASS151**  
11-01

**ASS152**  
11-32

**ASS153**  
11-14

**ASS154**  
11-12

**ASS172**  
05-14

**ASS174**  
14-33

**ASS175R**  
UL

**ASS176**  
TM

**ASS177**  
TK

**ASS178**  
TL

PER:  
FOR:

# ASSA

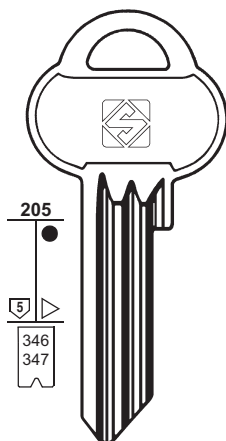

mm 28,7  
560.

..... 1-2-3-4-5-6-7  
..... 1-2-3-4-5-6-7-8

**ASS9R**

**ASS9**

**ASS31R**

**ASS31**

**ASS11**

**ASS11R**

**ASS33**

**ASS33R**

**ASS2**

**ASS2R**

**ASS10R**

**ASS10**



20

PER / FOR

ASSA (S)  
+ RUKO (148)

PER:  
FOR:

ASSA

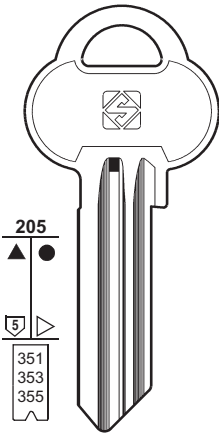

U ASS7

W ASS7R

D ASS64

H ● ASS64R

V ● ASS35R

T ● ASS35

RR ASS69

SS ▲ ASS69R

Z ▲ ASS37

X ASS37R

MM ASS68R

NN ASS44

PP ASS44R

FG ● ASS180R

5FG . . . . . 10000-99809

. . . . . 1-2-3-4-5-6-7  
. . . . . 1-2-3-4-5-6-7-8

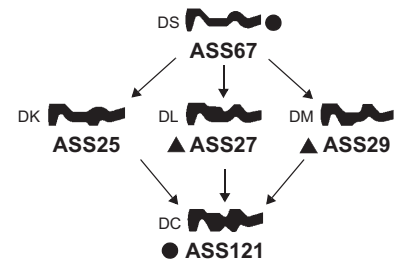
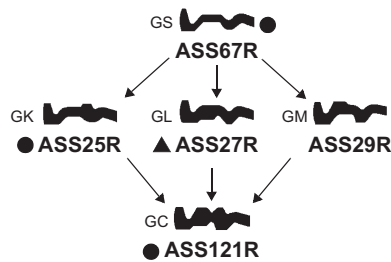
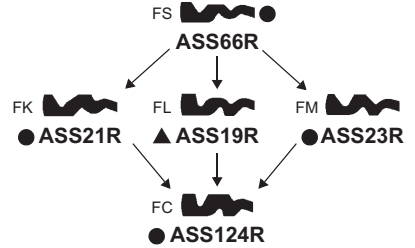
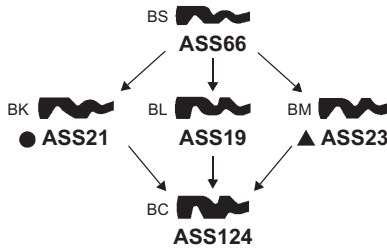
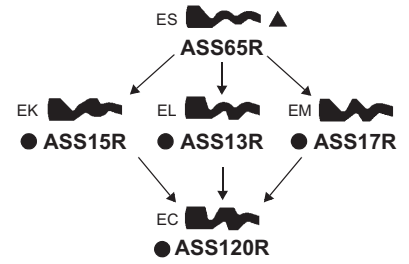
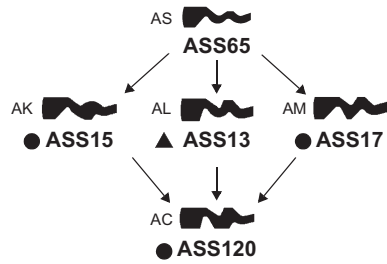

PER:  
FOR:

# ASSA



# 21

PER / FOR

ASSA (S)  
+ RUKO (148)

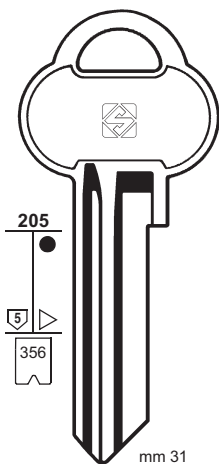

560.  
..... 1-2-3-4-5-6-7

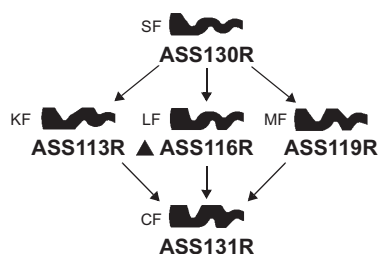
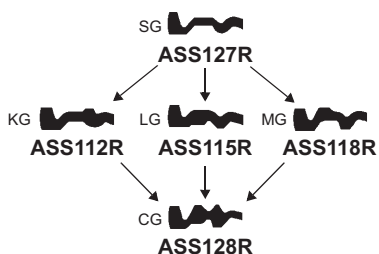
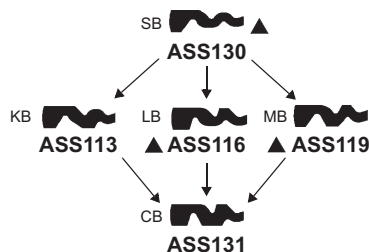
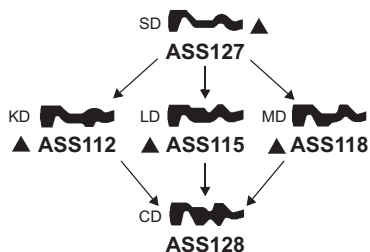
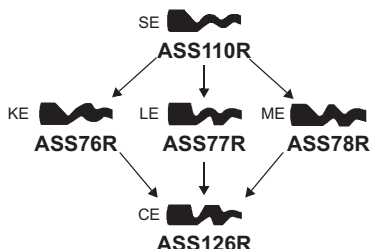
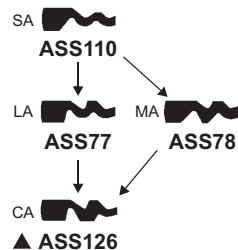

PER:  
FOR:

# ASSA

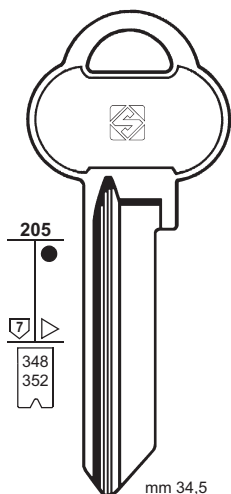

760.  
..... 1-2-3-4-5-6-7

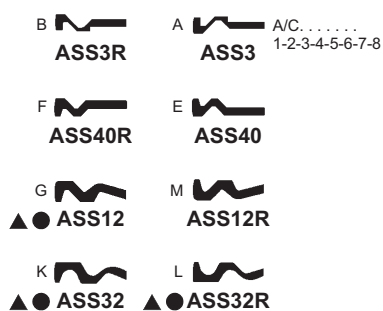



22

PER / FOR

ASSA (S)  
+ RUKO (148)

PER:  
FOR:

ASSA

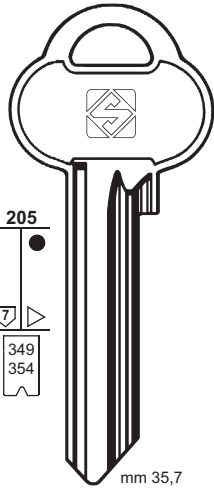

mm 35,7

760.

GG  
ASS108

..... 1-2-3-4-5-6-7  
..... 1-2-3-4-5-6-7-8

- D ASS4      H ASS4R
- U ASS8      W ASS8R
- V ASS34R      T ASS34
- Z ASS36      X ASS36R
- NN ASS45      PP ASS45R
- RR ASS39      SS ASS39R
- KK ASS109      MM ASS48R

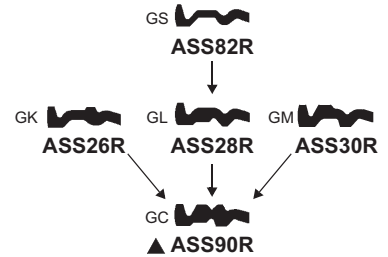
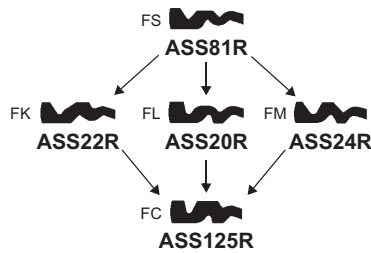
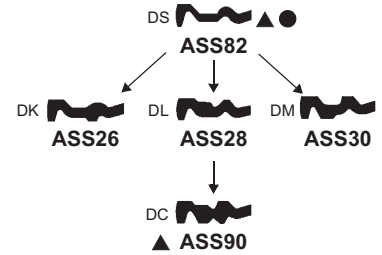
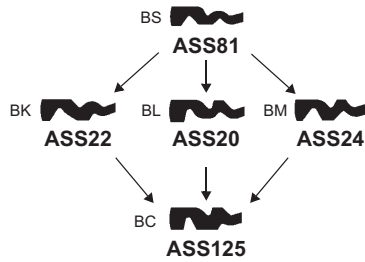
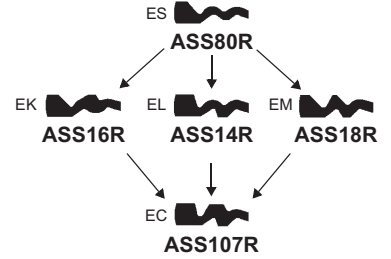
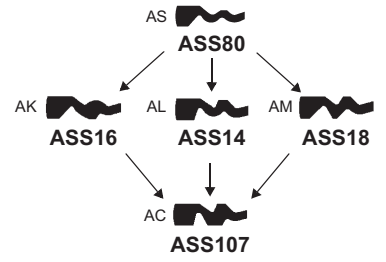

PER:  
FOR:

# ASSA



# 23

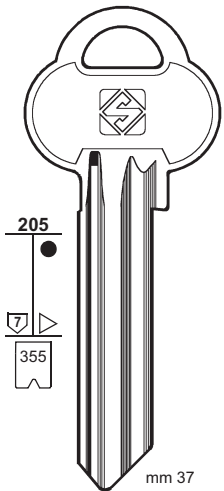

1DG ..... 1-83499  
 0FG ..... 10000-99809  
 0DG ..... 1-99999  
 DS ..... 1-78678  
 DJ ..... 1-1234567  
 SE ..... 00001-43800  
 ..... 1-2-3-4-5-6-7  
 ..... 1-78670

- |                  |                        |
|------------------|------------------------|
| DD <b>ASS52</b>  | HH <b>ASS52R</b> ▲ ● ⊕ |
| PA <b>ASS102</b> | PB <b>ASS102R</b>      |
| PD <b>ASS183</b> | PE <b>ASS183R</b>      |
| PF <b>ASS103</b> | PG <b>ASS103R</b>      |
| PH <b>ASS104</b> | PN <b>ASS104R</b>      |
| PR <b>ASS105</b> | PT <b>ASS105R</b>      |
| UU <b>ASS94</b>  | WW <b>ASS94R</b>       |
| VV <b>ASS51</b>  | TT <b>ASS51R</b>       |
|                  | XX <b>ASS106R</b>      |

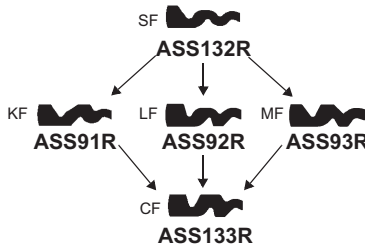
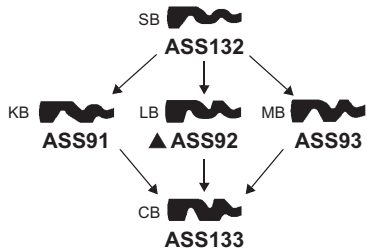
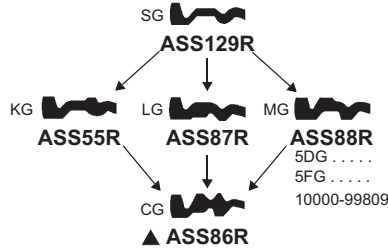
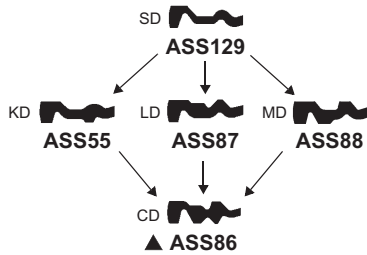
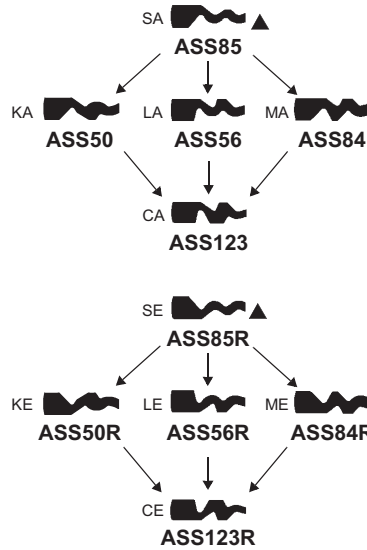

PER / FOR

**ASSA** (S)  
 + RUKO (148)

**ASTRA** (AUS)

**ATAL** (F)  
 KIFERM (106)  
 LAS (110)  
 L & F (116)  
 RENZ (145)  
 VACHETTE (181)

**ATAY** (RUS)

**ATLAS** (F)  
 SUREX (163)

**ATP** (I)  
 CITY (51)

**AUBERT** (F)  
 ZENITH (201)

**AUMON** (E)

PER:  
FOR:

## ASTRA

## ATAY

## AUMON

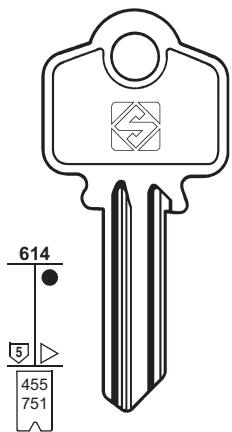

**AT1**  
 ..... 0-1-2-3-4-5-6-7  
 ..... 1-2-3-4-5-6-7-8

**AT1R**  
 ..... 1-2-3-4-5-6-7-8

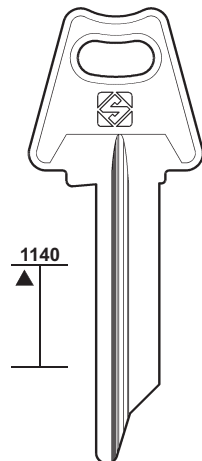

**ATA1**

**ATA1R**

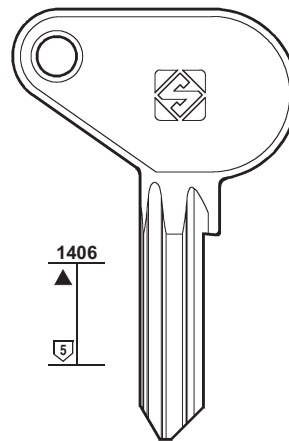

**AUN1**



24

PER / FOR

AUSTRAL LOCK (AUS)

AVA-CHUBB (S)

AVANGARD (RUS)

AVOCET (GB)  
W.M.S.

AXA (NL)

AZBE (E)  
CAVERS  
+ TOK-WINKHAUS (171)

PER: AUSTRAL LOCK  
FOR:

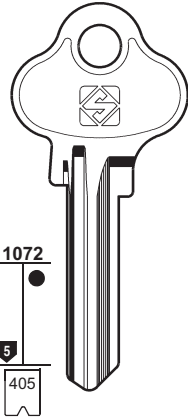

AUS1

..... 0-1-2-3-4-5-6-7-8-9-A

PER: AVA-CHUBB  
FOR:

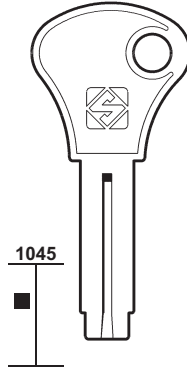

CHU7



PER: AVANGARD  
FOR:

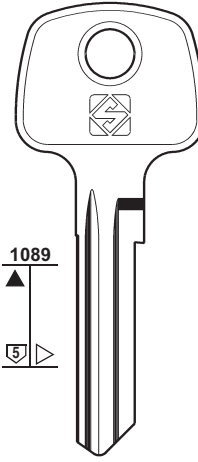

AV1

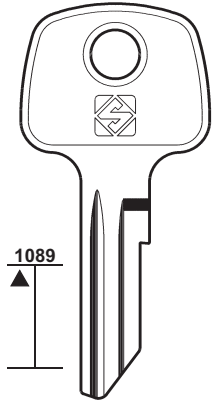

AV1R



AV2

PER: AVOCET  
FOR:

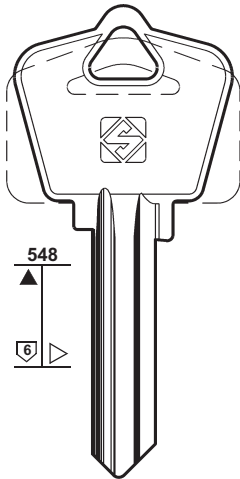

AVC1

W.M.S.

PER: AXA  
FOR:

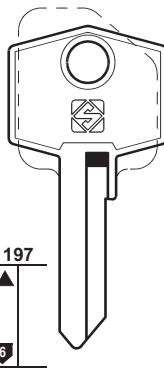

AX2

PER: AZBE  
FOR:

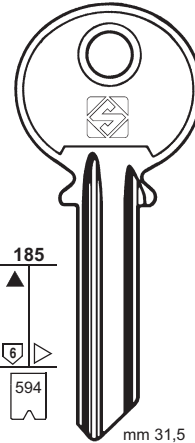

AZ1  
X

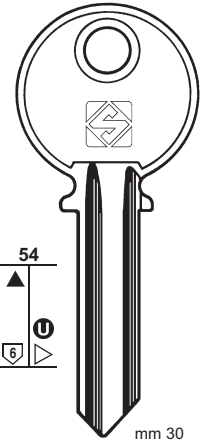

AZ1R  
Y



AZ3



AZ3R

X .....  
Y .....  
1-2-3-4-5-6-7-8

PER: AZBE  
FOR:

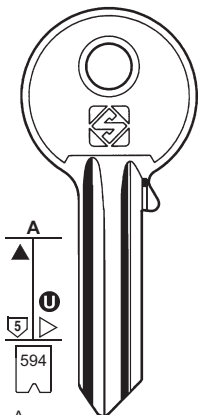

A ..... mm 26,3  
B .....  
1-2-3-4-5-6-7-8



AZ2

A



AZ2R

B

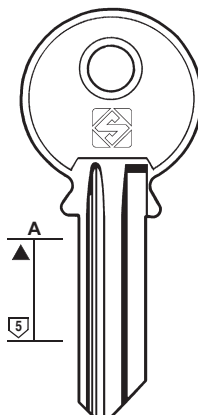

AZ4

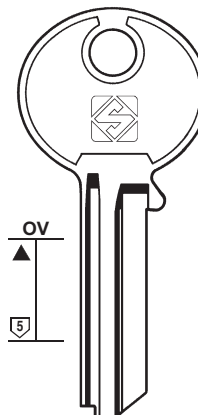

AZ5

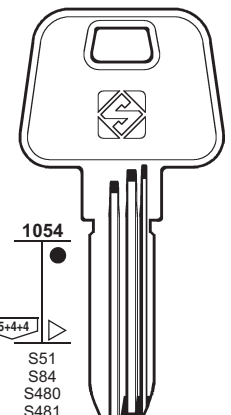

AZ6

HS-4



AZ6R



CAVERS



PER:  
FOR:

### AZBE

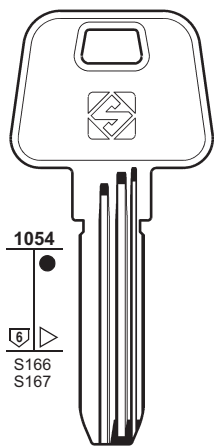

**AZ7**  
HS-6

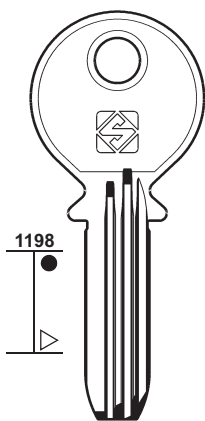

**AZ8**

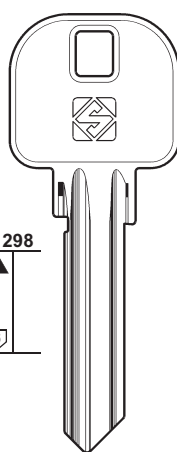

**AZ9**   **AZ9R**

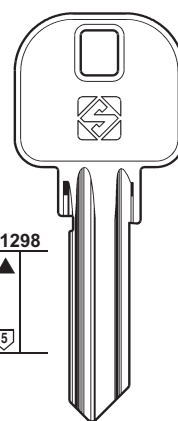

**AZ10**   **AZ10R**



# 25

PER / FOR

**AZBE** (E)  
CAVERS  
+ TOK-WINKHAUS (171)

**AZMA** (F)  
VACHETTE (184)

**BAAL** (CH)  
VÖGEL

**BAB** (D)  
ESS

PER:  
FOR:

### BAAL

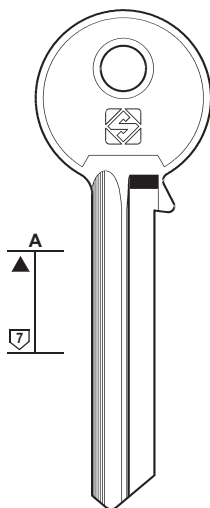

**BAL7**

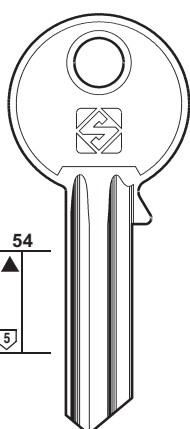

**BAL5**

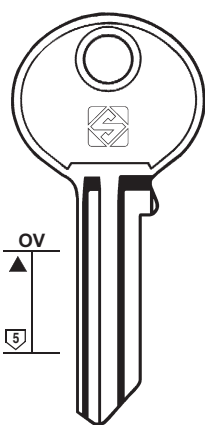

**BAL1**   **BAL1R**

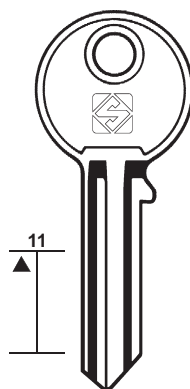

**BAL2**

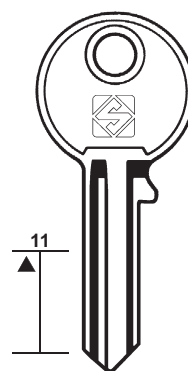

**BAL3**

VÖGEL

PER:  
FOR:

### BAAL

### BAB

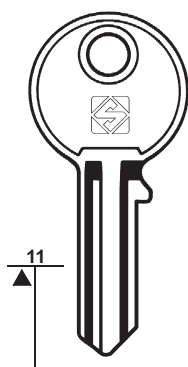

**BAL4**

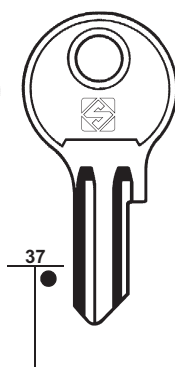

**BAL6**

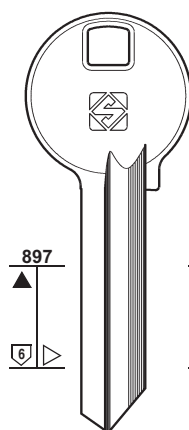

**BAB6R**

**BAB7R**

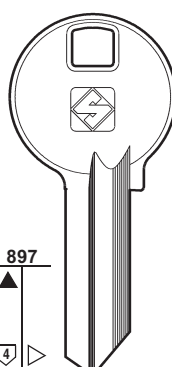

**BAB4R**

**BAB5R**

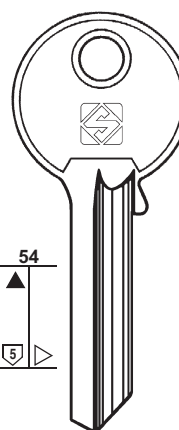

**BAB2R**

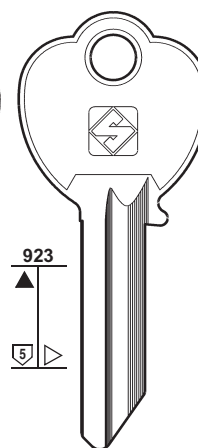

**BAB18R**

ESS



26

PER / FOR

BAB (D)  
CORONA  
HALLE  
ZEISS-IKON

PER:  
FOR:

BAB

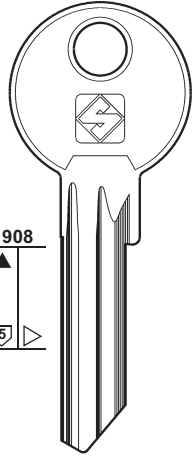

BAB14

ZEISS-IKON

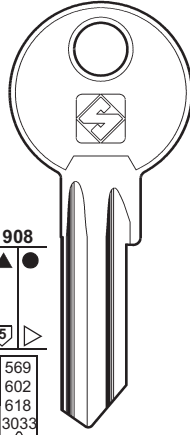

BAB13

CORONA - ZEISS-IKON

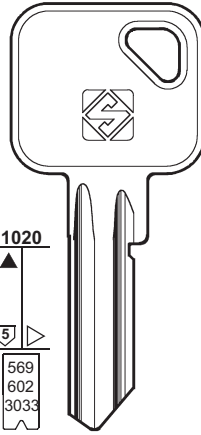

BAB13R

1-2-3-4-5-6-7-8-9-0  
135679ACEGI

1-2-3-4-5-6-7-8-9-0  
135679ACEGI

1234567890ABCDEFGHIJL

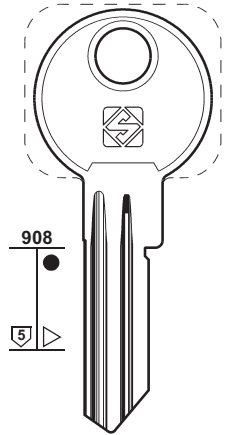

BAB27

BAB29

BAB28R

PER:  
FOR:

BAB

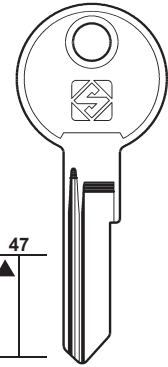

BAB15

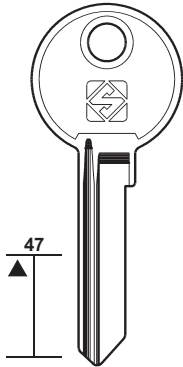

BAB16

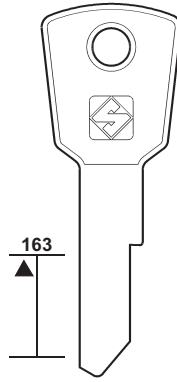

BAB19

HALLE

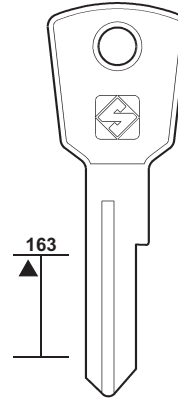

BAB20

HALLE

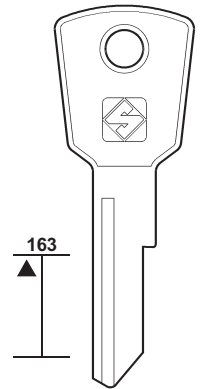

BAB21-3

BAB21-4

BAB21-5

HALLE

PER:  
FOR:

BAB

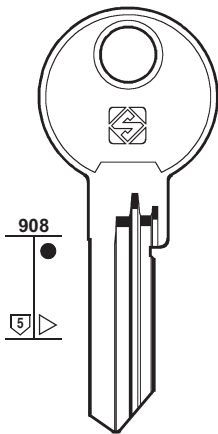

BAB26R-1

BAB26R-2

BAB26R-3

BAB26R-4

BAB26R-5

BAB26R-6

BAB26R-7

BAB26R-8

BAB26R-9

BAB26R-10

BAB26R-11

BAB26R-12

BAB26R-13

BAB26R-14

BAB26R-15

BAB26R-16

BAB26R-17

<b>PER: FOR:</b>	<b>BAB</b>		<b>BABY CLIP</b>
	 908  <b>BAB30R-5</b> <b>BAB30R-6</b> <b>BAB30R-7</b> <b>BAB30R-8</b> <b>BAB30R-9</b> <b>BAB30R-10</b> <b>BAB30R-11</b> <b>BAB30R-1</b> <b>BAB30R-2</b> <b>BAB30R-3</b> <b>BAB30R-4</b>	 OV  <b>BAB31</b> N26	 11  <b>BC1</b> <b>BC1R</b>  <b>EFSA - ETF</b>

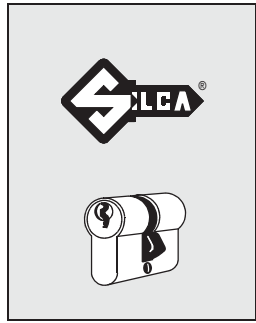

# 27

<b>PER / FOR</b>
<b>BAB</b> (D)
<b>BABY CLIP</b> (F) EFSA ETF
<b>BAGEM</b> (E) ABC (4)
<b>BALDWIN</b> (USA) SCHLAGE (151-152)
<b>BALLY</b> (I) TAMPALINI (164) ZANI (200)
<b>BANE SEKULIĆ</b> (SGC) BSS (36)
<b>BANHAM</b> (GB) SIDLEEN (154)
<b>BANKA</b> (I) GIUSSANI (87)
<b>BAODEAN</b> (PRC)
<b>BAODELI</b> (PRC)
<b>BARAS</b> (GR)
<b>BARGMAN</b> (USA) ILCO (96)
<b>BARRO</b> (D) DOM (61)
<b>BASI</b> (D) + ABUS (8) + BUGA (36) + CISA (50-51) + EURO-LOCKS (71) + L & F (117)

<b>PER: FOR:</b>	<b>BANHAM</b>	<b>BAODEAN</b>	<b>BAODELI</b>
	 A  <b>BM1</b> THIN <b>BM2</b> THIK	 1577  <b>BAE1</b>	 1560  <b>BAD1</b> <b>BAD1R</b>

<b>PER: FOR:</b>	<b>BARAS</b>	<b>BASI</b>			
	 56  <b>BAR1</b> <b>BAR1R</b>	 959  <b>BAI2</b>	 963  <b>BAI3</b>	 37  <b>BAI4R</b>	 A  <b>BAI5R</b>
			mm 40	mm 50	



28

PER / FOR

- BASI (D)**
- CIC
- + ABUS (8)
- + BUGA (36)
- + CISA (50-51)
- + EURO-LOCKS (71)
- + L & F (117)

**BASCO (USA)**  
BIZERBA  
ELMO

**BASSI (I)**

**BASTA (IRL)**

**BASTA (DK)**  
EURO LOCKS

**BATON (RC)**

PER:  
FOR:

**BASI**

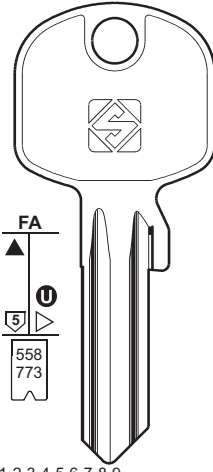

FA  
5  
558  
773



**BAI1**

..... 1-2-3-4-5-6-7-8-9  
..... 1-2-3-4-5-6-7-8-9-0  
..... 800001-803640

CIC

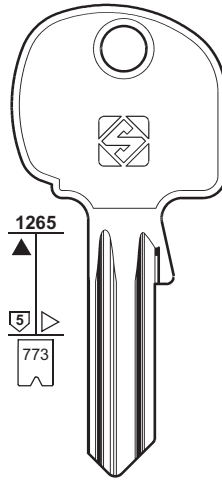

1265  
5  
773



**BAI7**

..... 1-2-3-4-5-6-7-8-9-0  
..... 800001-803640

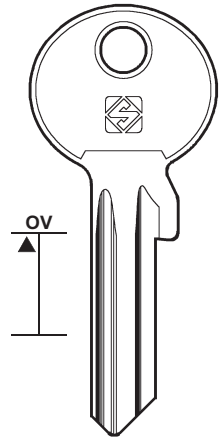

OV



**BAI23**

PER:  
FOR:

**BASCO**

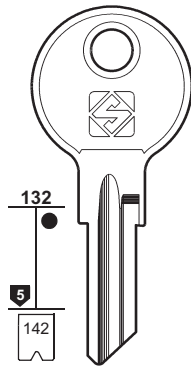

132  
5  
142



**BA1**



**BA8**

C ..... 1701-1950  
C ..... 1951-2200  
C ..... 250-499  
C ..... 500-699

ELMO

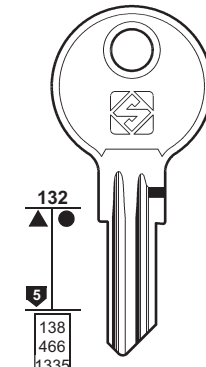

132  
5  
138  
466  
1335



**BA5**

..... 101-350  
AN ..... 1-500  
HC ..... 0-499  
LL ..... 1-326  
LL ..... 1-200  
LL ..... 1-200  
DD ..... 1-250  
GC ..... 101-150  
CH ..... 751-1178  
RC ..... 501-750

BIZERBA - ELMO



**BA5R**

..... CH 501-750  
EM ..... 501-750

**BASSI**

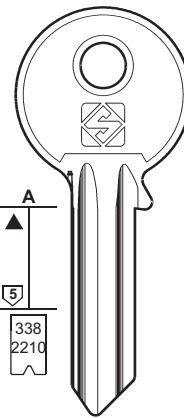

A  
5  
338  
2210



**TP1**

..... 0-1-2-3-4-5  
..... 1-2-3-4-5

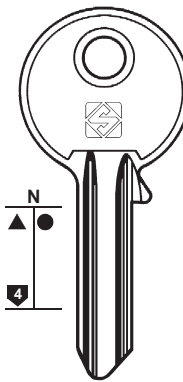

N  
4



**BSI2R**

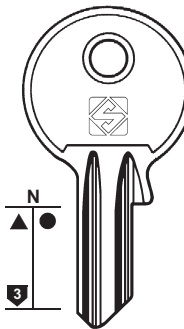

N  
3



**BSI1**



**BSI4**



**BSI4R**



**BSI1R**

PER:  
FOR:

**BASTA (IRL)**

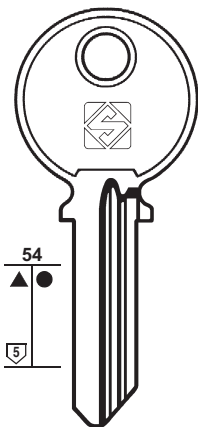

54  
5



**BAS1**

**BASTA (DK)**

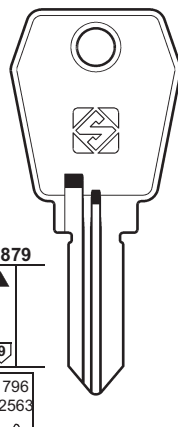

879  
9  
796  
2563



**BAS4R**

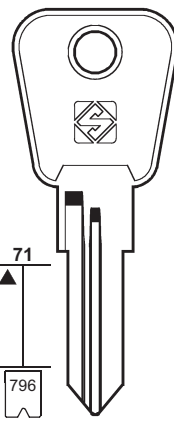

71  
796



**BAS5R**

M ..... 1-1000  
V ..... 1-1000  
W ..... 1-1000  
C ..... 1-1000

EURO LOCKS

Copyright by Silca S.p.A. 2013 - All rights reserved

**BATON**

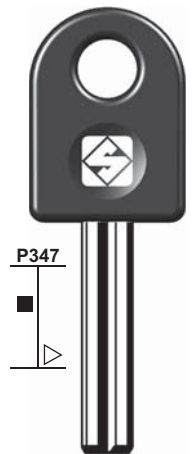

P347



**BAT1P**



PER: FOR:	BATON	BECCARINI	BELLEVILLE	BELL
	 BAT2	 BN2    BN2R	 BLV3	 BLL1    BLL3

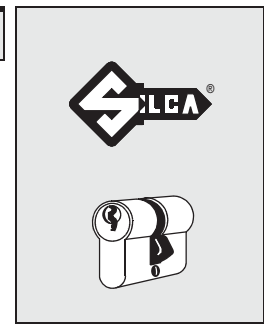

# 29

PER / FOR
<b>BATON</b> (RC)
<b>BATU</b> (E) CISA (50) IFAM (95)
<b>BECCARINI</b> (I)
<b>BEDI</b> (F) YETI (198-199)
<b>BELLEVILLE</b> (USA)
<b>BELL</b> (RC) +  YETI (198-199)
<b>BENCO</b> (NL) YETI (199)
<b>BENDIX</b> (USA) YALE (194)
<b>BERAM</b> (RC) VIRO (187)
<b>BERETTA</b> (I) FASEM (77)
<b>BERRY</b> (D) BKS (30) CES (42)
<b>BERTO</b> (CH)
<b>BERTOLOTTI</b> (I) TICINO (166)
<b>BEST</b> (USA) FALCON
<b>BETA</b> (I) PICARD +  CORNI (55)
<b>BEY</b> (TR)
<b>BIB</b> (I) MERONI (123)
<b>BIBERING</b> (D) TAS (165)

PER: FOR:	BERTO	BEST	BETA																																		
	 BRT1	<table border="0"> <tr> <td>A </td> <td>H </td> </tr> <tr> <td>▲● BES1</td> <td>BES8</td> </tr> <tr> <td>..... 0-1-2-3-4-5-7-8-9</td> <td></td> </tr> <tr> <td>..... 0-1-2-3-4-5</td> <td></td> </tr> <tr> <td>..... 0-1-2-3-4-5-6-7-8-9</td> <td></td> </tr> <tr> <td>B </td> <td>J </td> </tr> <tr> <td>BES2</td> <td>BES9</td> </tr> <tr> <td>C </td> <td>K </td> </tr> <tr> <td>BES3</td> <td>BES10</td> </tr> <tr> <td>D </td> <td>L </td> </tr> <tr> <td>BES4</td> <td>BES11</td> </tr> <tr> <td>E </td> <td>FM </td> </tr> <tr> <td>BES5</td> <td>BES12</td> </tr> <tr> <td>F </td> <td>M </td> </tr> <tr> <td>▲● BES6</td> <td>BES18</td> </tr> <tr> <td>G </td> <td></td> </tr> <tr> <td>BES7</td> <td></td> </tr> </table>	A	H	▲● BES1	BES8	..... 0-1-2-3-4-5-7-8-9		..... 0-1-2-3-4-5		..... 0-1-2-3-4-5-6-7-8-9		B	J	BES2	BES9	C	K	BES3	BES10	D	L	BES4	BES11	E	FM	BES5	BES12	F	M	▲● BES6	BES18	G		BES7		 ..... 1-2-3-4-5-6      ..... 1-2-3-4-5-6
A	H																																				
▲● BES1	BES8																																				
..... 0-1-2-3-4-5-7-8-9																																					
..... 0-1-2-3-4-5																																					
..... 0-1-2-3-4-5-6-7-8-9																																					
B	J																																				
BES2	BES9																																				
C	K																																				
BES3	BES10																																				
D	L																																				
BES4	BES11																																				
E	FM																																				
BES5	BES12																																				
F	M																																				
▲● BES6	BES18																																				
G																																					
BES7																																					
		FALCON	PICARD																																		

PER: FOR:	BETA	BEY
	 BE4R ..... 1-2-3-4-5-6	 BEY1R    BEY2R



30

PER / FOR

**BIELLE** (I)  
FASEM  
OMIV  
P.C.

**BIFFAR** (D)  
TOK-WINKHAUS (171)

**BILMA** (E)

**BIGLA** (CH)

**BIRD** (HK)  
YALE (193)

**BIZERBA** (HK)  
BASCO (28)

**BKS** (D)  
BERRY  
DAMM  
GEBÄ  
HÄFELE  
HÖHRMANN  
YALE  
+ LITTO (113)  
+ YALE (193-194)

PER: FOR:	BIELLE	BILMA	BIGLA
	FASEM - OMIV - P.C.		

PER:  
FOR:

**BKS**

Serie O  
BERRY - DAMM - GEBÄ - HÖHRMANN - YALE

1234567890ABCDEF GHI L  
0212 0213 0214 0215 0217 0219 0201 0202 0209 0207

PER:  
FOR:

**BKS**

HÄFELE

PER:  
FOR:

### BKS

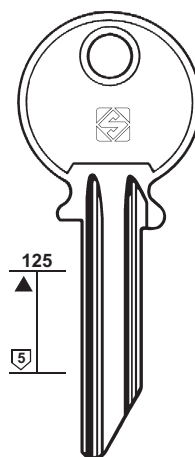
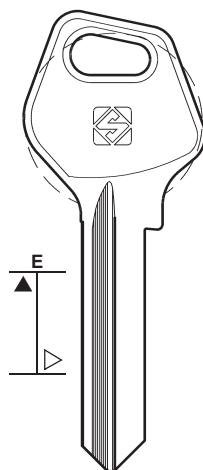
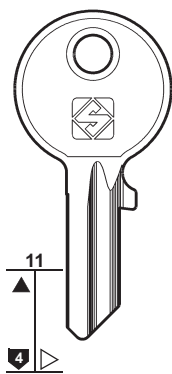
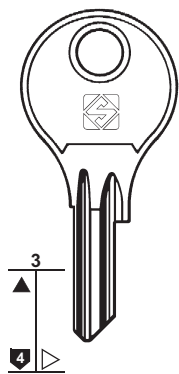

BK4



BK4R

34



BK8



BK8R



BK11R



BK26



LT1

METEOR - YALE



# 31

PER / FOR

**BKS (D)**  
METEOR  
YALE  
+ LITTO (113)  
+ YALE (193-194)

PER:  
FOR:

### BKS

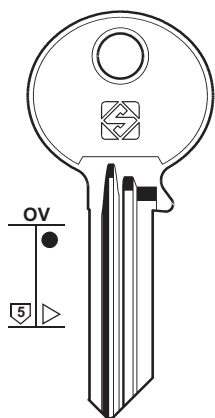

Serie 1000



BK5-1



BK5-9



BK5-17



BK5-25



BK5-33



BK5-2



BK5-10



BK5-18



BK5-26



BK5-34



BK5-3



BK5-11



BK5-19



BK5-27



BK5-35



BK5-4



BK5-12



BK5-20



BK5-28



BK5-5



BK5-13



BK5-21



BK5-29



BK5-6



BK5-14



BK5-22



BK5-30



▲ BK5-7



BK5-15



▲ BK5-23



BK5-31



BK5-8



BK5-16



BK5-24



BK5-32

PER:  
FOR:

### BKS

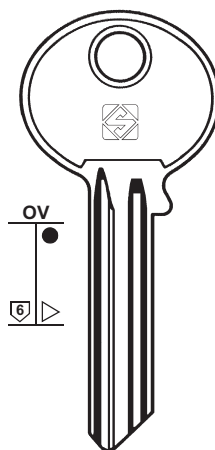

Serie 1000



BK6-1



BK6-9



▲ BK6-17



BK6-25



BK6-33



BK6-2



BK6-10



BK6-18



BK6-26



BK6-34



BK6-3



BK6-11



BK6-19



BK6-27



BK6-35



BK6-4



BK6-12



BK6-20



BK6-28



BK6-5



BK6-13



BK6-21



BK6-29



BK6-6



BK6-14



BK6-22



BK6-30



BK6-7



BK6-15



BK6-23



BK6-31



BK6-8



BK6-16



▲ BK6-24



BK6-32



32

PER / FOR

**BKS** (D)

+ LITTO (113)

+ YALE (193-194)

**BLASER** (CH)

VADETO

WILKA

**BLINKY** (PRC)

**BLOCKSHAFT** (I)

**BLOCTOUT** (F)

+ BRICARD (35)

**BLOCUS** (F)

+ PREFER (142)

+ RONIS (146)

**BMB** (D)

**BODA** (FIN)

+ CES (41-42-43-44)

PER:  
FOR:

**BKS**

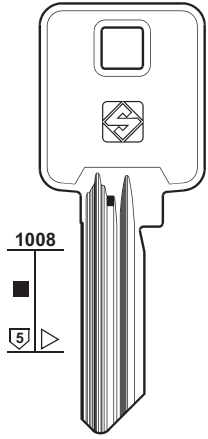

1008



**BK10-00**  
Serie 2000

**BK10-01**

**BK10-07**

**BK10-13**

**BK10-19**

**BK10-02**

**BK10-08**

**BK10-14**

**BK10-20**

**BK10-03**

**BK10-09**

**BK10-15**

**BK10-21**

**BK10-04**

**BK10-10**

**BK10-16**

**BK10-22**

**BK10-05**

**BK10-11**

**BK10-17**

**BK10-23**

**BK10-06**

**BK10-12**

**BK10-18**

**BK10-30**

PER:  
FOR:

**BLASER**

**BLINKY**

**BLOCKSHAFT**

**BLOCUS**

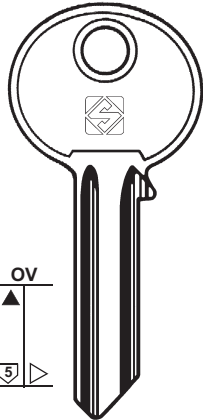

OV



**BLA3**

**BLA1**

**BLA2**  
WILKA

VADETO

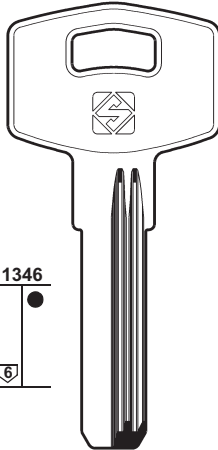

1346



**BNK1**

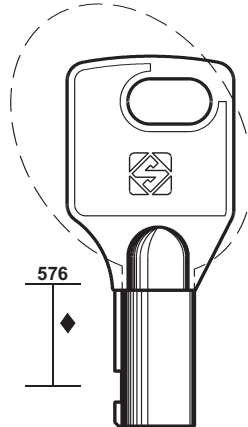

576

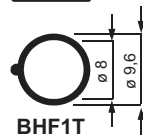

**BHF1T**

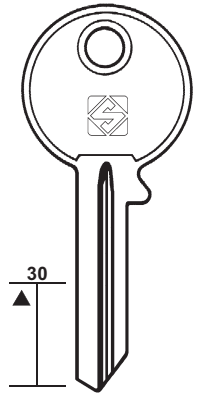

30

**BL1**

**BL1R**

PER:  
FOR:

**BMB**

**BODA**

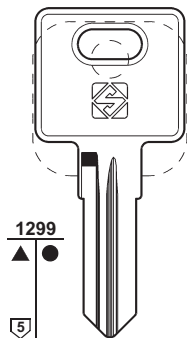

1299



**BMB1**

**BMB1R**

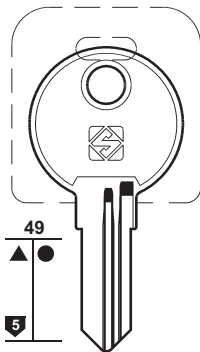

49



**BMB2**

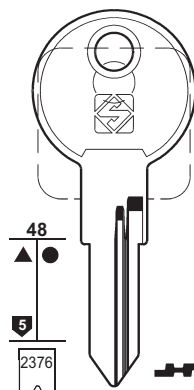

48



**BMB3**  
A ... 1-200

**BMB5**  
A ... 401-600

**BMB3R**  
A ... 1-200

**BMB4**  
A ... 201-400

**BMB4R**  
... 1-2-3

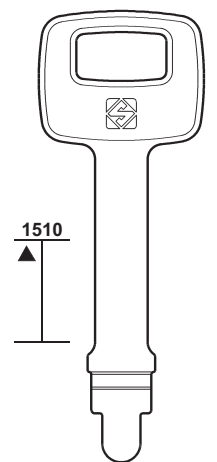

1510

**BDA10**



PER: FOR:	BOMMER	BOMORO	BÖRKEY
	  BOR1 BOR1R	  BO2 BO2R LAPORTE - PRESTA	  BO6 BO6R HUWIL  BY1

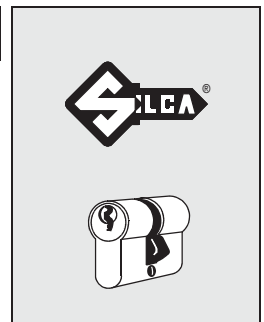

**33**

PER / FOR
<b>BOMMER</b> (USA)
<b>BOMORO</b> (D) HUWIL LAPORTE PRESTA
<b>BÖRKEY</b> (D) +  KABA (102)
<b>BOSS</b> (I) MARLIN
<b>BOTT</b> (F) CES (42)
<b>BRABANTIA</b> (E) CLAUSOR (51) ME-FA (122)
<b>BRASIL</b> (BR)

PER: FOR:	BOSS	BRASIL
	  BOS1 BOS3  mm 60 MARLIN mm 70-90	   BRA1R BRA2R BRA3R

PER: FOR:	BRASIL			
	 BRA16R	 BRA7R ..... 1-2-3-4-5 ..... 1-2-3-4-5-6	 BRA9R	 BRA10R



34

PER / FOR

BRASIL (BR)

BRETER (I)  
GIUSSANI  
ZADI

+ GIUSSANI (86)

PER:  
FOR:

### BRASIL

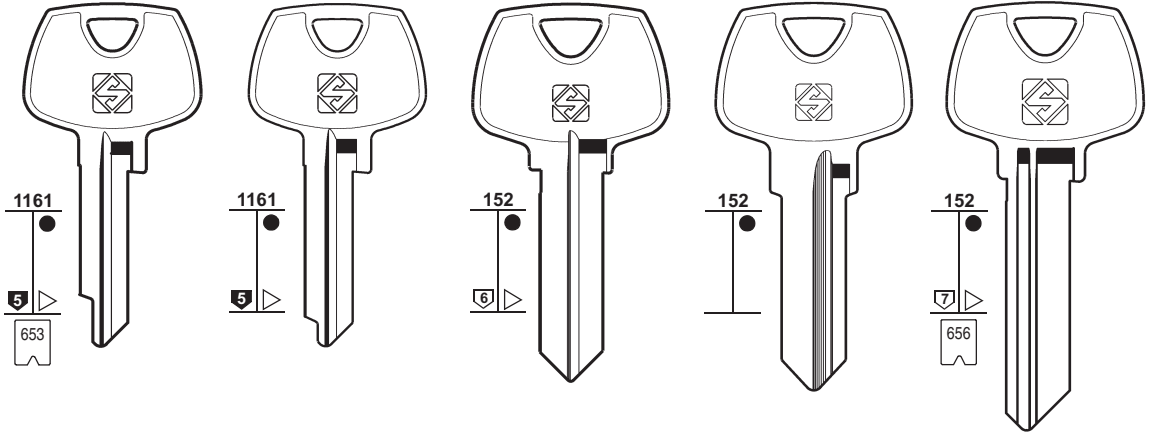

BRA6R

..... 1-2-3-4-5-6



BRA11R



BRA8R



BRA15R



BRA5

..... 1-2-3-4-5-6-7

PER:  
FOR:

### BRETER

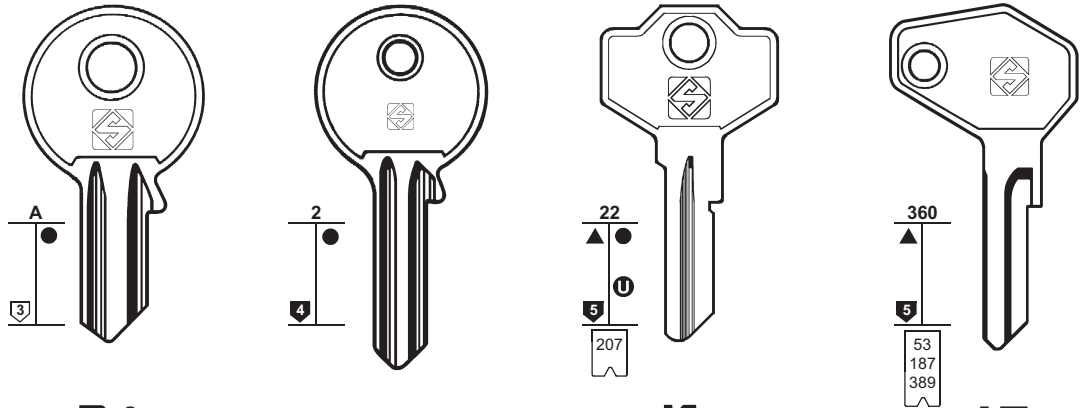

BR1



GS3



GS3R



SM1

G... 0-480  
... 3001-3480  
G... 3001-3480  
... 9001-9741  
G... 9001-9741



ZD7

... 0001-1625  
E... 1-500  
... 501-710  
... 9001-9500



GIUSSANI



GIUSSANI



ZADI

PER:  
FOR:

### BRETER

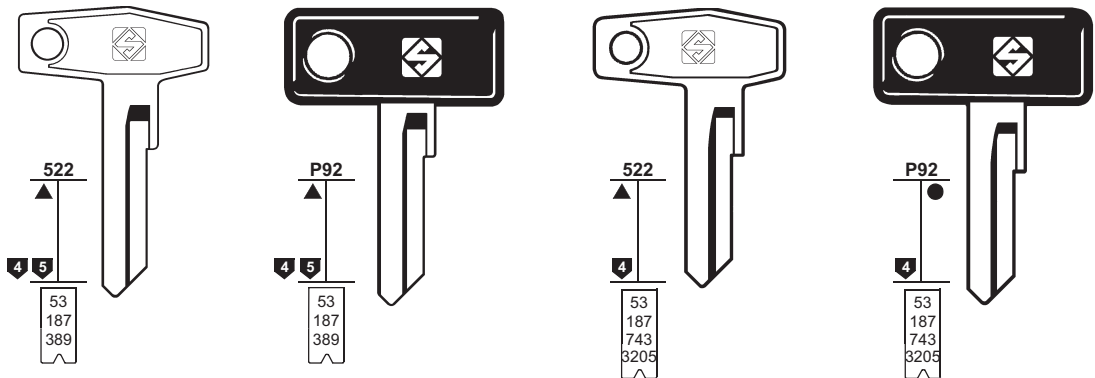

ZD9

... 1-1625  
E... 500  
... 501-710  
... 9001-9500  
... 5001-6278



ZD9P

... 1-1625  
E... 500  
... 501-710  
... 9001-9500  
... 5001-6278



ZD11

... 1-1625  
E... 1-500  
... 5001-6278  
E... 501-710  
... 1234  
H... 100-341



ZD11P

... 1-1625  
E... 1-500  
... 5001-6278  
E... 501-710  
... 1234  
H... 100-341



ZADI



ZADI



PER:  
FOR:

# BRICARD

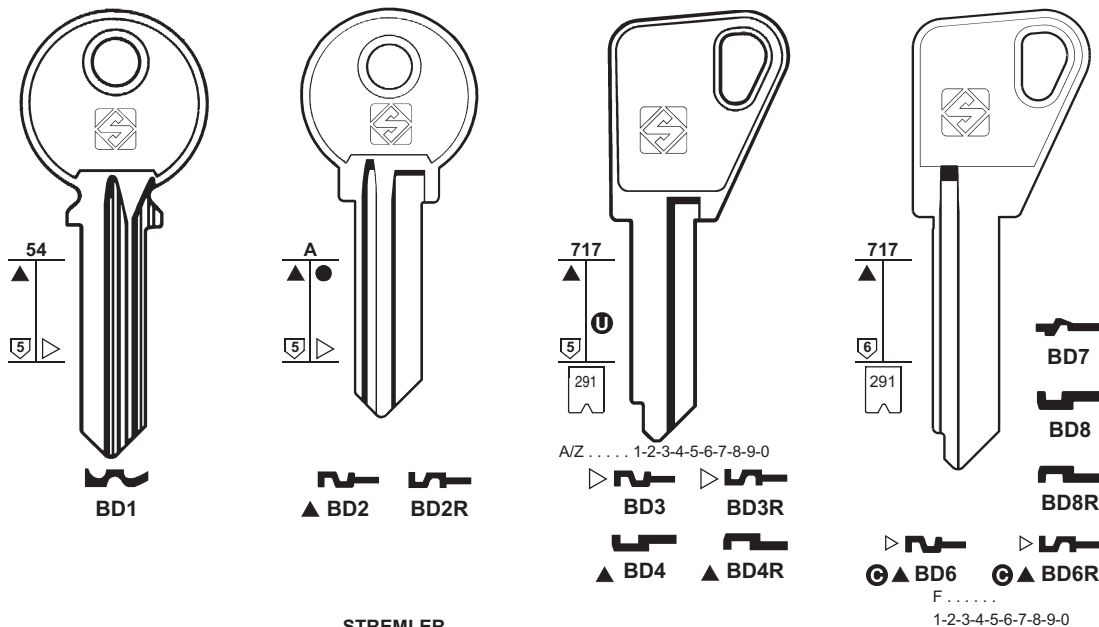

# 35

PER / FOR

- BRICARD (F)**  
 ABUS  
 BLOCTOUT  
 INLOC  
 STREMLER  
 + ABUS (7-10)  
 + CISA (48-49)  
 + G.R. (90)  
 + KWIKSET (108)  
 + LOB (114)  
 + SARGENT (150)

PER:  
FOR:

# BRICARD

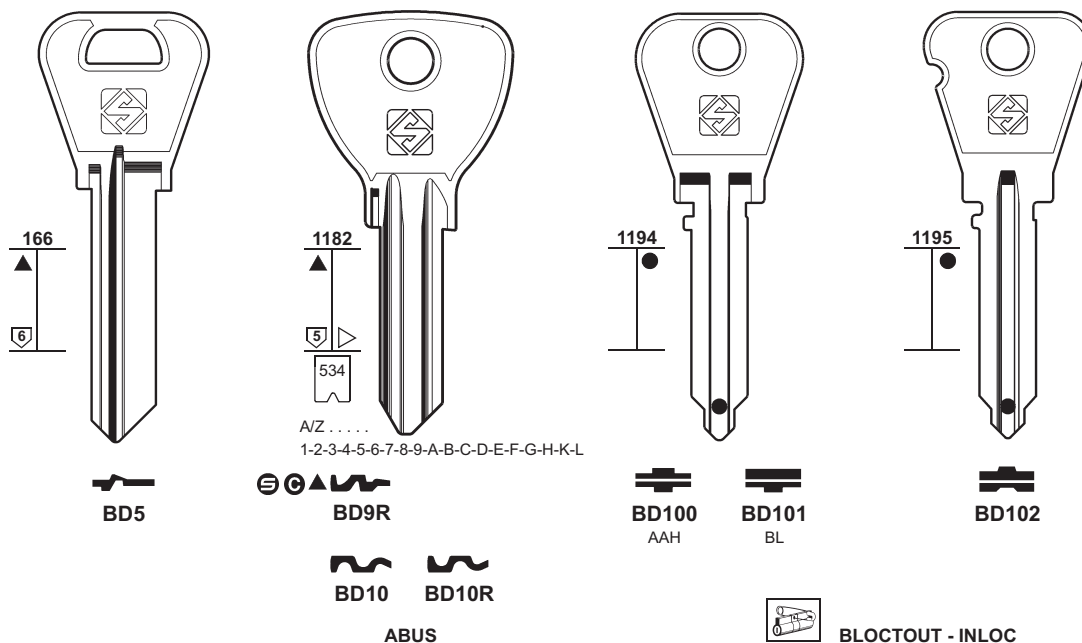

PER:  
FOR:

# BRICARD

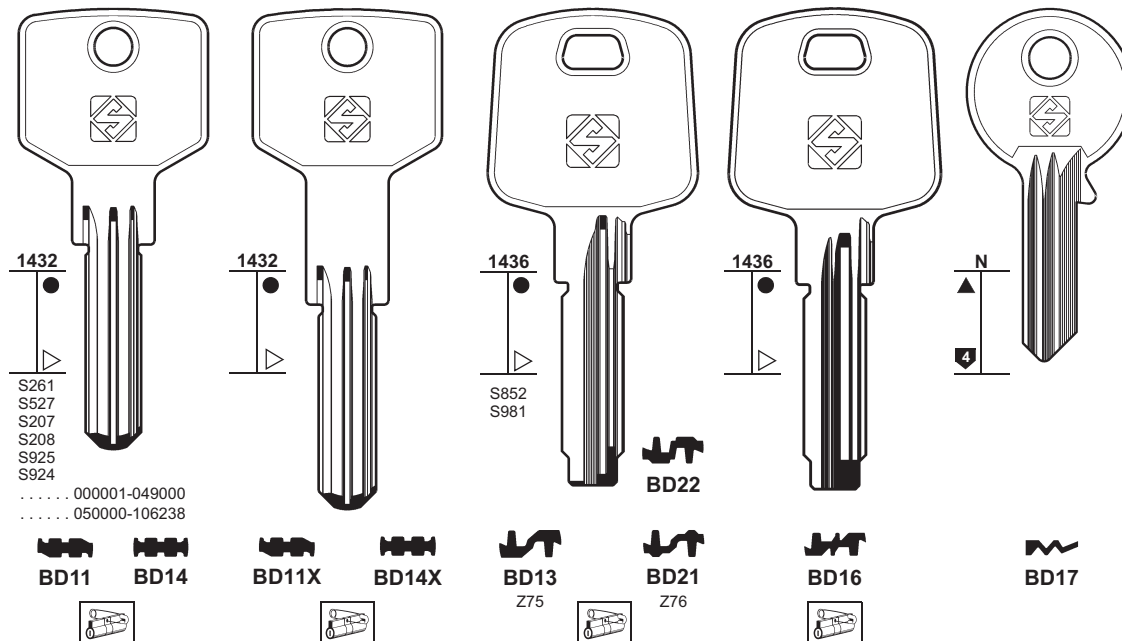



36

PER / FOR

**BRUMME** (D)

FANA

FTH

+ ZEISS-IKON (201)

**BSS** (SCG)

BANE SEKULIĆ

+ URBIS (180)

**BTV** (E)

AGA (10)

DOM (61)

STS (162)

**BUFFO** (GR)

ABUS (7-9)

**BUG** (D)

CORONA (55)

**BUGA** (F)

BASI

CITY

IFAM

**BULAT** (PRC)

**BULLDOG** (GB)

**BULLOCK** (I)

ZADI (200)

**BURAM** (YU)

PER: **BRUMME**

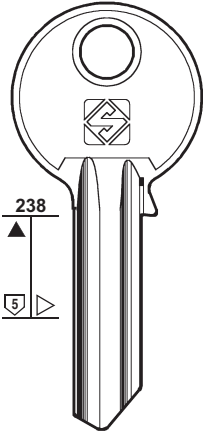

238  
▲  
5



**BRM1** **BRM1R**

FANA - FTH

**BSS**

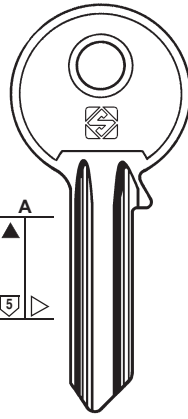

A  
▲  
5



**BS1**

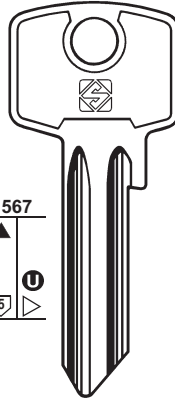

567  
▲  
5



**BS2**



▲ **BS7**

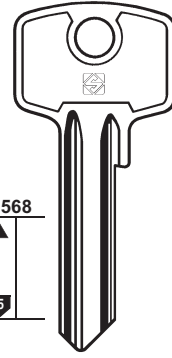

568  
▲  
5



**BS3**

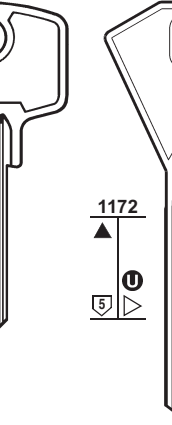

1172  
▲  
5



▲ **BS5**



**BS5R**

BANE SEKULIĆ

PER: **BSS**

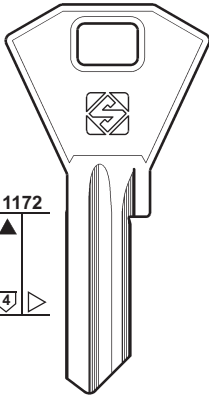

1172  
▲  
4



**BS6R**

**BUGA**

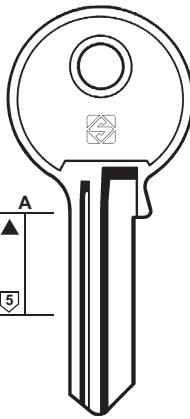

A  
▲  
5



**CS33**



**CS33R**

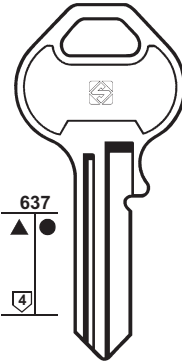

637  
▲  
4



▲ **CS32**



**CS32R**

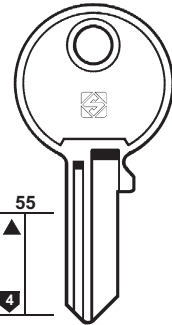

55  
▲  
4



**CS26**



**CS26R**

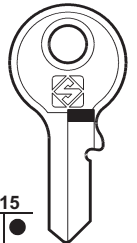

215  
▲  
3



**CS23**



**CS23R**

**BASI**



mm 50-60

**BASI - CITY**



mm 40

**CITY**



mm 30

**BASI - IFAM**



mm 20

PER: **BULAT**

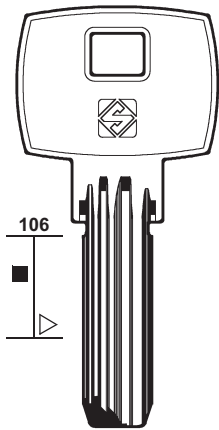

106  
■  
▶



**BUT1R**



**BULLDOG**

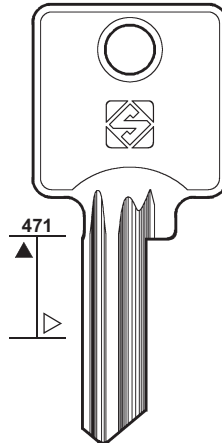

471  
▲  
▶



**BLG1**

**BURAM**

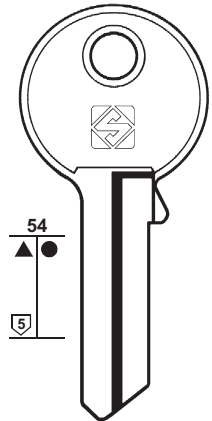

54  
▲  
5



▲ **BU1**



**BU1R**

PER:  
FOR:

# BURG

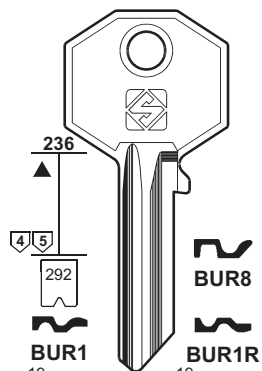

- |     |               |
|-----|---------------|
| 19  | 19            |
| 20  | 20            |
| 21  | 22            |
| 23  | 24            |
| 27  | 28            |
| 29  | 30            |
| 31  | 32            |
| 33  | 34            |
| 49  | 799           |
| 769 | 0-1-2-3-4-5-6 |
| 799 |               |

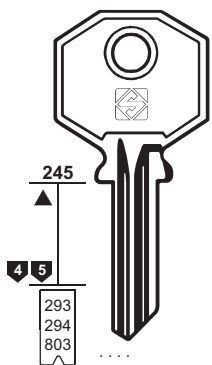

- |    |               |
|----|---------------|
| 11 | 116/30        |
| 12 |               |
| 13 |               |
| 14 | 0-1-2-3-4-5-6 |
| 15 |               |
| 16 | 0-1-2-3-4-5-6 |
| 17 |               |
| 18 |               |
| 19 |               |
| 20 |               |
| 21 |               |
| 22 |               |
| 23 |               |
| 24 |               |
| 25 |               |
| 26 |               |
| 27 |               |
| 28 |               |
| 29 |               |
| 30 |               |
| 31 |               |
| 32 |               |
| 33 |               |
| 34 |               |
| 35 |               |
| 36 |               |
| 37 |               |
| 38 |               |
| 39 |               |
| 40 |               |
| 41 |               |
| 42 |               |
| 43 |               |
| 44 |               |
| 45 |               |
| 46 |               |
| 47 |               |
| 48 |               |
| 49 |               |
| 50 |               |
| 51 |               |
| 52 |               |



## BUR2

- |    |     |
|----|-----|
| 11 | 239 |
| 12 | 319 |
| 13 | 339 |
| 14 | 359 |
| 15 | 379 |
| 16 | 239 |
| 17 | 389 |
| 18 | 399 |
| 19 | 399 |
| 20 | 409 |
| 21 | 429 |
| 22 | 429 |
| 23 | 449 |
| 24 | 509 |
| 25 | 529 |
| 26 | 549 |
| 27 | 549 |
| 28 | 569 |
| 29 | 589 |
| 30 | 608 |
| 31 | 608 |
| 32 | 609 |
| 33 | 629 |
| 34 | 649 |
| 35 | 659 |
| 36 | 689 |
| 37 | 709 |
| 38 | 729 |
| 39 | 749 |
| 40 | 789 |
| 41 | 809 |
| 42 | 819 |
| 43 | 829 |

## BUR2R

- |    |  |
|----|--|
| 11 |  |
| 12 |  |
| 13 |  |
| 14 |  |
| 15 |  |
| 16 |  |
| 17 |  |
| 18 |  |
| 19 |  |
| 20 |  |
| 21 |  |
| 22 |  |
| 23 |  |
| 24 |  |
| 25 |  |
| 26 |  |
| 27 |  |
| 28 |  |
| 29 |  |
| 30 |  |
| 31 |  |
| 32 |  |
| 33 |  |
| 34 |  |
| 35 |  |
| 36 |  |
| 37 |  |
| 38 |  |
| 39 |  |
| 40 |  |
| 41 |  |
| 42 |  |
| 43 |  |
| 44 |  |
| 45 |  |
| 46 |  |
| 47 |  |
| 48 |  |
| 49 |  |
| 50 |  |
| 51 |  |
| 52 |  |

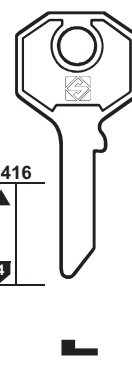
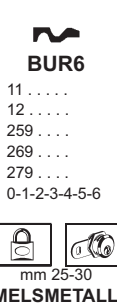
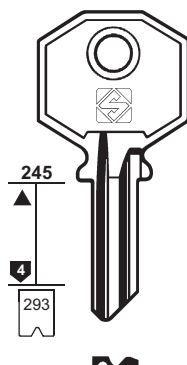

# 37

PER / FOR

- BURG (D)**  
**MELSMETALL**  
+ ABUS (8)  
+ HOPPE (93)  
+ MELSMETALL (122)  
+ OJMAR (134)  
+ RONIS (147)  
+ VIRO (187)  
+ ZEISS-IKON (201)

PER:  
FOR:

# BURG

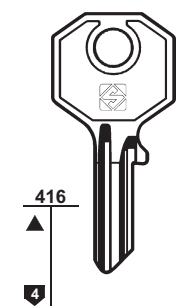

BUR11  
BUR4

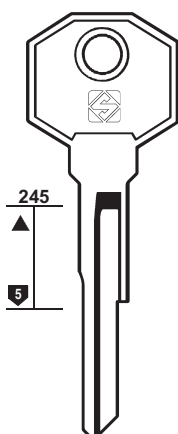

BUR5

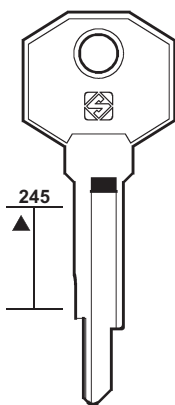

BUR12

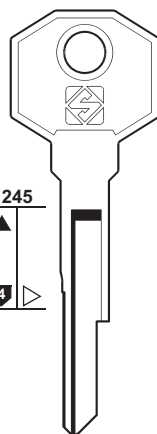

BUR19

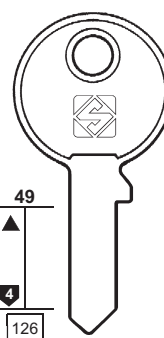

BUR3 BUR3R  
BUR10R



M... 601-983

PER:  
FOR:

# BURG

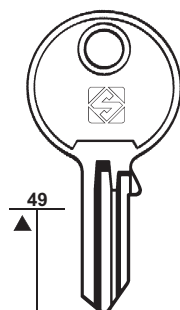

BUR9

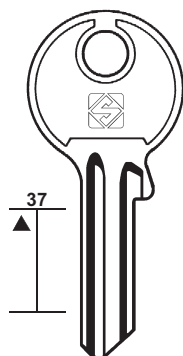

BUR15

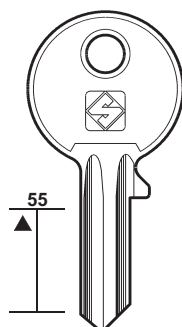

BUR16

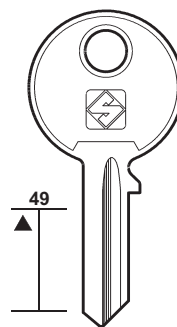

BUR17R



38

PER / FOR

BURG (D)  
HOPPE  
OTTO

- + ABUS (8)
- + HOPPE (93)
- + MELSMETALL (122)
- + OJMAR (134)
- + RONIS (147)
- + VIRO (187)
- + ZEISS-IKON (201)

PER:  
FOR:

BURG

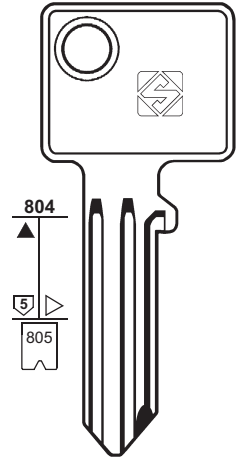
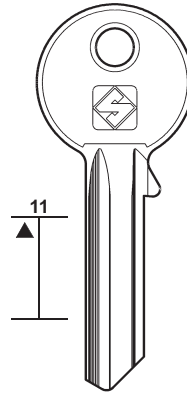
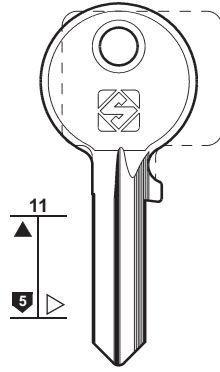
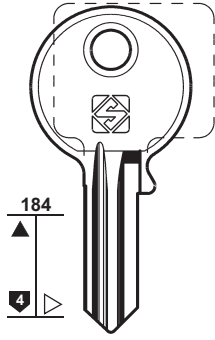

BUR22



BUR22R



mm 30-35



● BUR23



BUR23R



mm 40



BUR29  
39R/68R



BUR18



BUR13

- ..... (600/40) 123456
- ..... (600/50) 123456
- ..... (600/60) 123456

PER:  
FOR:

BURG

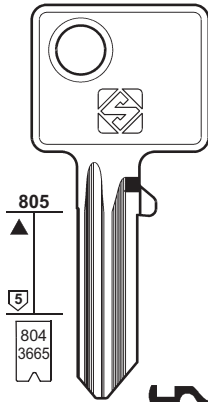

BUR14R

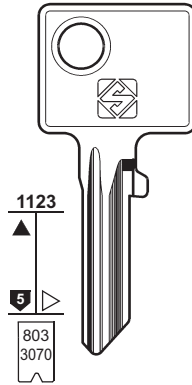

BUR20

BUR20R

- ..... (116/30)
- ..... (116/50)
- ..... (116/60)
- ..... 1-2-3-4-5
- ..... 1-2-3-4-5-6

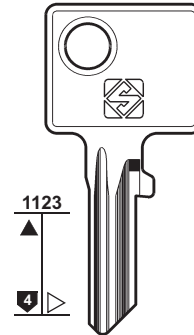

BUR26

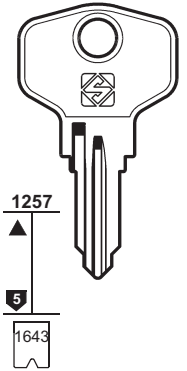

BUR24R

2W ... 1-246

HOPPE - OTTO

PER:  
FOR:

BURG

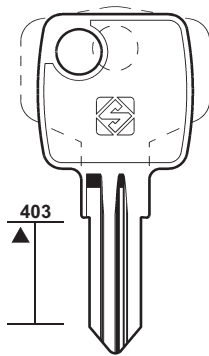

BUR28R

34W

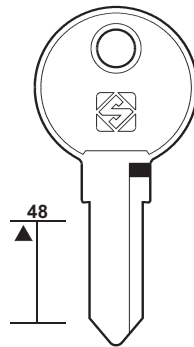

BUR31

BUR31R

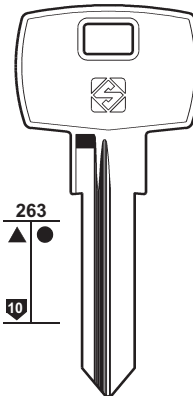

● BUR32

26W

BUR34R

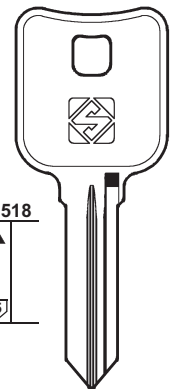

BUR38



PER:  
FOR:

# BURG

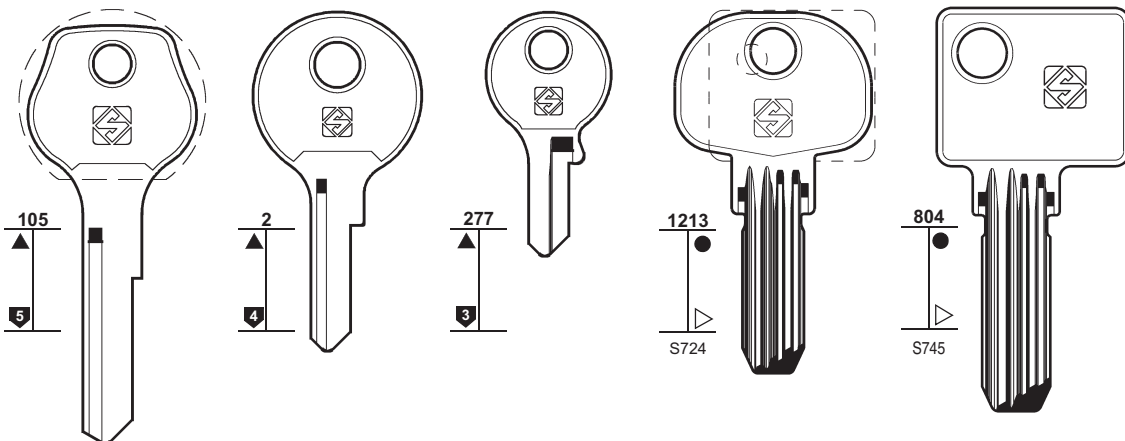

**BUR57R**  
71R

**BUR55R**  
77R

**BUR56**  
405/20

**BUR27**  
75W

**BUR33**  
76W



# 39

PER / FOR

## BURG (D)

- + ABUS (8)
- + HOPPE (93)
- + MELSMETALL (122)
- + OJMAR (134)
- + RONIS (147)
- + VIRO (187)
- + ZEISS-IKON (201)

## BUS (D) KROST

## BUVA (D) GERA KALE

## BV (D)

- + CAS-CISMA (40)
- + FASEM (77)

## BWS (GB)

- + CORBIN (53)

## CAB (I)

- + CAS-CISMA (40)
- + SIMECA (155)
- + YALE (194)

## CAF (I)

## CAM (F)

- + ISEO (97)

PER:  
FOR:

# BUS

# BUVA

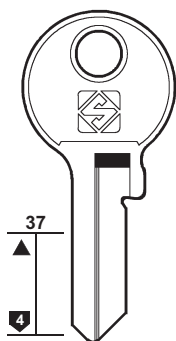

**BUS1**

KROST

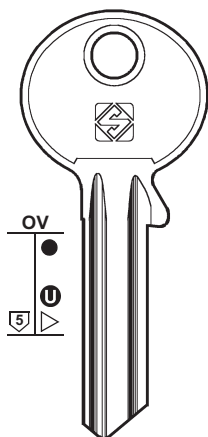

**BVA1** ▲ **BVA1R**

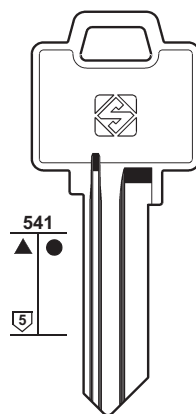

**BVA3**

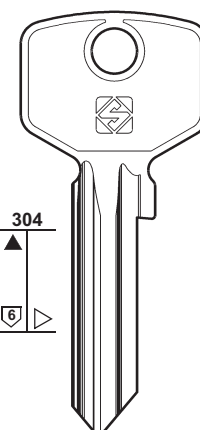

**BVA4**

GERA - KALE

PER:  
FOR:

# CAB

# CAF

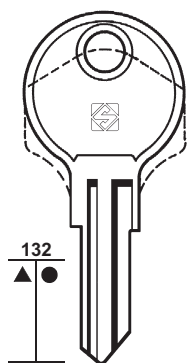

**CAB1**

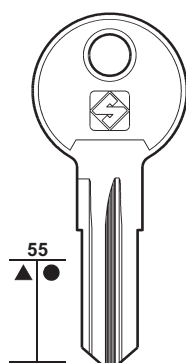

**CAB2R**

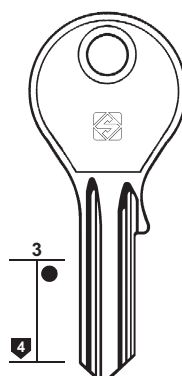

**CAF1** **CAF1R**

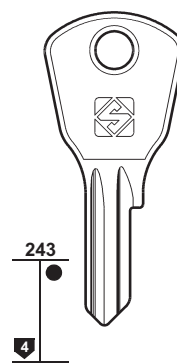

**CAF2** **CAF2R**



40

PER / FOR

**CANDA VEN CV** (V)

**CAP** (F)

- 👁 CITY (51)
- 👁 KRV (105)
- 👁 PREFER (142)
- 👁 VACHETTE (184)

**CARACAL** (RC)

**CARAT**

- 👁 YALE (194)

**CAROLI** (I)

- 👁 MERONI (193)

**C.A.R.S.** (I)

- 👁 OMA (135)

**CASAS** (E)

- 👁 AGA (11)

**CAS-CISMA** (I)

- BV
- CAB
- DOMUS
- ETNA
- FTH
- GSA
- GUARDIAN
- LAPERCHÉ
- M
- MST
- SISO
- STIQAM
- STREMLER
- TECHNAL
- TESTA

**CASI** (D)

- 👁 SCHLECHTENDAHL (152)

**CASIO** (I)

- 👁 OLIVETTI (134)

**CASH-BOX** (D)

- + 👁 CLAUSOR (51)
- + 👁 KIFERM (106)

**CASMA** (I)

- 👁 CES (43)
- 👁 P.C. (140)

**CATOR** (F)

- 👁 RONIS (146-147)

**CAVERS** (F)

- 👁 AZBE (24)
- 👁 CISA (48)
- 👁 CITY (51)
- 👁 SPIDER (159)

**CAYS** (E)

PER:  
FOR:

### CANDA VEN CV

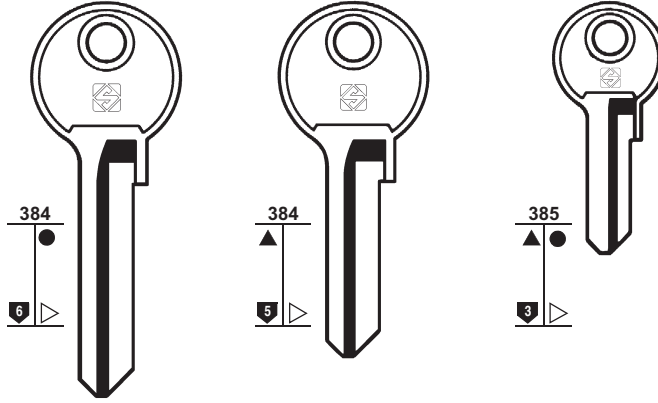

CV1

CV2

CV3



### CARACAL

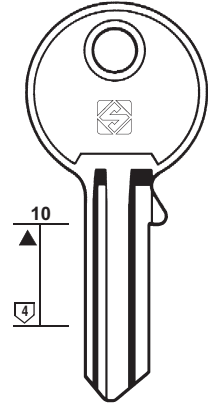

CAR1



PER:  
FOR:

### CAS-CISMA

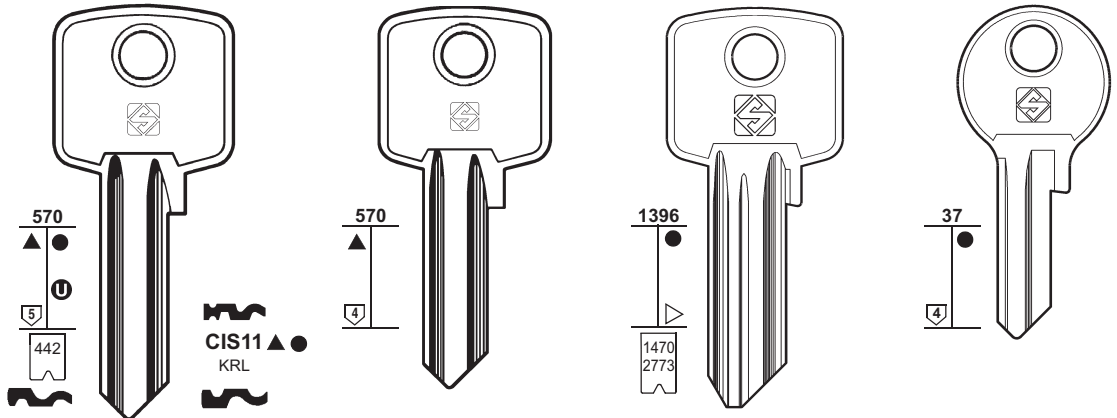

CIS5

- ..... 1234567
- ..... 123456789AB
- L ..... 1001-2178
- L ..... 14001-14500
- L ..... 15001-18199
- ..... 20001-20625

CIS11 ▲ ●  
KRL

CIS5R ●

CIS8 ●

CIS6 ● CIS6R

CIS9  
..... 12345678AB

CIS12  
..... 12345678

CIS7

ETNA - FTH - GSA - LAPERCHÉ  
STREMLER - TECHNAL

ETNA - GSA  
LAPERCHÉ - STREMLER



PER:  
FOR:

### CAS-CISMA

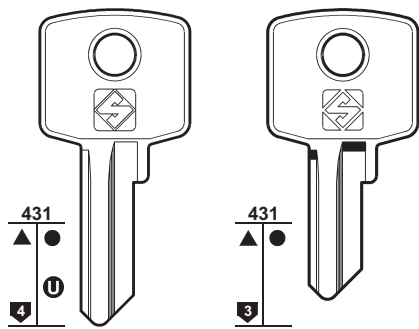

CIS2

CIS4 ▲ ● CIS4R ●

CIS1 CIS3



BV - CAB - DOMUS - GUARDIAN  
M - MST - SISO - STIQAM - TESTA

### CASH-BOX

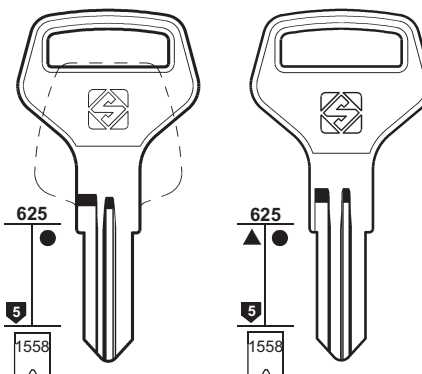

..... 101-170  
..... 201-270

CAX1R



..... 0-1-2  
..... 301-370

CAX2R



### CAYS

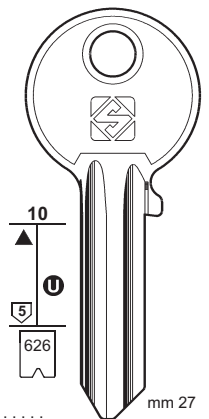

..... mm 27  
0-1-2-3-4-5-6-7-8-9

⊕ CYS1 CYS1R ▲



PER: FOR:	CAYS	CCC	CEE	CEMA
				ELFIN - LAMPA

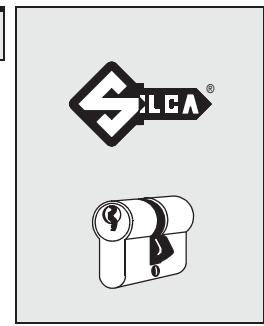

# 41

- PER / FOR
- CAYS (E)
  - CCC (IL)
  - CEE (P)
  - CCL (F)
    - CORBIN (55)
  - CEKA (D)
    - HUWIL (94)
  - CEMA (I)
    - ELFIN
    - LAMPA
  - CENTURY (GB)
    - ALLGOOD
  - CES (D)
    - BODA
    - ELZETT
    - FRECOV
    - HÄFELE
    - HANNO
    - JOSTA
    - KARDEX
    - KIND
    - KNAPP
    - MAUSER
    - NEMEF
    - OJMAR
    - SÄNTIS
    - STUV
    - VOKO
    - WASO
    - WECO

PER:  
FOR:

## CENTURY

				ALLGOOD

PER:  
FOR:

## CES

ELZETT FRECOV HÄFELE HANNO JOSTA KARDEX KIND KNAPP MAUSER NEMEF OJMAR VOKO WASO WECO	BODA ELZETT FRECOV KNAPP	ELZETT FRECOV HÄFELE HANNO JOSTA KARDEX KIND KNAPP MAUSER NEMEF OJMAR SÄNTIS VOKO WASO WECO	BODA ELZETT FRECOV KNAPP	12345678 CE34 123456789 CE35 123456789 CE36 123456789	12345678 CE10 WS... 401-410 CE21R WS... 401-410 CE29R	FRECOV HÄFELE HANNO JOSTA KARDEX KIND KNAPP MAUSER NEMEF OJMAR VOKO WASO WECO	BODA FRECOV KNAPP OJMAR	N... 1-50 ... 101-400	STUV



# 42

### PER / FOR

**CES (D)**  
 BERRY  
 BODA  
 BOTT  
 COMBA  
 ELZETT  
 FEFI  
 FRECOV  
 FUHR  
 GIESCHE  
 HÄFELE  
 HANNO  
 HÖHRMANN  
 JOSTA  
 KARDEX  
 KIMA  
 KIND  
 KNAPP  
 MAUSER  
 MBB  
 NEMEF  
 OJMAR  
 OTIS  
 SÄNTIS  
 SIEBAU  
 SOLID  
 SS  
 STUV  
 TORE  
 TRITON  
 VOKO  
 WASO  
 WECCO

PER:  
FOR:

## CES

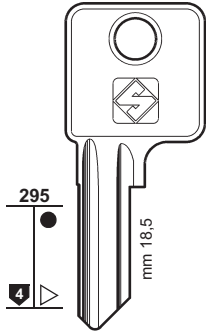

**CE33**

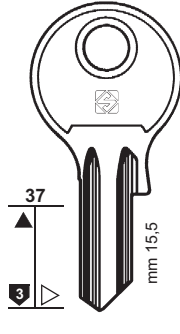

**CE13**  
 ELZETT  
 FRECOV  
 HÄFELE  
 HANNO  
 JOSTA  
 KARDEX  
 KIND  
 KNAPP  
 MAUSER  
 NEMEF  
 OJMAR  
 VOKO  
 WASO

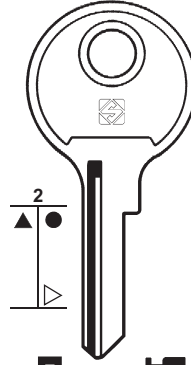

**CE11**    ▲ **CE11R**  
 BOTT

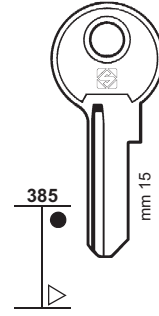

**CE19**  
 CE19R

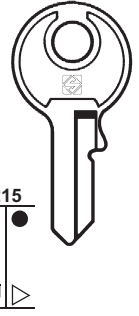

**CE30**  
 CE30R

PER:  
FOR:

## CES

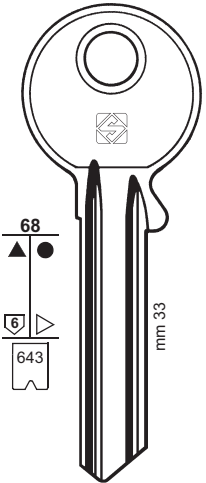

**CE3**    **CE3R**  
 .....  
 1-2-3-4-5-6-7-8-9-0  
 BODA

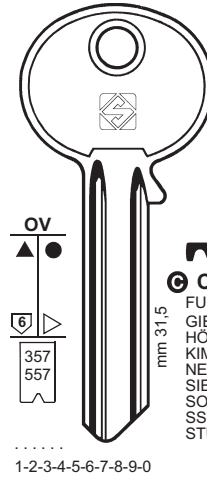

**CE1**  
 FUHR  
 GIESCHE  
 HÖHRMANN  
 KIMA  
 NEMEF  
 SIEBAU  
 SOLID  
 SS  
 STUV

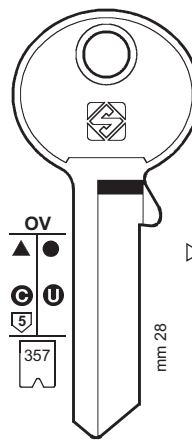

**CE5**

.....  
 1-2-3-4-5-6-7-8-9-0  
 BB ..... 1-12000  
 BBF ..... 1-12000  
 BT ..... 1-12000  
 TS ..... 1-12000

**CE2**  
 BERRY  
 COMBA  
 FEFI  
 HÄFELE  
 HÖHRMANN  
 MBB  
 NEMEF  
 OTIS  
 SÄNTIS  
 SOLID  
 STUV  
 TORE  
 TRITON

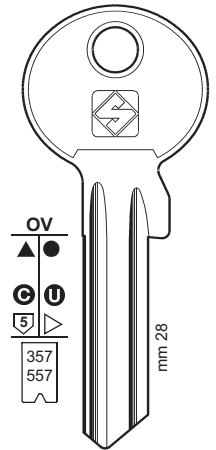

**CE2X**

PER:  
FOR:

## CES

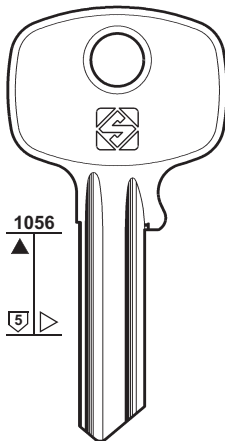

**CE40**

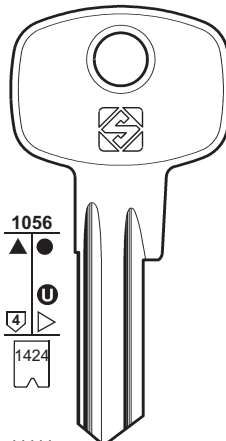

**CE41**

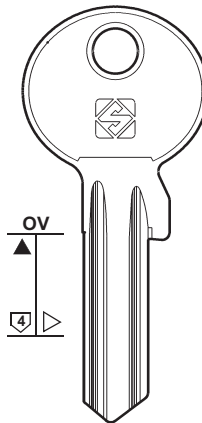

**CE41X-OV**

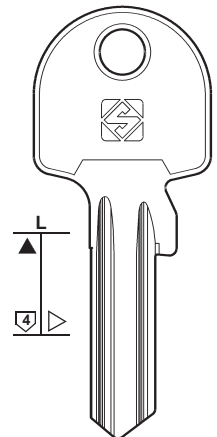

**CE41XL**

HÄFELE

PER:  
FOR:

### CES

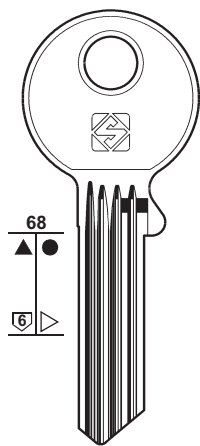

CE17XPS

CE17WPS

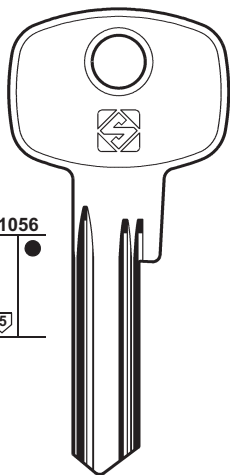

CE127  
NEMEF

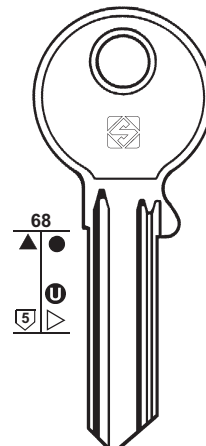

CE20

CE114  
NEMEF



# 43

PER / FOR

**CES (D)**  
BODA  
CASMA  
NEMEF  
SPEEDAL

PER:  
FOR:

### CES

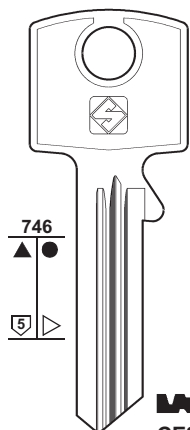

CE23R

CE28

CE31

CE24R

CE32R

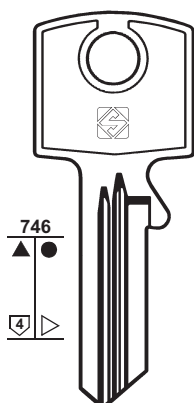

CE25R

CE27

CE26R

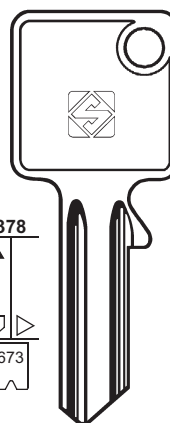

CE12  
..... 1234567890

CASMA - SPEEDAL

PER:  
FOR:

### CES

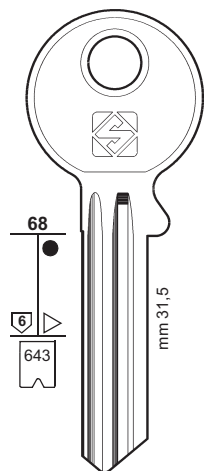

K CE15 CE39

TB CE16

15 CE14-15

16 CE14-16

17 CE14-17

18 CE14-18

25 CE14-25  
..... 1234567890

26 CE14-26

27 CE14-27

28 CE14-28

35 CE14-35

36 CE14-36

37 CE14-37

38 CE14-38

45 CE14-45

46 CE14-46

47 CE14-47

48 CE14-48

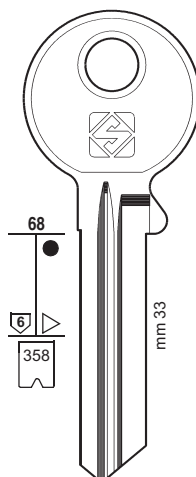

15 CE22-15

16 CE22-16  
12..... 1-100000

17 CE22-17

18 CE22-18

25 CE22-25

26 CE22-26

27 CE22-27

28 CE22-28

35 CE22-35

36 CE22-36

37 CE22-37

38 CE22-38

45 CE22-45

46 CE22-46

47 CE22-47

48 CE22-48

BODA

BODA



44

PER / FOR

CES (D)  
BODA  
THÖMEE

PER:  
FOR:

CES

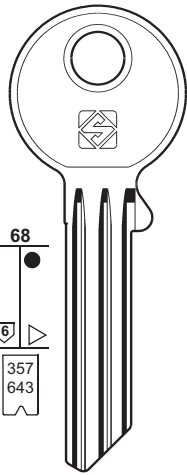

.....  
1-2-3-4-5-6-7-8-9-0

CE130-1 C/2	CE130-2 B/2	CE130-3 B/1	CE130-4 C/4	CE130-5 A/4	CE130-6 A/5	CE130-7 C/5
CE130-8 C/1	CE130-9 A/2	CE130-10 D/1	CE130-11 A/34	CE130-12 B/3	CE130-13 X/678	CE130-14 1/68
CE130-15 4/67	CE130-16 4/68	CE130-17 AB5	CE130-18 B1/5	CE130-19 C1/5	CE130-20 AD1	CE130-21 AD4
CE130-22 A1-5	CE130-23 AB1-3	CE130-24 D1-5	CE130-25 D/2	CE130-26 D/5	CE130-27 D/4	CE130-28 A/3
CE130-29 C/34	CE130-30 C/3	CE130-31 B/34	CE130-32 B/5	CE130-33 B/4	CE130-34 D/3	CE130-35 A/1

BODA - THÖMEE

PER:  
FOR:



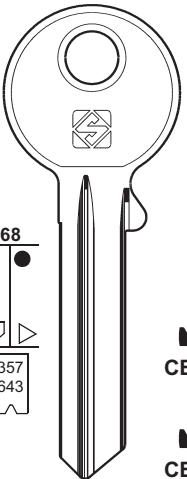





CES

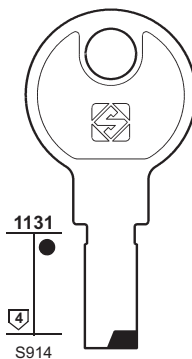

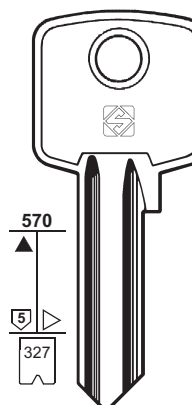
.....  
1-2-3-4-5-6-7-8-9-0

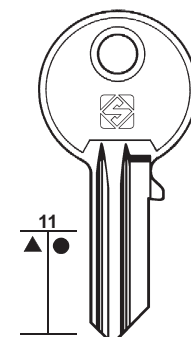

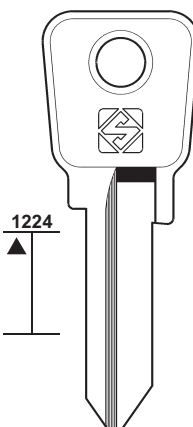



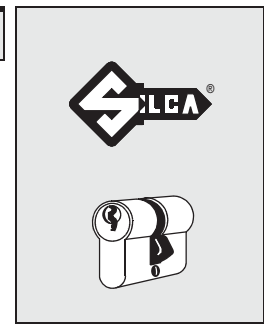



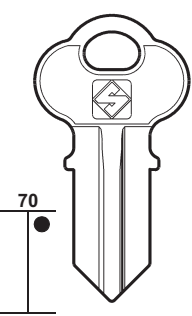

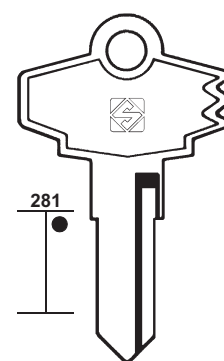

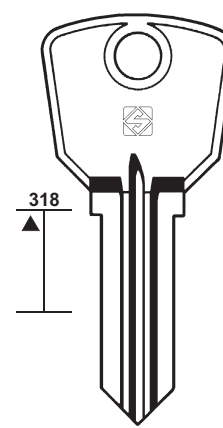

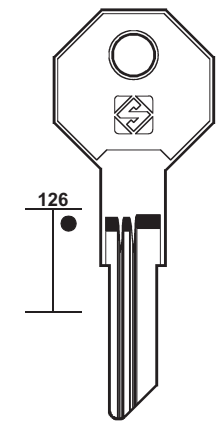
CE129-1 R/8	CE129-2 Z/568	CE129-3 1/678	CE129-4 2/568	CE129-5 R/7	CE129-6 Z/68	CE129-7 G/56	
CE129-8 G/68	CE129-9 R/R	CE129-10 G/5	CE129-11 G/6	CE129-12 3/567	CE129-13 G/67	CE129-14 3/R	
CE129-15 3/568	CE129-16 Y/567	CE129-17 G/57	CE129-18 2/R	CE129-19 1/56	CE129-20 Y/68	CE129-21 1/67	
CE129-22 3/68	CE129-23 G/678	CE129-24 3/58	CE129-25 3/678	CE129-26 4/578	CE129-27 4/568	CE129-28 3/57	CE129-29 G/568
CE129-30 4/678	CE129-31 3/578	CE129-32 2/57	CE129-33 Z/67	CE129-34 G/578	CE129-35 1/567	CE129-36 1/G	CE129-37 4/58
CE129-38 X/R	CE129-39 4/78	CE129-40 1/568	CE129-41 G/8	CE129-42 G/7	CE129-43 X/6	CE129-44 4/56	CE129-45 Y/5
CE129-46 Z/7	CE129-47 2/56	CE129-48 G/58	CE129-49 2/67	CE129-50 2/68	CE129-51 4/567	CE129-52 4/G	CE129-53 1/78
CE129-54 X/G	CE129-55 3/78	CE129-56 Z/5	CE129-57 2/G	CE129-58 2/578	CE129-59 Z/G	CE129-60 Z/56	CE129-61 Y/78
CE129-62 X/58	CE129-63 Y/67	CE129-64 4/R	CE129-65 Y/56	CE129-66 Z/567	CE129-67 Y/G	CE129-68 Z/78	CE129-69 Y/7
CE129-70 2/58	CE129-71 X/7	CE129-72 1/58	CE129-73 4/57	CE129-74 X/67	CE129-75 Y/6	CE129-76 3/56	CE129-77 G/G
CE129-78 Y/57	CE129-79 Y/8	CE129-80 Z/8	CE129-81 2/567	CE129-82 X/8	CE129-83 Y/58	CE129-84 3/67	CE129-85 2/78
CE129-86 Z/6	CE129-87 3/G	CE129-88 2/678	CE129-89 X/5	CE129-90 R/6			

BODA - THÖMEE











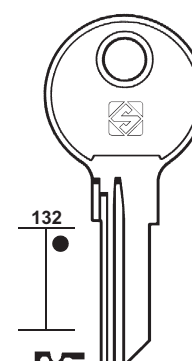

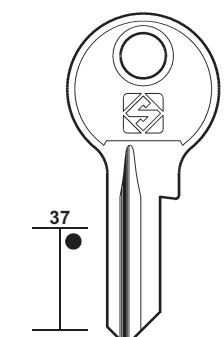

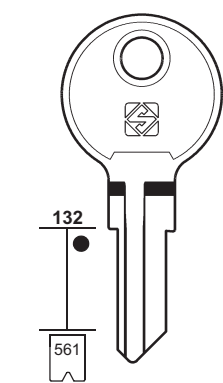

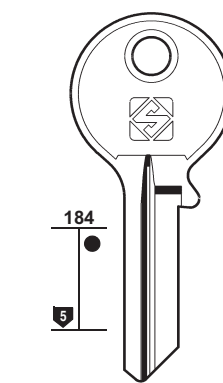

PER: FOR:	CES	CHAVO	CHEK	CHELIABINSK
	 <p>1131 S914</p> <p>MS . . . 1-20</p> <p><b>CE131</b></p> 	 <p>570 327</p> <p><b>CHV1 CHV1R</b></p>  	 <p>11</p> <p><b>CK1</b></p>  <p><b>CHEYLOCK</b></p> 	 <p>1224</p> <p><b>CLK1</b></p> 



**45**

PER: FOR:	CHICAGO			
	 <p>70</p> <p><b>CH1</b></p> 	 <p>281</p> <p><b>CH2</b></p> 	 <p>318</p> <p><b>CH3</b></p> 	 <p>126</p> <p><b>CH4</b></p> 
	<p><b>CH5</b></p> 	<p><b>CH6</b></p> 	<p><b>CH7</b></p> 	<p><b>CH7R</b></p> 
	<p><b>CH8</b></p> 	<p><b>CH15</b></p> 	<p><b>ILLINOIS - ODA</b></p> 	
	<p><b>FORT</b></p> 		<p><b>STEELCASE</b></p> 	

PER / FOR
<b>CES</b> (D)
<b>CEV</b> (I) IDRO-STOP (94)
<b>CF</b> (F) FTH (81)
<b>CFP</b> (D) WILKA (191)
<b>CHANGE-O-MATIC</b> (F) CORBIN (55)
<b>CHAVO</b> (P) + CISA (48) + SOFI-SONAFI (157)
<b>CHEK</b> (HK) CHEYLOCK
<b>CHELIABINSK</b> (RUS)
<b>CHEYLOCK</b> (HK) CHEK (45)
<b>CHG</b> (F) GABON (84)
<b>CHICAGO</b> (USA) FORT ILLINOIS ODA STEELCASE

PER: FOR:	CHICAGO			
	 <p>132</p> <p><b>CH18</b></p> 	 <p>37</p> <p><b>CH11</b></p> 	 <p>132</p> <p>561</p> <p><b>CH19</b></p> 	 <p>184</p> <p>5</p> <p><b>CH27</b></p> 
	<p><b>CH12</b></p> 	<p><b>CH10</b></p> 	<p><b>CH24R</b></p> 	<p><b>YA18</b></p> 
	<p><b>CH13</b></p> 	<p><b>CH14</b></p> 	<p>LL . . . 1-225</p>	<p>FL . . . 201-240 UM . . . 226-425 LL . . . 226-450 . . . 500-550 . . . 600-650</p>
	<p><b>FR</b></p> 	<p><b>XF</b></p> 	<p><b>FR</b></p> 	<p><b>FR</b></p> 
	<p><b>STEELCASE</b></p>			



# 46

### PER / FOR

#### CHICAGO (USA)

ACE  
 ADEMCO  
 AGA  
 ALPHA  
 EURO LOCKS  
 FORT  
 GEM  
 IFAM  
 L & F

#### CHRIST (D)

DOM (60)  
 HUWIL (94)

#### CHSS (RC)

#### CHUBB (GB)

+ AVA-CHUBB (24)

#### CIAL (BR)

#### CIB (F)

FTH (81)  
 OMIV (136)  
 PREFER (142)  
 UCEM (175)

#### CIBC (I)

CISA (50)  
 FTH (82)

#### CIC (I)

BASI (28)  
 CORNI (55)

#### CIEF (F)

#### CIELS (I)

PER:  
FOR:

## CHICAGO

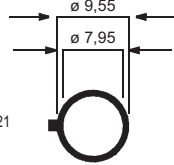
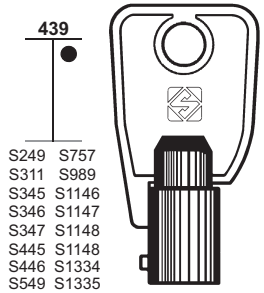

CH9T

... 1-999  
 .... 2001-2100  
 ..... 0123  
 ..... 7654321  
 ..... 7654321  
 ..... 7654321  
 ..... 1234567  
 ..... 280001-285000  
 ..... 320001-326000  
 ..... 24568ABCDEFGHIJKLMNO  
 ..... HD 0001-9400  
 ..... HD 0001-9400  
 ..... HMC 00001-31000  
**ACE - ADEMCO - AGA - ALPHA**  
**EURO LOCKS - FORT**  
**GEM - IFAM - L & F**

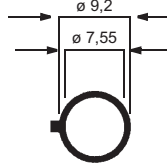
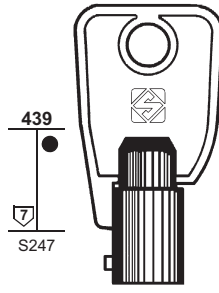

CH16T

..... 7-6-5-4-3-2-1

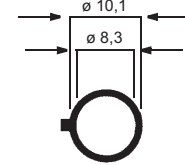
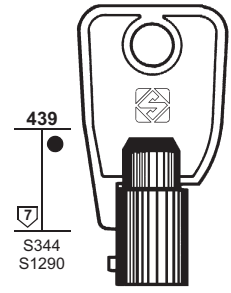

CH17T

..... 123456  
 ..... X123456

PER:  
FOR:

## CHSS

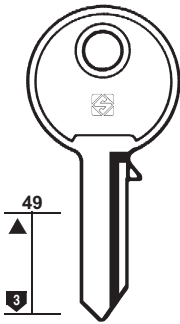

CHS1



mm 30

## CHUBB

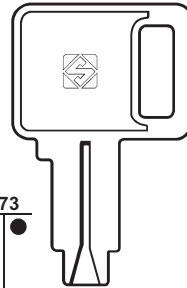

CHU5



1-2-3-4-5

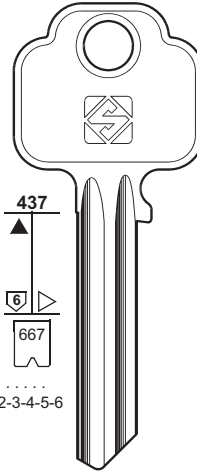

CHU6

1-2-3-4-5-6

## CIAL

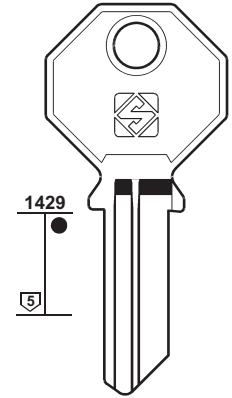

CIA1

PER:  
FOR:

## CIEF

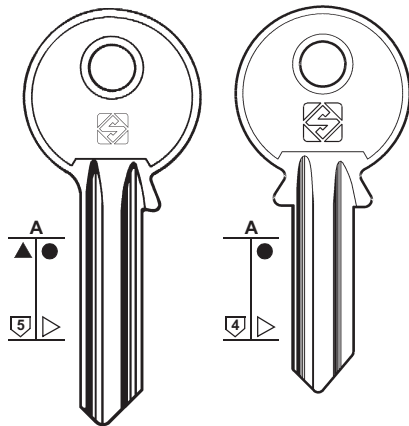

FEB2 ● FEB2R    FEB1    FEB1R

## CIELS

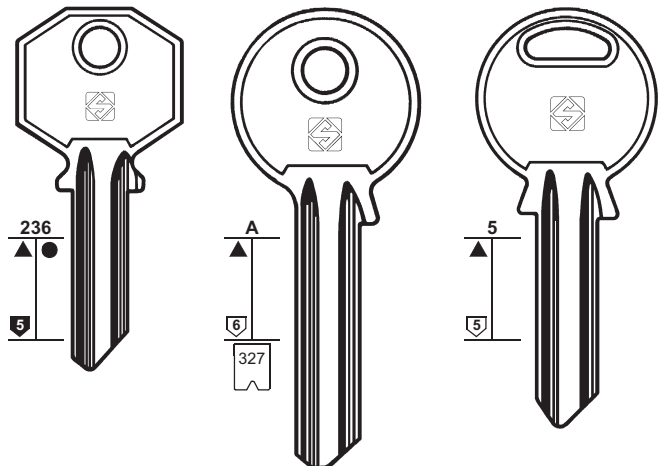

CLS1    CLS242 ● CLS3    ● CLS220    CLS2

1-2-3-4-5-6

PER: **CIERRA SOLA**  
FOR:

**CIFIAL**

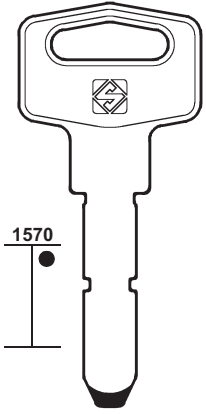

**CRL1**

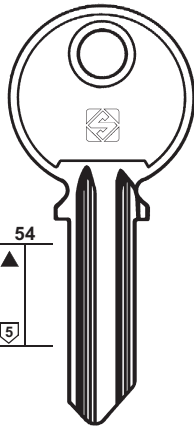

**CF1**

**CF1R**

**CF2**

**CF2R**

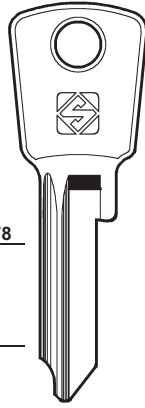

**CF3**

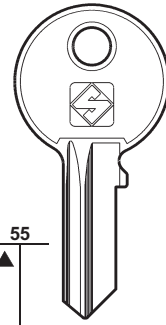

**CF4**

LE FEBURE



**47**

PER / FOR

**CIERRA SOLA (RA)**

**CIFIAL (P)**  
LE FEBURE

**CIGNO (I)**  
CISA (50)

**CILA-GENTILI (I)**

**CINA (RC)**  
SHANGHAI  
+ SHANGHAI (153)

PER:  
FOR:

**CILA-GENTILI**

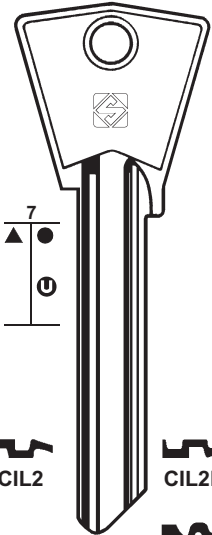

**CIL2**

**CIL2R**

**CIL6**

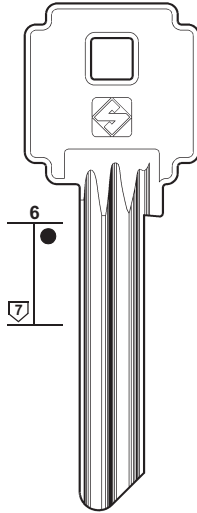

**CIL7**

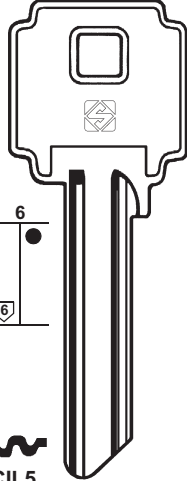

**CIL5**

**CIL1**

**CIL1R**

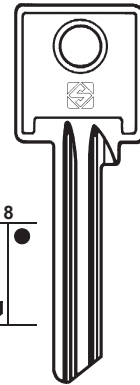

**CIL3**



PER:  
FOR:

**CINA**

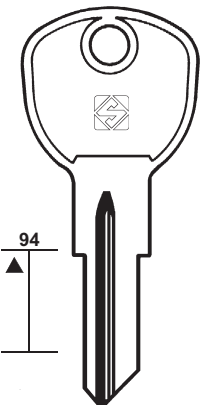

**RC1R**

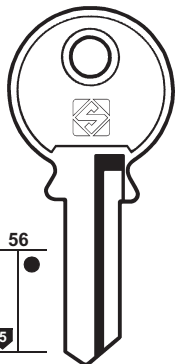

**A303**

**C303**

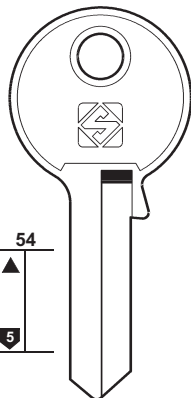

**AS1**



mm 45

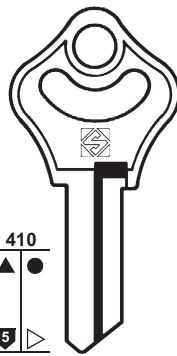

**SG808**

**SG808R**



SHANGHAI

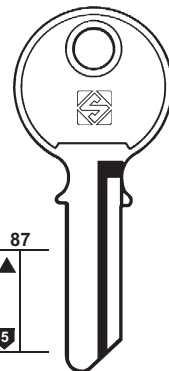

**SG1**



SHANGHAI



48

PER / FOR

CINA (RC)

555  
ALI  
EIKO  
+ SHANGHAI(153)

CISA (I)

ABUS  
ALA  
ALF  
BRICARD  
CAVERS  
CHAVO  
DOBUS  
ESCO  
ESSENDIA  
GEFI  
GETE  
GEVY  
GTV  
ITO  
LOGO  
NB  
SCHÜCO  
STANDARD  
TIEFENTHAL  
TZAFRER  
UNIFERRO  
+ ABUS (6-7-8-10)  
+ ALA (13)

PER:  
FOR:

CINA

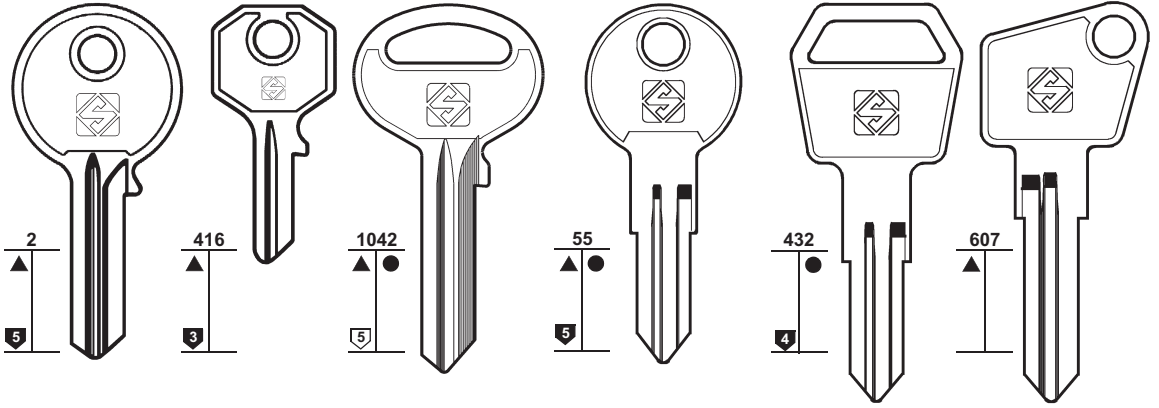

454



C555



555



RC3R ▲ RC4

ALI - EIKO



RC5



● RC5R



RC6



RC6R



RC7R



PER:  
FOR:

CISA

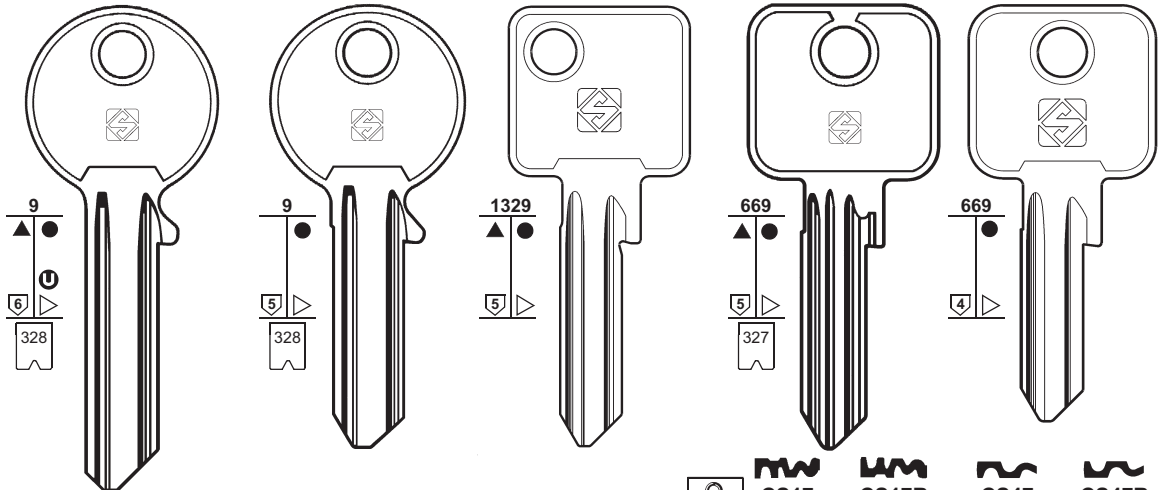

● CS501R



mm 70



CS501

..... 1-2-3-4-5



CS500R



CS500

..... 1-2-3-4-5



CS85

ABUS



CS17

mm 50-55-60-65  
70-75-77-84-94



mm 50-60



CS17R

..... 1-2-3-4-5-6

ALA



mm 50-60



CS47



mm 50-60



CS47R



mm 50-60

PER:  
FOR:

CISA

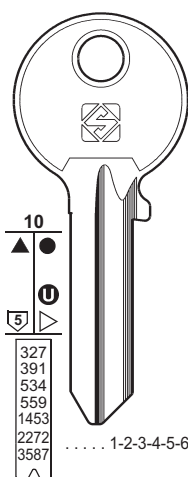

..... 1-2-3-4-5-6



mm 50-60

AY ..... 1-6032  
BA ..... 1-6032  
BB ..... 1-6032  
BC ..... 1-6032  
BD ..... 1-6032  
BJ ..... 1-6032  
BK ..... 1-6032  
BL ..... 1-6032  
BM ..... 1-6032  
BN ..... 1-6032  
BP ..... 1-6032  
BQ ..... 1-6032  
BR ..... 1-6032  
BS ..... 1-6032  
BT ..... 1-6032  
BU ..... 1-6032  
BY ..... 1-6032  
SA ..... 1-6032  
SB ..... 1-6032  
..... 123456  
..... 123456789

CS206  
ABUS  
ALF  
CHAVO  
ESCO  
ESSENDIA  
GEFI  
GETE  
GTV  
ITO  
NB  
SCHÜCO  
STANDARD  
TIEFENTHAL  
UNIFERRO  
P.....  
00000-02360  
E..... 1234567890ABCDEFGHI  
G28D



CS13

BRICARD



CS14

BRICARD



CS24

LOGO

LOGO

LOGO

LOGO

LOGO

LOGO

LOGO

LOGO

LOGO

LOGO

LOGO

LOGO

LOGO



CS13R

BRICARD



CS14R

BRICARD



CS18

LOGO

LOGO

LOGO

LOGO

LOGO

LOGO

LOGO

LOGO

LOGO

LOGO

LOGO

LOGO

LOGO



CS15

BRICARD



CS15R

BRICARD



CS18R

LOGO

LOGO

LOGO

LOGO

LOGO

LOGO

LOGO

LOGO

LOGO

LOGO

LOGO

LOGO

LOGO

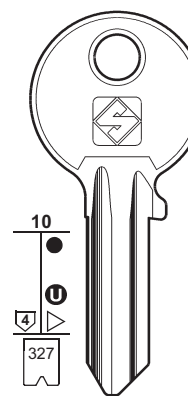

..... 1-2-3-4-5-6



mm 50-60



..... 1-2-3-4-5-6



mm 50-60



CS16

LOGO

LOGO

LOGO

LOGO

LOGO

LOGO

LOGO

LOGO

LOGO

LOGO

LOGO

LOGO

LOGO

LOGO

LOGO

LOGO

LOGO

LOGO

LOGO

LOGO

LOGO

LOGO

LOGO

LOGO

LOGO

LOGO

LOGO



CS16R

LOGO

LOGO

LOGO

LOGO

LOGO

LOGO

LOGO

LOGO

LOGO

LOGO

LOGO

LOGO

LOGO

LOGO

LOGO

LOGO

LOGO

LOGO

LOGO

LOGO

LOGO

LOGO

LOGO

LOGO

LOGO

LOGO

LOGO



CS16R

LOGO

LOGO

LOGO

LOGO

LOGO

LOGO

LOGO

LOGO

LOGO

LOGO

LOGO

LOGO

LOGO

LOGO

LOGO

LOGO

LOGO

LOGO

LOGO

LOGO

LOGO

LOGO

LOGO

LOGO

LOGO

LOGO

LOGO



PER:  
FOR:

# CISA

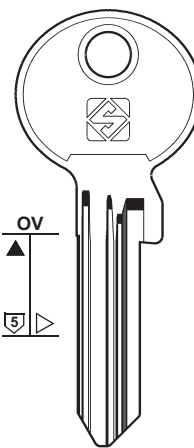
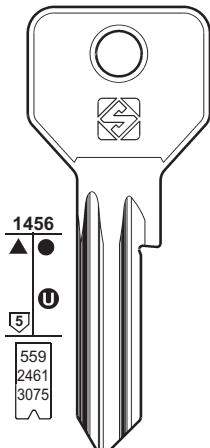
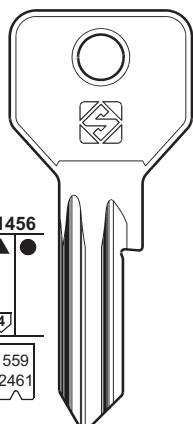
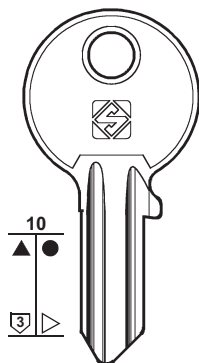

CS4 ●CS4R



CS120

..... 1-2-3-4-5-6-7-8  
..... (C 2000) 1-2-3-4-5-6-7-8



⊖ CS119 CS152 ●

..... 0-1-2-3-4-5-6-7-8 R027  
..... 1-2-3-4-5-6-7-8  
..... (C 2000) 1-2-3-4-5-6-7-8



CS13X CS52X ●

BRICARD G14D



●CS66



●CS120R



▲●CS119R



# 49

PER / FOR

CISA (I)

ABUS

BRICARD

ESLA

JPM

+ ● ABUS (6-7-8-10)

+ ● ALA (13)

PER:  
FOR:

# CISA

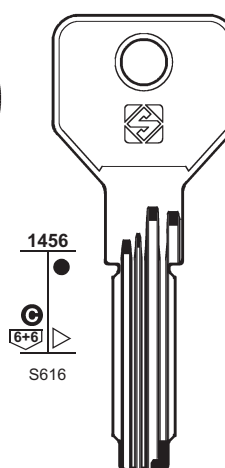
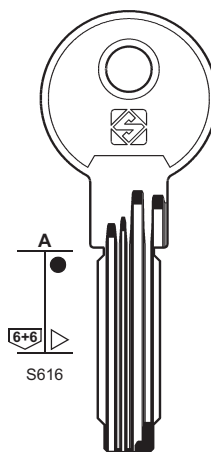
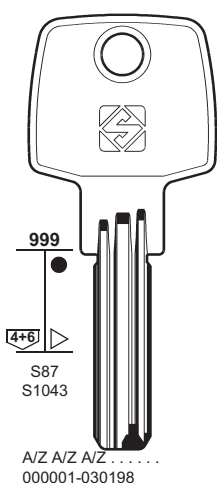
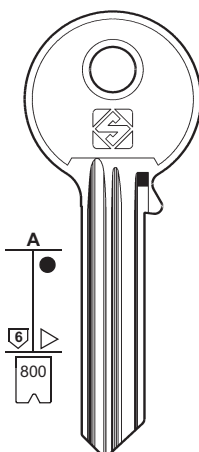
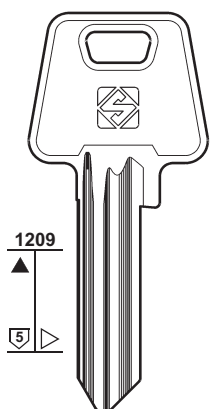

CS61

JPM



CS121

..... 0-1-2-3-4-5-6-7-8-9

ESLA



CS48



ABUS BRICARD



⊖ CS70 (W60)

..... AM 1-38832 AM



ASIX



CS146

..... AM 1-38832 AM



ASIX

PER:  
FOR:

# CISA

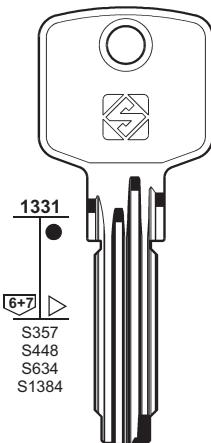

..... (XN008710) 1-11808  
..... (XN005710) 1-38832  
..... 900001-944826



CS144

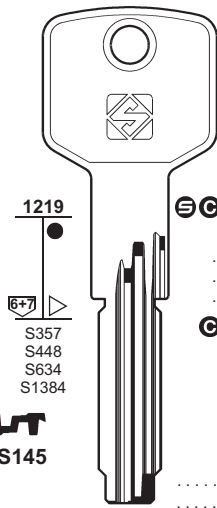

CS145



CS139

..... (XN008710) 1-11808  
..... (XN005710) 1-38832



⊖ CS62 (W08)

..... (XN008710) 1-11808  
..... (XN005710) 1-38832  
..... 900001-944826



CS115 BRICARD



CS141



CS140

..... (XN008710) 1-11808  
..... (XN005710) 1-38832

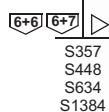
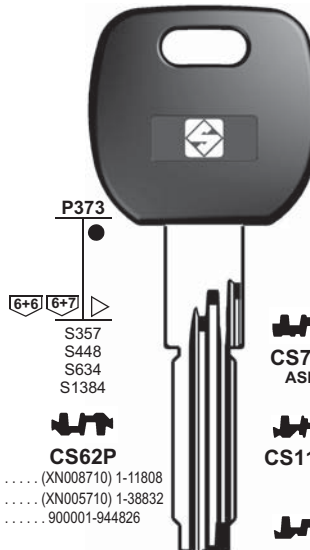

CS70P ASIX



CS62P

..... (XN008710) 1-11808  
..... (XN005710) 1-38832  
..... 900001-944826

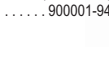

CS139P

NEW ASTRAL



50

PER / FOR

CISA (I)

- ABUS
- ALA
- BASI
- BATU
- CIBC
- CIGNO
- CITY
- IFAM
- KUNERT
- LOGO
- + ABUS (6-7-8-10)
- + ALA (13)

PER:  
FOR:

CISA

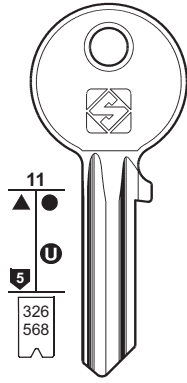

CS21 ● CS21R  
..... 1-2-3-4-5-6

CS7 CS7R  
A..... 1-01321  
..... 1-2-3-4-5-6



BATU - CIBC  
IFAM - KUNERT - LOGO

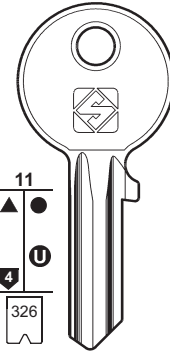

CS6 CS6R ▲ ●  
..... 1-2-3-4-5-6  
EA... 1-738



ABUS

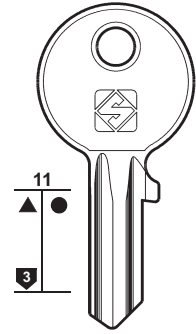

CS5 CS5R ●

LOK 2000  
ABUS

PER:  
FOR:

CISA

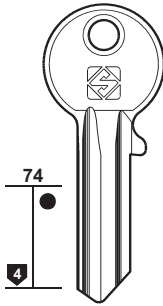

CS22 CS22R  
LOGO LOGO  
▲ ● CS8 CS8R



IFAM

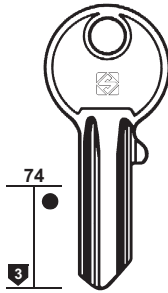

CIGNO

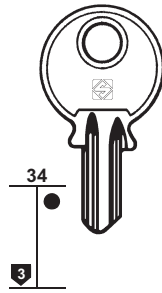

CS9 CS9R CS12 CS12R



ABUS - ALA

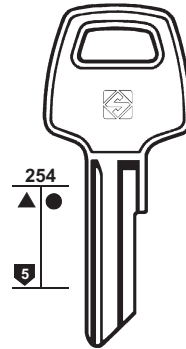

CS10 CS10R ●

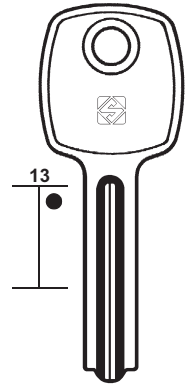

CS11



PER:  
FOR:

CISA

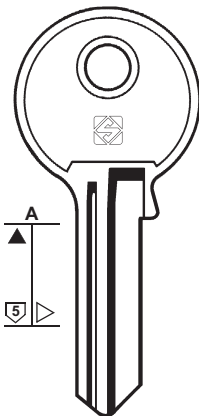

CS33 CS33R



BASI

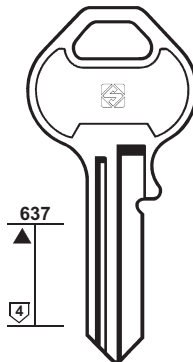

CS32 CS32R



BASI - CITY

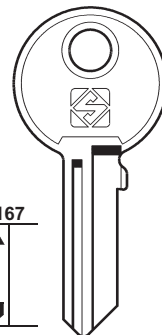

CS19 CS19R



BASI

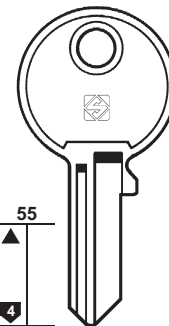

CS26 CS26R





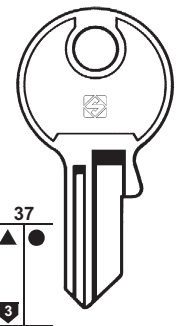







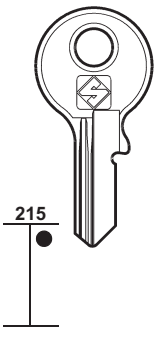
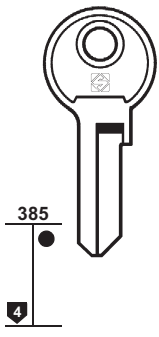
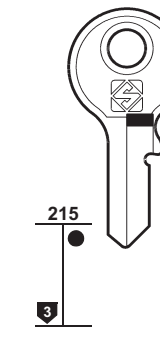
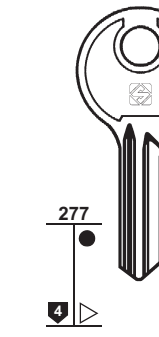
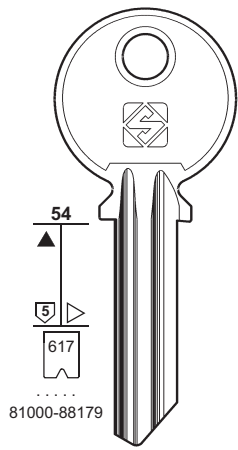



CITY



CS27 CS27R







CITY

CISA				CITY
				
215	385	215	277	54
	4	3	4	5
				617
				81000-88179
				
CS45	CS20	CS23	CS28	CA15
				
CS45R	CS20R	CS23R	CS28R	
				
		BASI - IFAM		



**51**

**PER / FOR**  
**CISA (I)**  
 BASI  
 IFAM  
 +  ABUS (6-7-8-10)  
 +  ALA (13)

**CITY (F)**  
 ATP  
 CAP  
 CAVERS  
 FO  
 PROTEC  
 QCP  
 SIAM  
 SOS  
 VIP  
 ZENITH  
 +  BUGA (36)  
 +  CISA (50)  
 +  FTH (82)









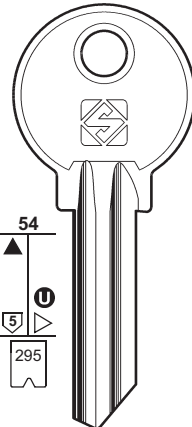
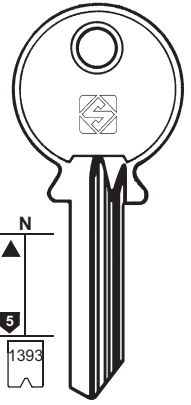

**CKS (D)**  
 YALE (193)

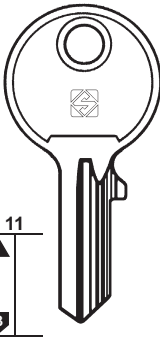



**CLAUSOR (E)**  
 BRABANTIA  
 CASH BOX  
 ELSET  
 +  ME-FA (122)





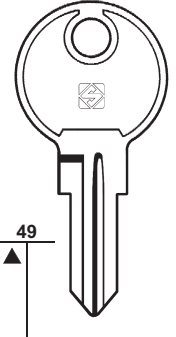
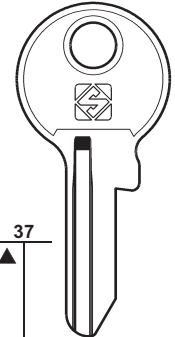





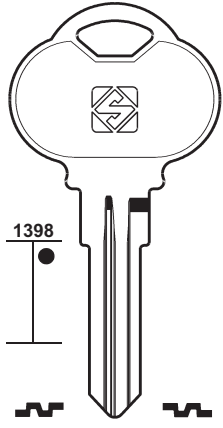
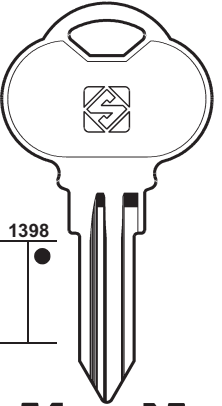

**CLUB (USA)**

**CODEM (F)**  
 FTH (83)

**CODKEY (IL)**  
 SPIDER (159)

CITY					
					
54	N	274	11	215	
5	5	4	3	3	
295	1393				
					
CA2R	CA2	CA1	CA3	CA4	CA5
	160... 000-999 16... 1000-6288	..... 25001-25075			
ATP - CAP - FO PROTEC - QCP - SIAM SOS - VIP - ZENITH		CAVERS	CAVERS	CAVERS	CAVERS

CLAUSOR	
	
49	37
	
CR2R	CR5R
	
BRABANTIA CASH BOX - ELSET	

CLUB			
			
1398	1398		
			
CLU1	CLU1R	CLU4	CLU4R
			
CLU2	CLU2R	CLU5	CLU5R
			
CLU3	CLU3R		



52

PER / FOR

COLE (USA)  
ROYAL

COLE-HERSEE (USA)  
YALE (194)

COLL (BY)

COLOMENCA (E)  
AGA (11)

COMBA (D)  
CES (42)  
KFV (105)  
TOK-WINKHAUS (170)

CONCEPT (BR)

CORBIN (I)  
MERMIER  
OAL  
POPLOCK

PER:  
FOR:

COLE

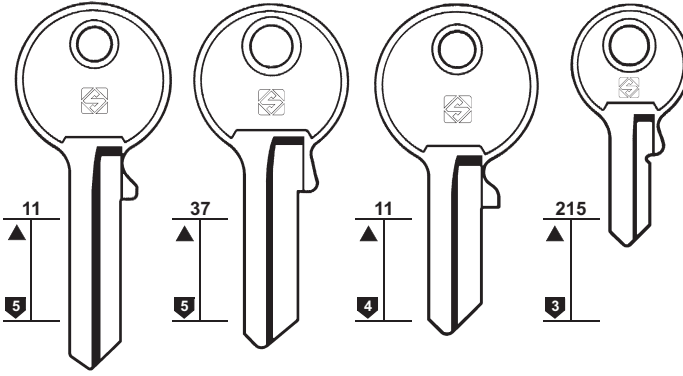

COL1



COL2



COL3



COL4



ROYAL

COLL

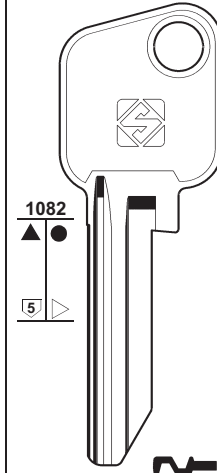

CLL1

CONCEPT

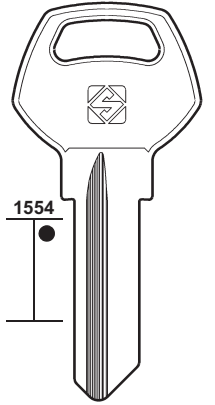

CNP1R

PER:  
FOR:

CORBIN (I)

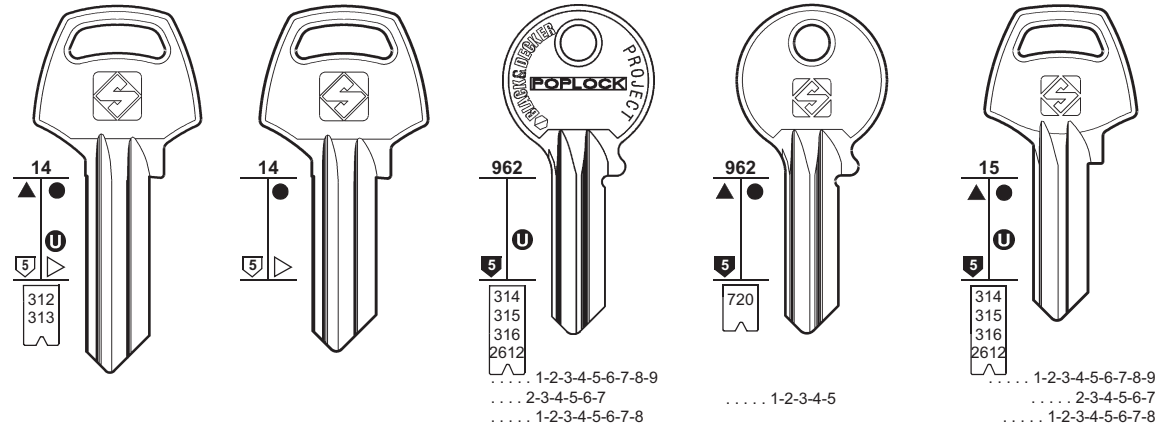

CB1 CB1R

..... 2-3-4-5-6-7-8-9  
..... 1-2-3-4-5-6-7-8-9



mm 26-45-50-60

MERMIER - OAL



CB2 CB2R



mm 23

OAL



CB3-OR

..... 1-2-3-4-5-6-7-8-9  
..... 2-3-4-5-6-7  
..... 1-2-3-4-5-6-7-8

POPLOCK



CB80



mm 21-40

OAL



CB3 CB3R

..... 1-2-3-4-5-6-7-8-9  
..... 2-3-4-5-6-7  
..... 1-2-3-4-5-6-7-8



mm 21-40

PER:  
FOR:

CORBIN (I)

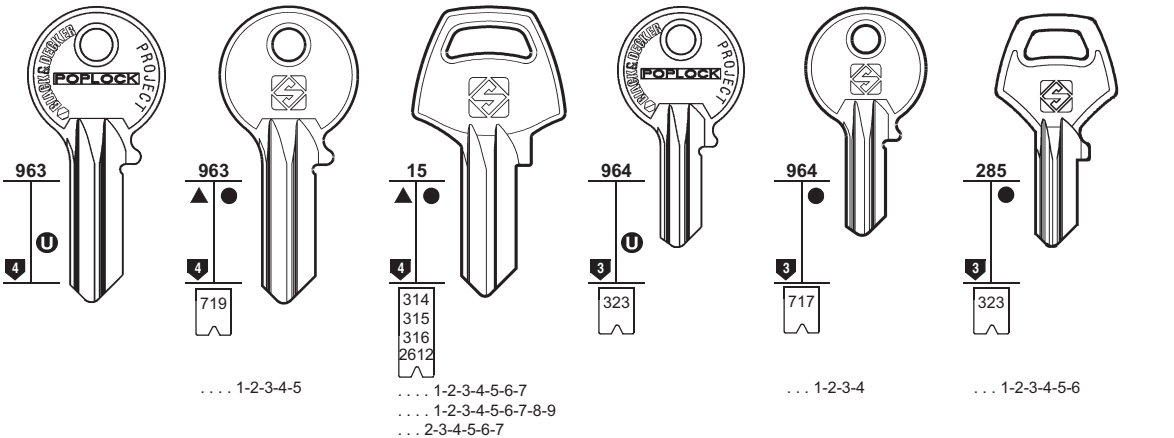

CB4-OR



CB81



CB4



CB4R



CB9-OR



CB79



CB9



mm 17,5



mm 11,5-20-25

POPLOCK

POPLOCK

PER:  
FOR:

# CORBIN (I)

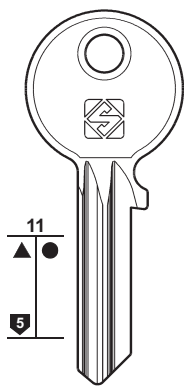

**CB85**

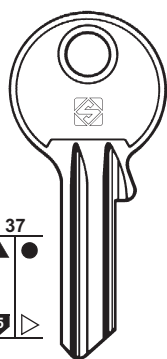

**CB15**  
025

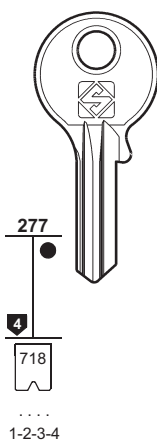

**CB70**

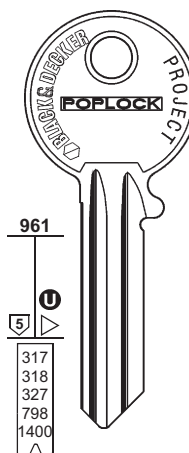

**CB6-OR**

POPLOCK



# 53

PER / FOR

## CORBIN (I)

ALUNORM  
BWS  
CRC-CAMBÒA  
DOM  
ESCO  
EURONORM  
FEB  
HEGO  
HESTE  
ISSERSTEDT  
KAWE  
LITTO  
MERMIER  
MUKRA  
NEMEF  
NOVOFERM  
POPLOCK  
STREMLER  
SUL  
TESIO  
THÒNE  
VERSCO  
WÜRTH  
ZÈCE

PER:  
FOR:

# CORBIN (I)

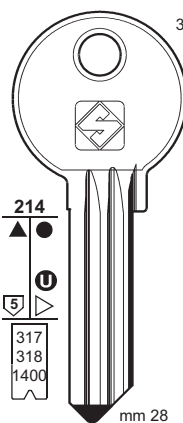

365 **CB6**  
ALUNORM  
CRC-CAMBÒA  
DOM  
ESCO  
EURONORM  
FEB  
HEGO  
HESTE  
ISSERSTEDT  
KAWE  
LITTO  
MERMIER  
MUKRA  
NEMEF  
NOVOFERM  
STREMLER  
SUL  
THÒNE  
VERSCO  
WÜRTH  
ZÈCE

..... 1-2-3-4-5-6-7-8-9  
..... 0-1-2-3-4-5-6-7-8  
..... 8-7-6-5-4-3-2-1-0  
..... 012345678  
..... 123456  
DX ..... 123456  
..... 123456789  
..... 876543210

BWS



**CB6R**



**CB16**  
A1



**CB17**



**CB19**  
B1



**CB95R**



**CB32**



**CB96R**



**CB42**



**CB99R**



**CB43R**



**CB100R**



**CB78R**



**CB101R**

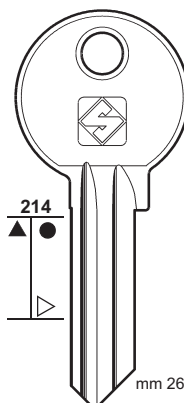

mm 26

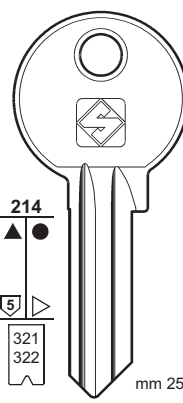

mm 25

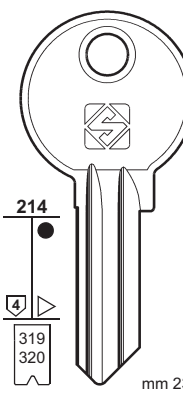

mm 23



**CB5**



**CB5R**



**CB8**

..... 2-3-4-5-6-7-8  
..... 1-2-3-4-5-6-7-8-9



**CB7**



**CB7R**

..... 1-2-3-4-5-6-7  
..... 2-3-4-5-6-7

ESCO - EURONORM  
KAWE - MUKRA

PER:  
FOR:

# CORBIN (I)

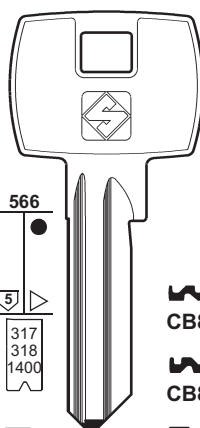

**CB89R**

**CB88R**



**CB31**



**CB30**

**CB84**

..... 1-2-3-4-5-6-7

**CB30R**

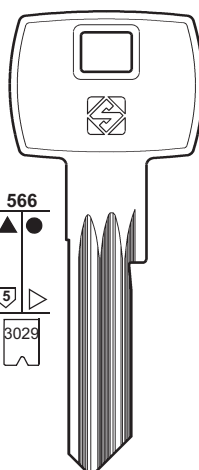

**CB90R**

**CB86**

..... 1-2-3-4-5-6-7

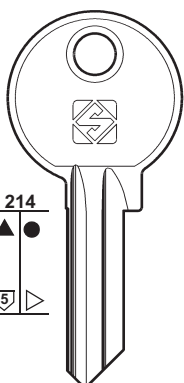

**CB21**

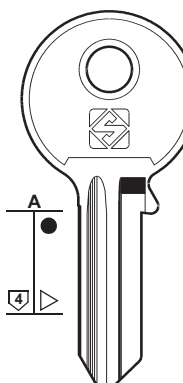

**CB83**

TESIO





54

PER / FOR

CORBIN (I)

CORBIN (AUS)  
LANE

CORBIN (USA)  
SKILMANN

PER:  
FOR:

CORBIN (I)

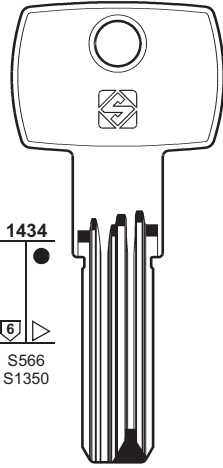

1434  
6  
S566  
S1350



CB87

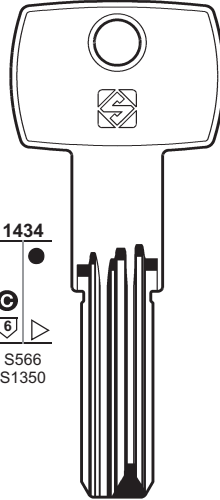

1434  
6  
S566  
S1350



CB97



"Euro Star Plus"

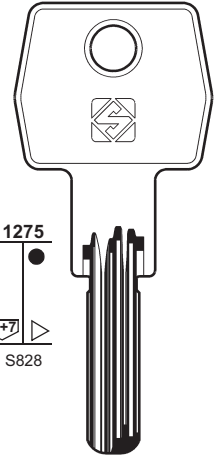

1275  
6+7  
S828



CB98



PER:  
FOR:

CORBIN (USA)

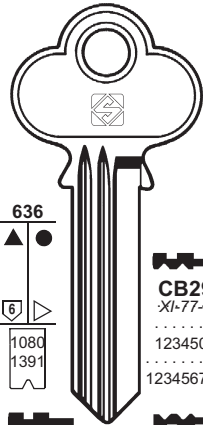

636  
6  
1080  
1391



CB12



CB12R

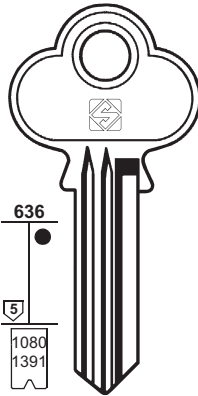

636  
5  
1080  
1391

CB29  
XI-77-6  
1234506  
123456789



CB29R



CB82



CB11

XI-77-5  
1234567890



CB11R

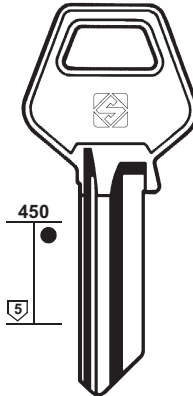

450  
5



CB18

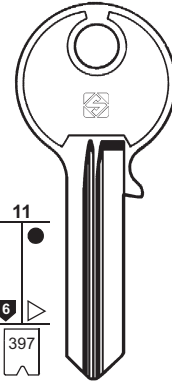

11  
6  
397



CB28R

4R .....  
0-1-2-3-4-5-6-7-8

9R .....  
0-1-2-3-4-5-6-7-8

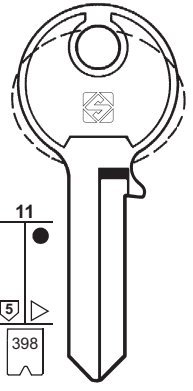

11  
5  
398



CB38

B4R .....  
0-1-2-3-4-5-6-7-8-9

4T .....  
0-1-2-3-4-5-6-7-8-9



CB37

1234567890



CB39R

1234506  
1234567890

SKILMANN

PER:  
FOR:

CORBIN (USA)

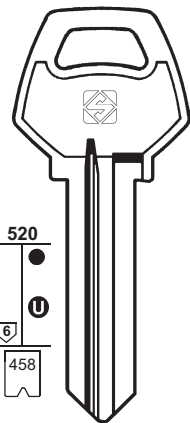

520  
6  
458



CB34R  
1234567

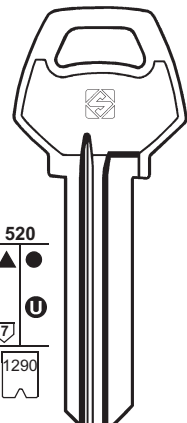

520  
7  
1290



CB25R  
1234506



CB40R  
1234506

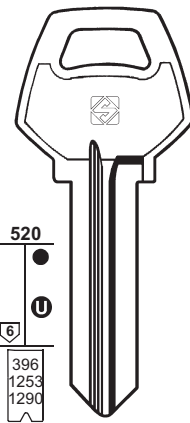

520  
6  
396  
1253  
1290



CB26R  
1234506  
1234567890  
M ..... 1234567890



CB33R  
1234506  
0123456789A  
M ..... 1234567890  
1234567

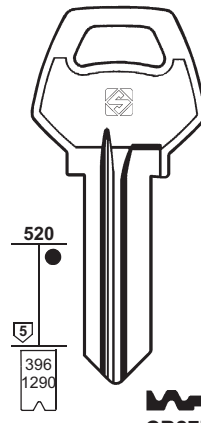

520  
5  
396  
1290



CB27R

1234506  
1234567890  
M ..... 1234567890



CB24R



CB41R

1234567890  
M ..... 1234567890

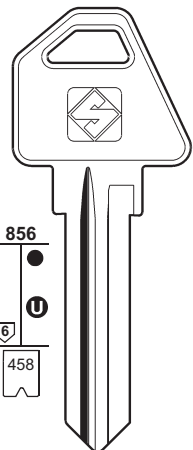

856  
6  
458



CB44R

1-2-3-4-5-6-7

CORBIN (AUS)  
LANE

CB23R  
1234567890  
M ..... 1234567890

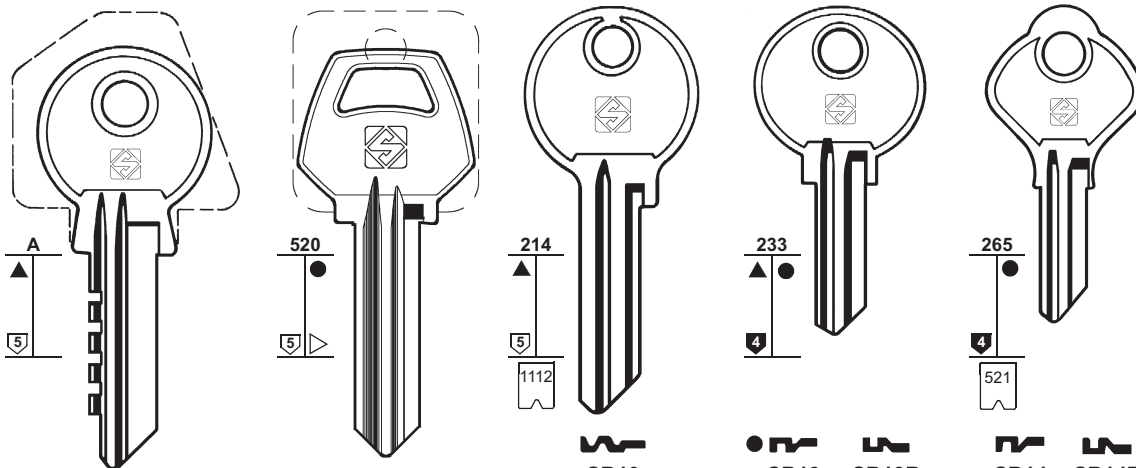

**CB20**

**CB102R**

**CB10**

**CB13**

**CB13R**

**CB14**

**CB14R**

2A ..... 0-1-2-3-4-5-6-7-8-9  
7A ..... 0-1-2-3-4-5-6-7-8-9  
8P ..... 0-1-2-3-4-5-6-7-8-9

BGM ...  
CAT ...  
1-200

EMHART

CHANGE-O-MATIC

CCL



**55**

PER / FOR

**CORBIN** (USA)  
CCL  
CHANGE-O-MATIC  
EMHART

**CORNI** (I)

333  
BETA  
CIC  
EURONORM  
FONTAINE  
MUL.T.LOCK

**CORONA** (D)

BAB  
BUG  
DOCU  
GEBRO  
ZEISS IKON  
+ BAB (26)  
+ ZEISS IKON (201)

**COTICO** (D)

**COUILLET** (F)  
 RICOUARD (146)

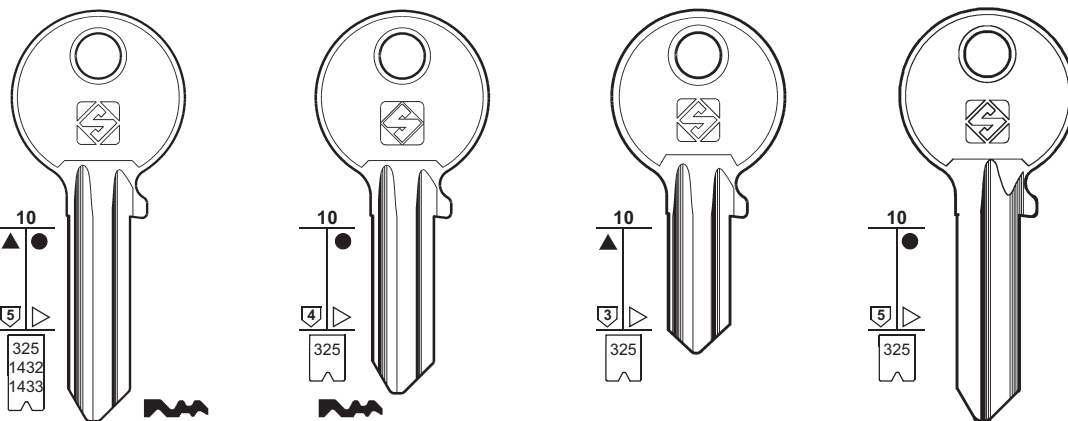

**CC5**  
48 ..... 1-1000

**CC4** ..... 0-1-2-3-4-5-6-7-8-9

**CC2**  
48 ..... 1-1000

**CC2R**  
48 ..... 1-1000  
..... 28001-29000  
..... 80000-80625  
..... 85000-86000  
..... 86000-87000

**CC3** **CC3R**  
..... 0-1-2-3-4-5-6-7-8-9

**CC7** **CC7R**  
..... 0-1-2-3-4-5-6-7-8-9

**CC6R**  
..... 0-1-2-3-4-5-6-7-8-9

333 - BETA - CIC

BETA  
EURONORM

BETA

FONTAINE  
MUL.T.LOCK

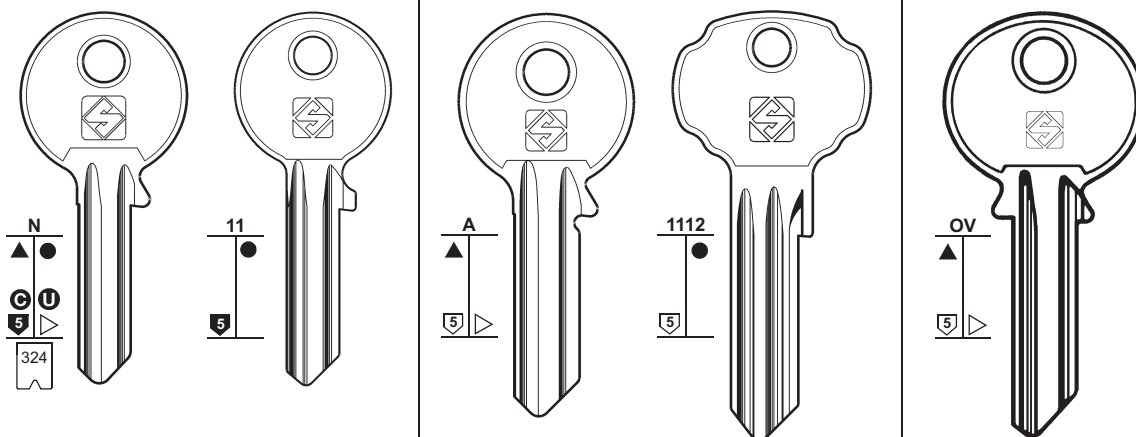

**CC1** **CC1R**  
.....  
1-2-3-4-5

**CC8**

**COR1**

**COR2** **COR2R**

**CO1** **CO1R**

BAB - BUG - DOCU  
GEBRO - ZEISS IKON



56

PER / FOR

C.R. (I)

CRC-CAMBÔA (P)  
CORBIN (53)

CRISTANI (I)  
R.C.

CROWN (RC)

CVL (E)

CWS (D)  
DOM (61)

DAC (GR)

DAD (F)  
DECAEUX  
+ FORT (81)  
+ L & F (116-117)  
+ RONIS (146)  
+ VACHETTE (181)

DAF (TR)

PER:  
FOR:

C.R.

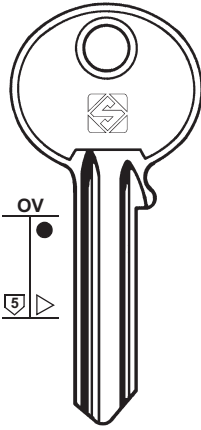

CRISTANI

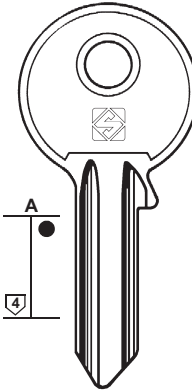
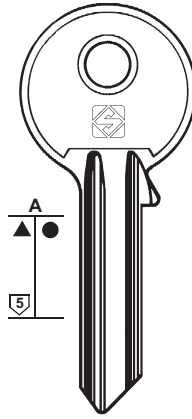

R.C.

CROWN

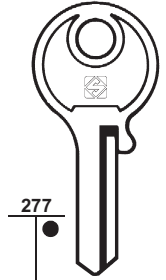

PER:  
FOR:

CVL

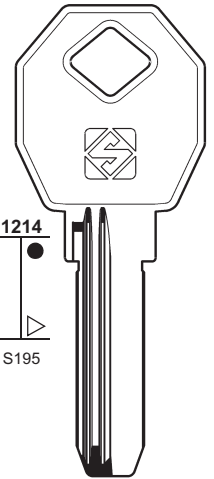
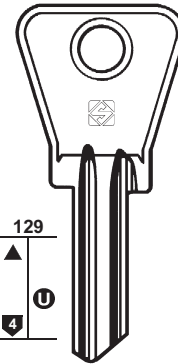
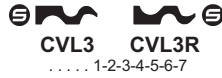
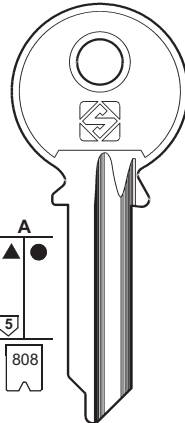
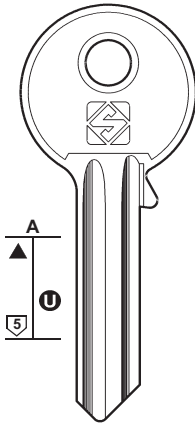

PER:  
FOR:

DAC

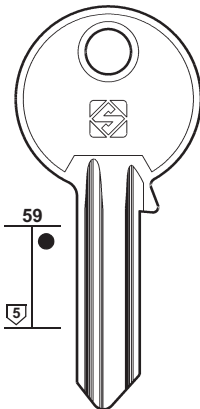

DAD

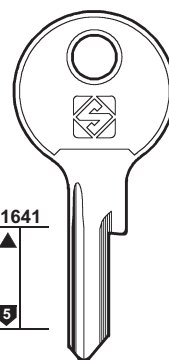
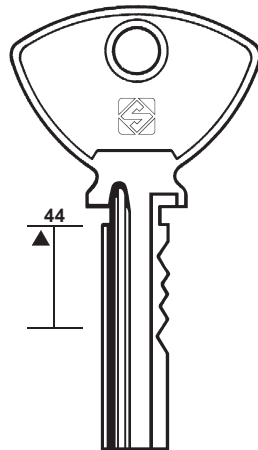

DECAEUX



DAF

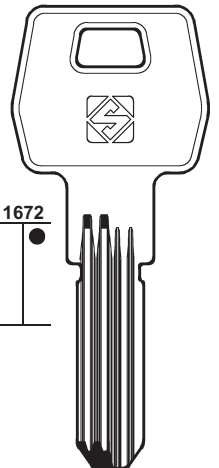
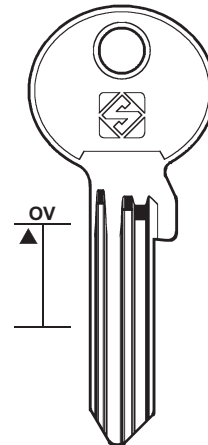

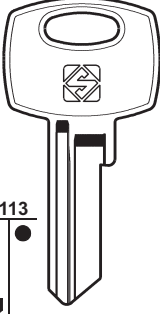
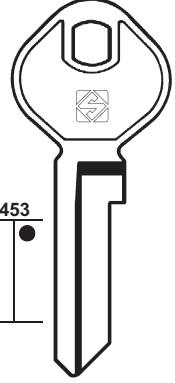
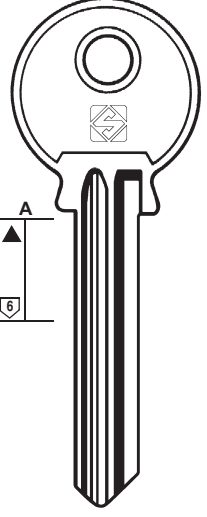
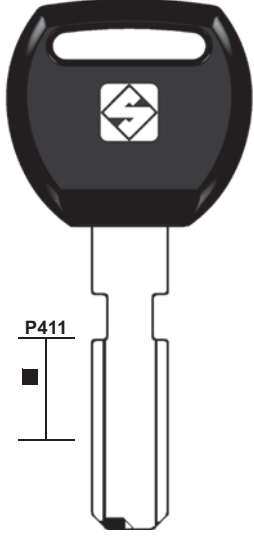

<p>PER: FOR: <b>DAIYA</b></p>  <p>1113 1640</p> <p><b>DY1</b> ..... 4801-9600 K..... 1-960</p> <p><b>DY1R</b> ..... 1-4800 S..... 1-960</p>	<p>PER: FOR: <b>DALWA</b></p>  <p>453</p> <p><b>DAL1</b></p> <p><b>DAL2</b>   <b>DAL2R</b></p> <p>LIPS</p>	<p>PER: FOR: <b>DE ANGELI</b></p>  <p>A 6</p> <p><b>DEA2</b></p>	<p>PER: FOR: <b>DEFEND LOCK</b></p>  <p>P411</p> <p><b>DFE1RP</b></p>
--	---	---	---

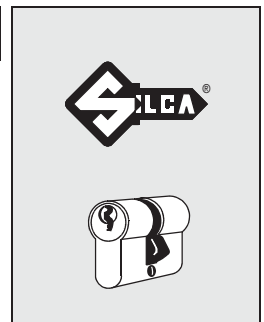

**57**

PER / FOR
<b>DAIYA</b> (RC)
<b>DALWA</b> (J) LIPS
<b>DAMM</b> (D) 👁️ BKS (30)
<b>DAV</b> (F) 👁️ RONIS (147)
<b>DC</b> (F) 👁️ RONIS (146)
<b>DE ANGELI</b> (I)
<b>DEBEAURAIN</b> (F) 👁️ RONIS (146)
<b>DECAYEUX</b> (F) 👁️ DAD (56) 👁️ DOM (62) 👁️ FORT (81) 👁️ O.NOVOX (136) 👁️ PICARDIE (141) 👁️ RICOUARD (146)
<b>DEF</b> (F) 👁️ KIFERM (106)
<b>DEFEND LOCK</b> (CZ)
<b>DEHA</b> (RC) 👁️ YETI (198-199)
<b>DEKABA</b> (BG) MAUER

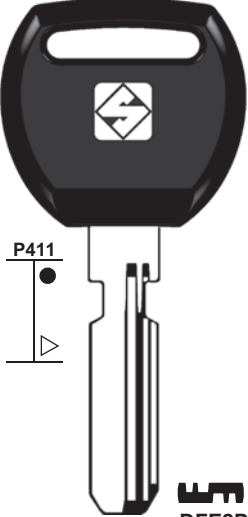
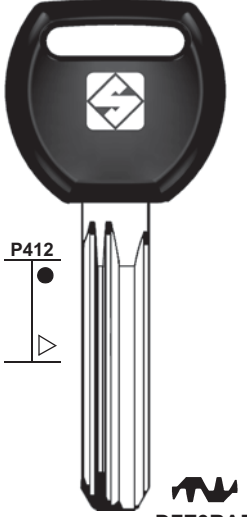
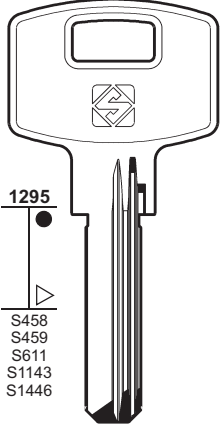
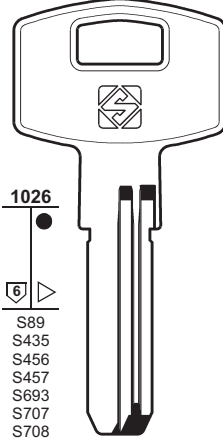
<p>PER: FOR: <b>DEFEND LOCK</b></p>  <p>P411</p> <p><b>DFE2P</b></p>	<p>PER: FOR: <b>DEKABA</b></p>  <p>P412</p> <p><b>DFE3RAP</b></p>	<p>PER: FOR: <b>DEKABA</b></p>  <p>1295</p> <p>S458 S459 S611 S1143 S1446</p> <p><b>DK1</b> ..... 00001-85798 ..... 000001-028000</p> <p>MAUER</p>	<p>PER: FOR: <b>DEKABA</b></p>  <p>1026</p> <p>S89 S435 S456 S457 S693 S707 S708 S1144 ..... 000016-280006</p> <p><b>DK3</b>   <b>DK6</b> E2   E2</p> <p>MAUER</p>
--	---	--	---

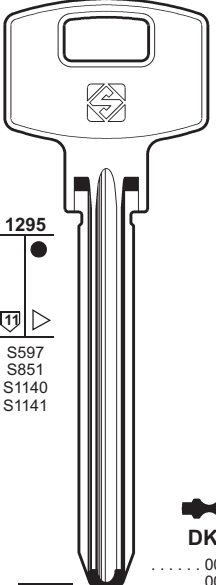
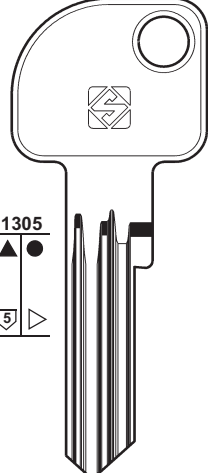
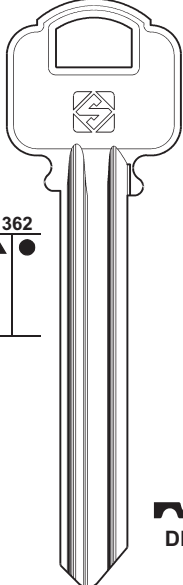
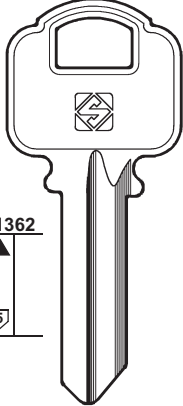
<p>PER: FOR: <b>DEKABA</b></p>  <p>1295</p> <p>S597 S851 S1140 S1141</p> <p><b>DK7</b> ..... 000002-111985 ..... 000003-129307</p> <p>MAUER</p>	<p>PER: FOR: <b>DEKABA</b></p>  <p>1305</p> <p><b>DK5</b> F</p> <p>MAUER</p>	<p>PER: FOR: <b>DEKABA</b></p>  <p>1362</p> <p><b>DK4</b></p> <p>MAUER</p>	<p>PER: FOR: <b>DEKABA</b></p>  <p>1362</p> <p><b>DK8R</b>   <b>DK9R</b></p> <p>MAUER</p>
--	---	---	--



58

PER / FOR

DELCA (GR)  
GEVY

DELTA (F)  
RONIS (146)

DERLOCHE (F)  
RONIS (146)

DESPREZ (F)  
GABON (84)  
RONIS (146)

DETHLEF (GB)  
EURO-LOCKS (71)

DEXTER (I)

DIAMA (F)  
FTH (82)

DIAMOND (RC)

PER:  
FOR:

DELCA

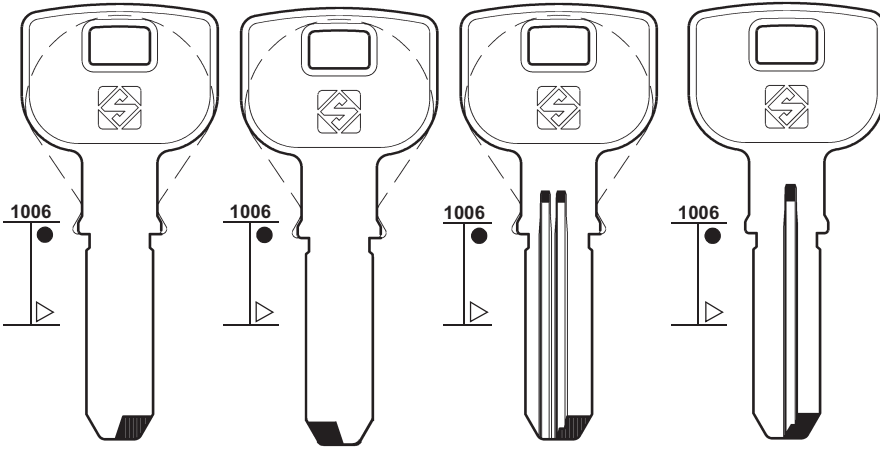

DLC1

DLC1R

DLC2R

DLC3



DEXTER

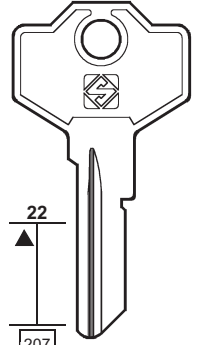

E....  
9001-9741

GS4R



PER:  
FOR:

DEXTER

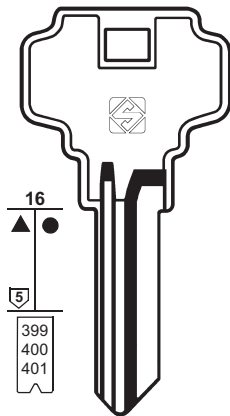

399  
400  
401

GM  
DX18R

B2  
DX6R

DX1

DX1R ▲ ●

BM  
DX2R

..... 0-1-2-3-4-5-6-7  
..... 0-1-2-3-4-5-6-7  
..... 0-1-2-3-4-5-6-7-8-9  
..... T 0-1-2-3-4-5-6-7-8-9

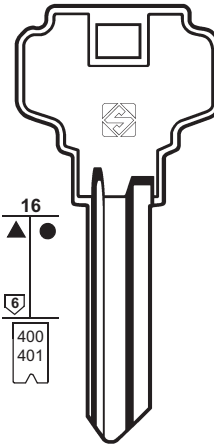

400  
401

GM  
DX17R ▲

CM  
DX15R ▲

D3  
DX13R ●

DX3 DX3R

B1  
DX4R ▲

..... 0-1-2-3-4-5-6-7  
..... 0-1-2-3-4-5-6-7-8-9  
..... T 0-1-2-3-4-5-6-7-8-9

PER:  
FOR:

DIAMOND

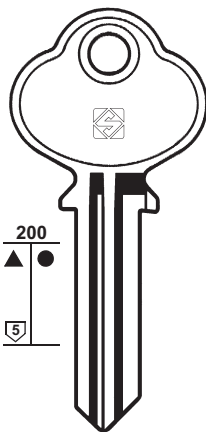

DN2

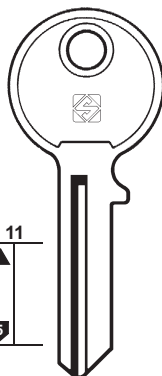

DN3

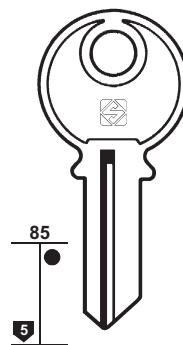

DN1



DN9R

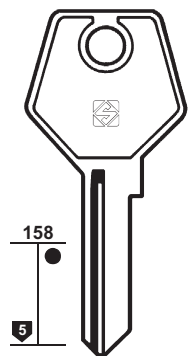

DN4



PER:  
FOR:

# DIAMOND

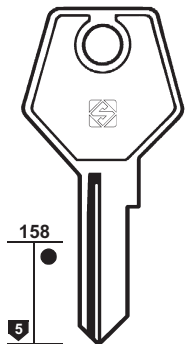

DN5

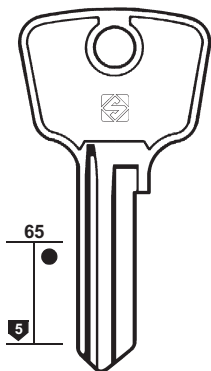

DN7

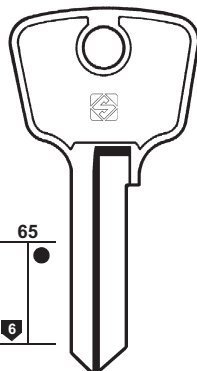

DN6

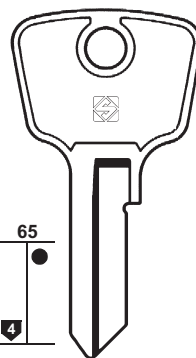

DN8



# 59

PER / FOR

**DIAMOND** (RC)

**DIERRE** (D)  
+ WILKA (191)

**DIFA** (DK)  
+ RUKO (148)

**DIMITROVGRAD**  
(RUS)

**DISQUIN** (F)  
+ TOK-WINKHAUS (169)

**DLP**  
**(D. LA PORTE)** (D)  
+ LA PORTE (110)

**DNEPROPETROVSK**  
(UA)  
FIMANEVSKI

**DNS** (GB)  
+ EAGLE (67)

**DOBLINA** (D)

PER:  
FOR:

## DIERRE

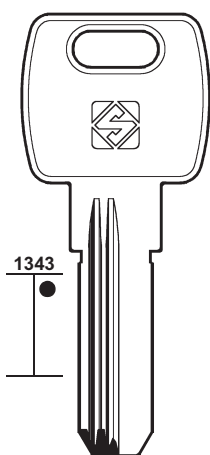

DIR1R



## DIMITROVGRAD

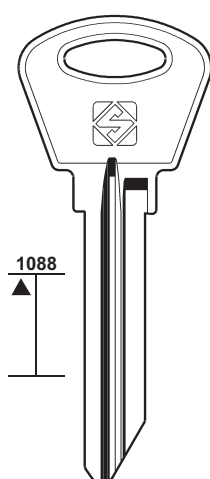

DMT1R

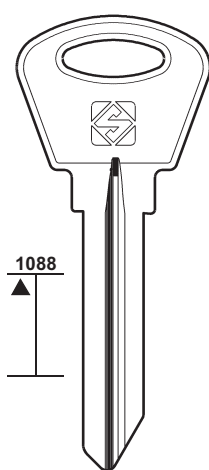

RUS3R



DMT2R

## DLP (D. LA PORTE)

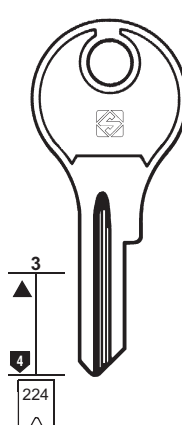

DL1R

... 2501-2550

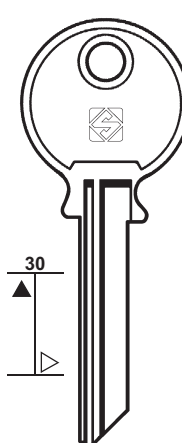

LAP3

PER:  
FOR:

## DLP (D. LA PORTE)

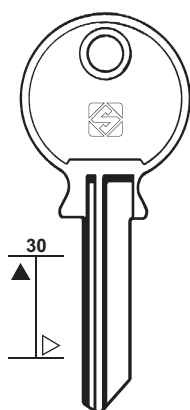

LAP2

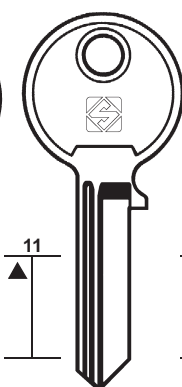

DL3

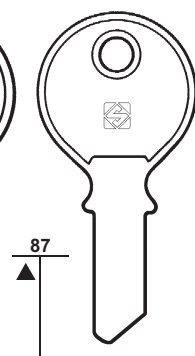

DL2

## DNEPROPETROVSK

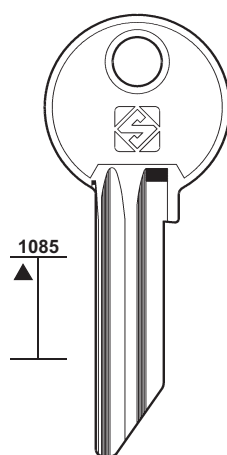

FMK1

FIMANEVSKI

## DOBLINA

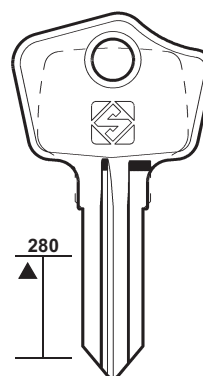

DB60



60

PER / FOR

DOBLINA (D)

DOBUS (D)  
CISA (48)

DOCO (D)  
CORONA (55)

DOFIN (F)  
GLOBE (87)

DOM (D)  
LISTA  
NOBO  
+ CORBIN (52)  
+ EMR (69)  
+ MLM (127)  
+ STUV (163)

PER:  
FOR:

DOBLINA

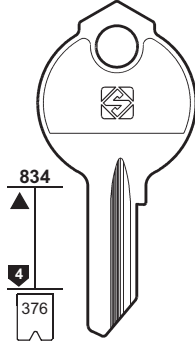

... 201-626

DB1 35 ...	DB1R 34 ...	DB12 22 ...	DB12R 23 ...	DB28 120 ...	DB28R 121 ...	DB44 H ...	DB44R G ...
DB2 U ...	DB2R V ...	DB13 25 ...	DB13R 24 ...	DB29 122 ...	DB29R 123 ...	DB45 L ...	DB45R K ...
DB3 2 ...	DB3R 1 ...	DB14 27 ...	DB14R 26 ...	DB30 125 ...	DB30R 124 ...	DB46 M ...	DB46R N ...
DB4 3 ...	DB4R 4 ...	DB15 29 ...	DB15R 28 ...	DB31 130 ...	DB31R 131 ...	DB47 P ...	DB47R R ...
DB5 6 ...	DB5R 5 ...	DB16 31 ...	DB16R 30 ...	DB32 132 ...	DB32R 133 ...	DB48 S ...	DB48R T ...
DB6 8 ...	DB6R 7 ...	DB17 32 ...	DB17R 33 ...	DB33 134 ...	DB33R 135 ...	DB49 Y ...	DB49R Z ...
DB7 11 ...	DB7R 12 ...	DB18 36 ...	DB18R 37 ...	DB34 136 ...	DB34R 137 ...	DB50 1Z ...	DB50R 1Y ...
DB8 14 ...	DB8R 13 ...	DB19 39 ...	DB19R 38 ...	DB35 138 ...	DB35R 139 ...	DB51 1A ...	DB51R 1B ...
DB9 15 ...	DB9R 16 ...	DB20 40 ...	DB20R 41 ...	DB36 141 ...	DB36R 140 ...	DB53 1E ...	DB53R 1F ...
DB10 17 ...	DB10R 18 ...	DB21 42 ...	DB21R 43 ...	DB37 142 ...	DB37R 143 ...	DB54 1H ...	DB54R 1G ...
DB11 20 ...	DB11R 21 ...	DB22 44 ...	DB22R 45 ...	DB38 145 ...	DB38R 144 ...	DB55 1K ...	DB55R 1L ...
		DB23 47 ...	DB23R 46 ...	DB39 147 ...	DB39R 146 ...	DB56 1M ...	DB56R 1N ...
		DB24 48 ...	DB24R 49 ...	DB40 148 ...	DB40R 149 ...	DB57 1R ...	DB57R 1P ...
		DB25 51 ...	DB25R 50 ...	DB41 B ...	DB41R A ...	DB58 1T ...	DB58R 1S ...
		DB26 53 ...	DB26R 52 ...	DB42 D ...	DB42R C ...	DB59 1X ...	DB59R 1W ...
		DB27 54 ...	DB27R 55 ...	DB43 F ...	DB43R E ...		

PER:  
FOR:

DOM

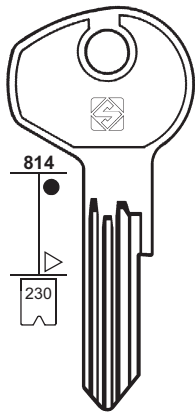

ZDDM ... 101-150  
7F ... (KN)  
1F ... 501-513  
YSNR ... 201-275  
YVLF ... (KN) 201-275  
YZFZ ... (KN) 201-275

DM106

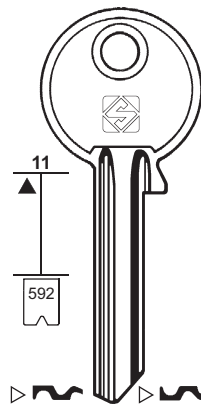

DM13 4 DM13R 3

DM96 1E ... 1-160

DM104R KNK

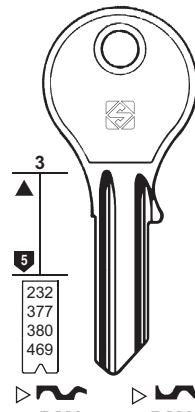

DM2 3 DM2R 4  
EV ... 1-2840  
GS ... 1-1000  
FT ... 1-1000  
CQ ... 301-400  
... 1-1000

DM62 DM62R



NOBO

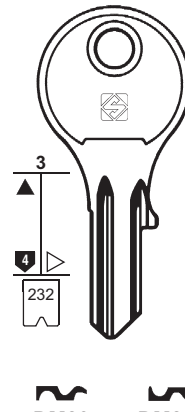

DM23 29 DM23R 3  
CL ... 501-750  
ED ... 1-380  
EG ... 1-250



LISTA

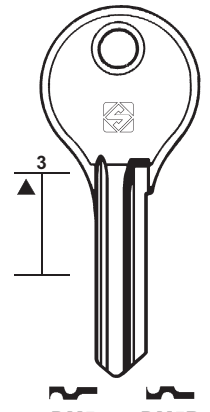

DM5 DM5R



PER:  
FOR:

### DOM

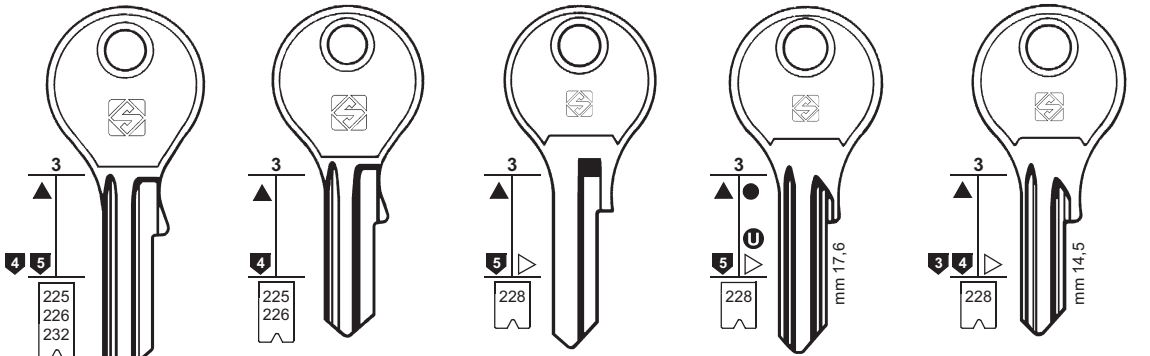

**DM4** ..... 80138-80748  
..... 80761-83242  
DN ... 1-120

**DM4R**

**DM6** ..... 80138-80748  
..... 80761-83242

**DM39** ..... 6E ... 1-205  
..... 7E ... 269-473

**DM39R**

**DM8** 2D ... 1-222  
5A ... 1-2600  
9A ... 1-5200  
W ... 1-50  
1D ... 601-654  
2W ... 1-50

**DM8R**

**DM10** 2A ... 1-34  
DB ... 1-148  
CF ... 1-140  
3A ... 1-82  
4A ... 1-482  
1D ... 501-560  
1D ... 1-57  
FG ... 1-615  
FS ... 1-60

**DM10R** 1D ... 58-114  
2A ... 35-68

**DM61** GS ... 1-1000  
..... 1-1000

**DM61R**

**DM6R** ..... 80138-80748  
GP ... 1-250  
C ... 1001-1200  
CL ... 1-250  
C ... 1301-1500

**BARRO - IDEAL - TM**

**CHRIST**

**EAO - SWISSTAC**

**BTV - DECAEUX**  
**HÄFELE - HEKNA**  
**HUWIL - METEOR**  
**MLM - RUKA**  
**SCHLEGEL - STS**

**CWS - HÄFELE**  
**HEKNA - HUWIL**  
**MENOVA - METEOR**  
**MLM - RUKA**  
**SINJET**



# 61

PER / FOR

**DOM (D)**  
BARRO  
BTV  
CHRIST  
CWS  
DECAEUX  
EAO  
FLAMBO  
GEWIRU  
HÄFELE  
HEKNA  
HUWIL  
IDEAL  
MENOVA  
METEOR  
MLM  
NOBO  
PEROHAUS  
RAFI  
RUKA  
SCHLEGEL  
SINJET  
STS  
SWISSTAC  
TM  
+ CORBIN (52)  
+ EMR (69)  
+ MLM (127)  
+ STUV (163)

PER:  
FOR:

### DOM

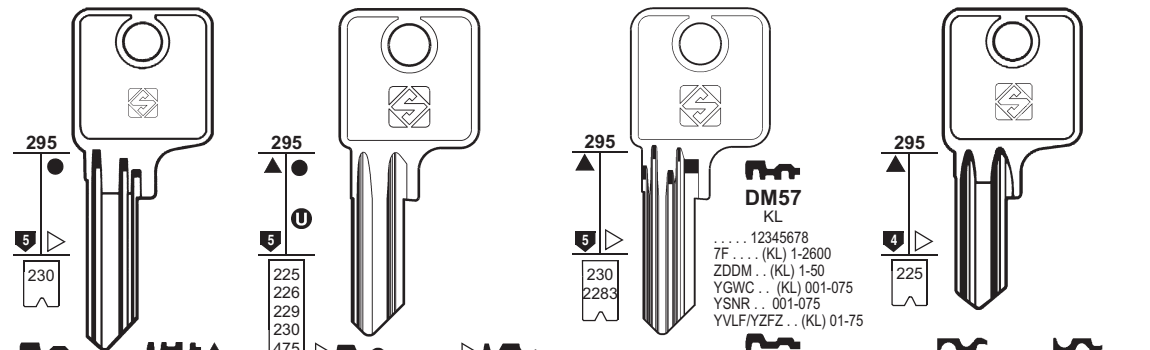

**DM41** ..... 12345678  
7F ... (KL) 1-2600  
ZDDM ... (KL) 1-50  
YGWC ... (KL) 001-075  
YSNR ... 001-075  
YVLF/YZFE ... (KL) 01-75

**DM41R**

**DM16** DC ... 1-1800  
K ... 1-50  
GD ... 1-1800  
GZ ... 1-1800  
3E ... 1-350  
2C ... 1-2600

**DM16R**

**DM102** VN ..... WS .....  
**DM111** YSNR ... (WS) 2701-2775  
YZFZ ... (WS) 2701-2775

**DM37** .....  
**DM36** C ... 1001-1200  
CL ... 1-250  
GP ... 1-250  
C ... 1301-1500

**DM37R**

**DM101** .....  
**DM113** YSNR ... (WL) 2701-2775  
YZFZ ... (WL) 2701-2775

**DM19** DN ... 1-120  
..... 80138-80748  
..... 80761-83242

**DM19R** YSNR ... (WL) 2701-2775  
YZFZ ... (WL) 2701-2775

**DM112** YSNR ... (WS) 2701-2775  
YZFZ ... (WS) 2701-2775

**DM113**

**DM137**

**DM149**

**FLAMBO - HEKNA**  
**NOBO - PEROHAUS**

**GEWIRU**

PER:  
FOR:

### DOM

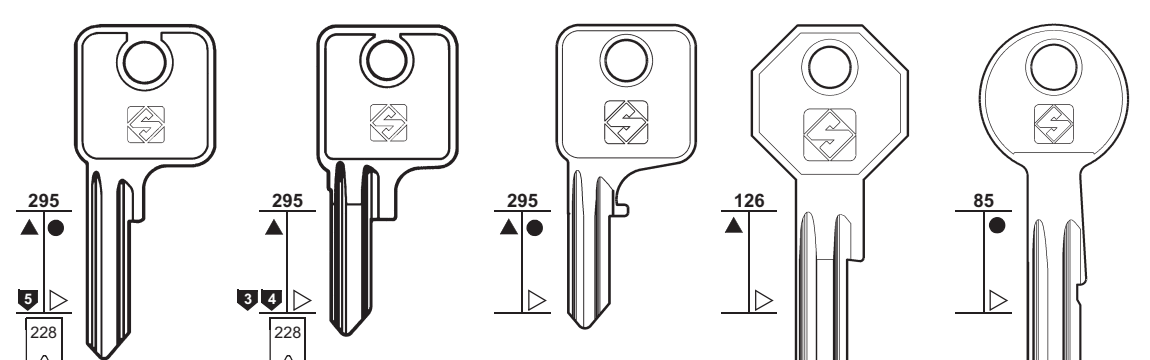

**DM63** 2D ... 1-222  
5A ... 1-2600  
9A ... 1-5200  
W ... 1-50

**DM63R**

**DM34** CF ... 1-140  
DB ... 1-148  
2A ... 1-34  
4A ... 1-482  
1D ... 1-57  
FG ... 1-615  
3A ... 1-82  
1D ... 501-560

**DM34R** 1D ... 58-114  
2A ... 35-68

**DM110**

**DM116**

**DM114**

**BMW**

**RAFI**



62

PER / FOR

DOM (D)  
 CORBIN  
 DYES  
 EMHART  
 FORTSCHRITT  
 HÄFELE  
 HÖHRMANN  
 LISTA  
 MAQUET  
 MARCO  
 MIPPART  
 MLM  
 STEIGA  
 STS  
 STUV  
 VARIO  
 VIKI  
 VOKO

- + CORBIN (52)
- + EMR (69)
- + MLM (127)
- + STUV (163)

PER:  
FOR:

DOM

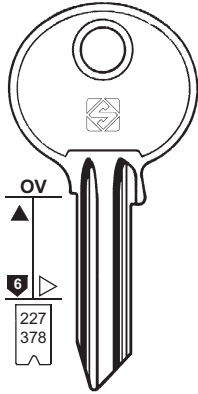

**DM7** **DM35R**  
 FA ... 1-3948  
 CD ... 1-500

VARIO

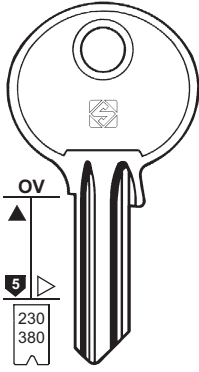

**DM25**  
 EV ... 1-2840  
 4C ... 1-3000

HÖHRMANN

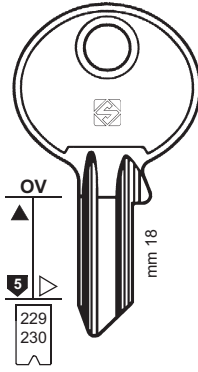

**DM48**  
 2C ... 1-2600  
 DC ... 1-1800  
 3E ... 1-350  
 GD ... 1-1800  
 GZ ... 1-1800  
 1C ... 1-363

DYES - FORTSCHRITT - HÄFELE  
 LISTA - MAQUET - MARCO  
 MIPPART - MLM - VOKO

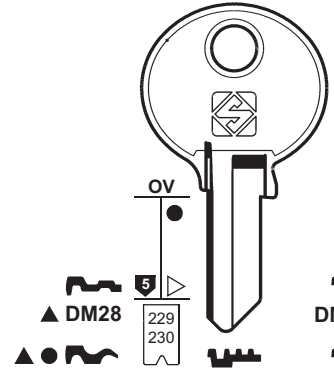

**DM11**  
 2C ... 1-2600  
 DC ... 1-1800  
 3E ... 1-350  
 GD ... 1-1800  
 GZ ... 1-1800  
 1C ... 1-363  
 TB ... 1-1796  
 YSNR ... (VN) 1201-1275  
 YSNR ... (WN) 2201-2275  
 YZfZ ... (VN) 1201-1275

**DM123-1** **DM123-7**  
**DM123-2** **DM123-8**  
**DM123-3** **DM123-9**  
**DM123-4** **DM123-10**

PER:  
FOR:

DOM

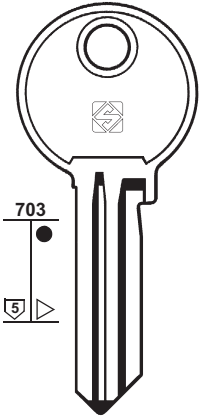

**DM98R**  
 E

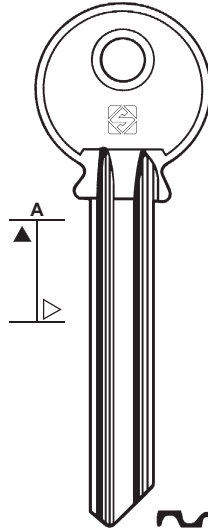

**DM32**

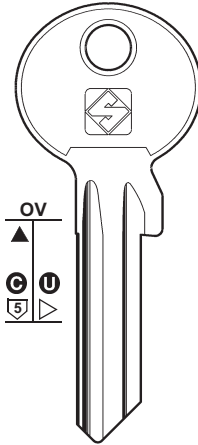

**DM3X**

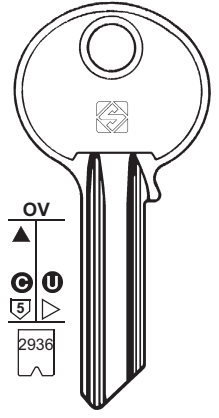

**DM3** **DM105R**  
 ..... 01234567

STEIGA  
STUV - VIKI

PER:  
FOR:

DOM

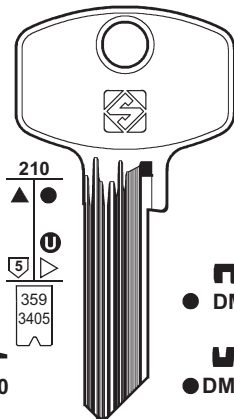

**DM150**  
 210  
 359  
 3405

**DM20**  
 ..... PT 129893-130092

**DM14**  
 0-1-2-3-4-5-6-7-8-9  
 ..... PT  
 129893-130092

**DM103**  
**DM141R**  
**DM97R**

**DM119**  
 CORBIN  
 ..... 0123456789  
 ..... 0123456789

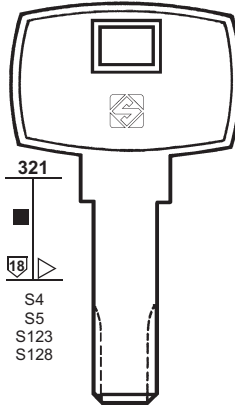

321  
 S4  
 S5  
 S123  
 S128

**DM22**



CORBIN - EMHART

**DM22TVP**  
**DM22TV5** **DM22TV10**  
**DM22TV4** **DM22TV9**  
**DM22TV3** **DM22TV8**  
**DM22TV2** **DM22TV7**  
**DM22TV1** **DM22TV6**

PER:  
FOR:

### DOM

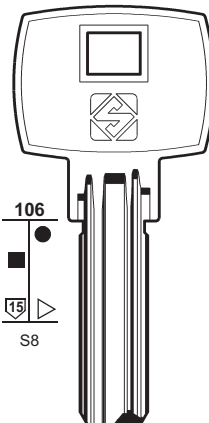
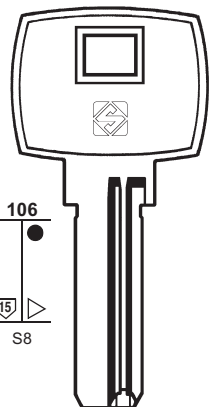
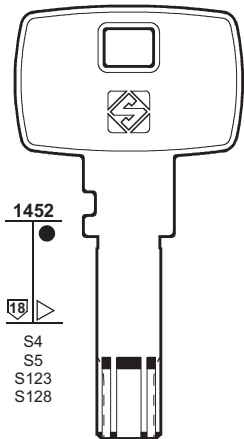

**DM22TVPX** **DM22TV5X**

**DM24** **DM64**  
IX5

**DM118**

**DM120** **DM122**



# 63

PER / FOR

**DOM (D)**

ASPA  
CORBIN  
EMHART  
IR  
LAPERCHE  
MOREAUX  
NOBO  
STS

- + CORBIN (52)
- + EMR (69)
- + MLM (127)
- + STUV (163)

PER:  
FOR:

### DOM

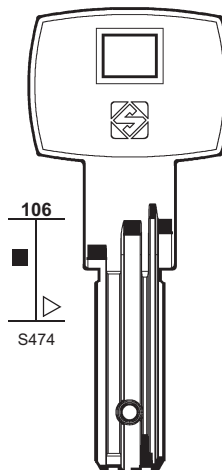
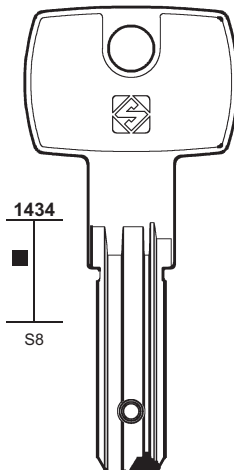
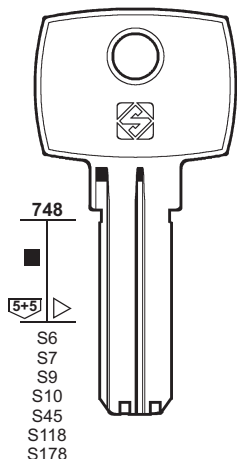

**DM49** **DM53**

**DM139** **DM145**  
IX5

**DM144**  
IX6



PER:  
FOR:

### DOM

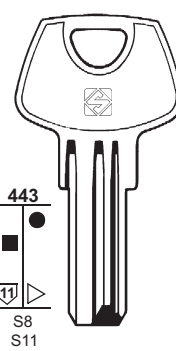
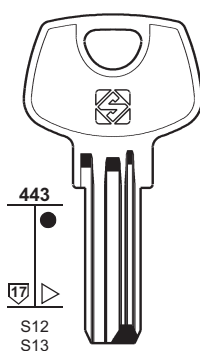
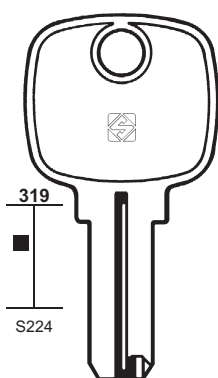
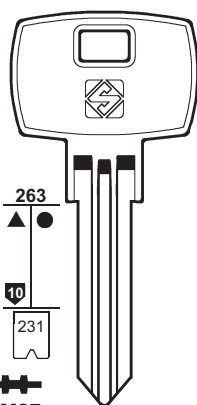

**DM27**  
1H ... 1-4088  
3H ... 1-600

**DM138**

**DM128**

**DM17** **DM17R**  
1H ... 1-4088  
2H ... 1-2088  
3H ... 1-600

**DM21**  
..... 0-1-2-3-4-5

**DM55**  
2Y

**DM58**

ASPA



MOREAUX



ALARM



ALARM



64

PER / FOR

DOM (D)

PER:  
FOR:

DOM

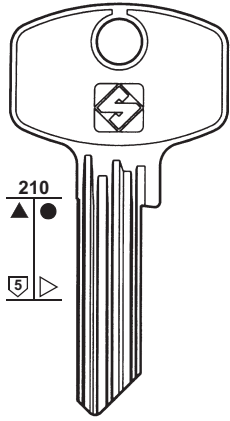

DM40  
L



DM44  
M



DM18R  
C



DM42  
D



DM29  
P



DM43  
U



DM40R  
L



DM44R  
M



DM18  
C



DM42R  
D



DM29R  
P



DM43R  
U



DM67



DM50



DM67R



DM66



DM68



DM69



DM70



DM74



DM60



DM66R



DM68R



DM69R



DM70R



DM74R



DM47  
Q



DM46  
R



DM26  
S



DM47R  
Q



DM46R  
R



DM26R  
S



DM71



DM72



DM73



DM75



DM115



DM71R



DM72R



DM73R



DM75R



DM115R



DM45  
T



DM45R  
T



DM33R



DM12-1



DM12-10



DM12-19



DM12-28



DM12R-12



DM12-37



DM12-46



DM12-2



DM12-11



DM12-20



DM12-29



DM12R-13



DM12-38



DM12-47



DM12-00



DM12-3



DM12-12



DM12-21



DM12-30



DM12R-16



DM12-39



DM12-4



DM12-13



DM12-22



DM12-31



DM12R-19



DM12-40



DM12-5



DM12-14



DM12-23



DM12-32



DM12R-31



DM12-41



DM12R-00



DM12-6



DM12-15



DM12-24



DM12-33



DM12R-32



DM12-42



DM12-7



DM12-16



DM12-25



DM12-34



DM12R-34



DM12-43



DM12-8



DM12-17



DM12-26



DM12-35



DM12R-35



DM12-44



DM12-9



DM12-18



DM12-27



DM12-36



DM12R-36



DM12-45



PER:  
FOR:

# DOM

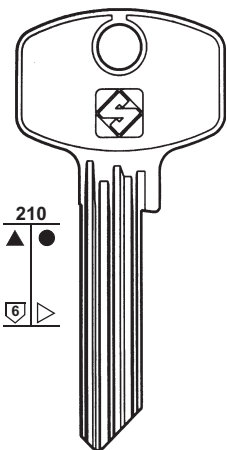

DM86  
L



DM86R  
L



DM77



DM77R



DM76



DM76R



DM87  
M



DM87R  
M



DM78



DM78R



DM88  
C



DM88R  
C



DM108



DM108R



DM79



DM79R



DM89  
D



DM89R  
D



DM80



DM80R



DM90  
P



DM90R  
P



DM84



DM84R



DM94R  
U



DM109



DM109R



DM91  
Q



DM91R  
Q



DM81



DM81R



DM95  
T



DM95R  
T



DM92  
R



DM92R  
R



DM82



DM82R



DM93  
S



DM93R  
S



DM83



DM83R



DM85



DM85R



DM65-00



DM65-1



DM65-10



DM65-19



DM65-28



DM65R-12



DM65-46



DM65-2



DM65-11



DM65-20



DM65-29



DM65R-13



DM65R-00



DM65-3



DM65-12



DM65-21



DM65-30



DM65R-16



DM65-4



DM65-13



DM65-22



DM65-31



DM65R-19



DM65-40



DM65-5



DM65-14



DM65-23



DM65-32



DM65R-31



DM65-41



DM65-6



DM65-15



DM65-24



DM65-33



DM65R-32



DM65-42



DM65-7



DM65-16



DM65-25



DM65-34



DM65R-34



DM65-43



DM65-8



DM65-17



DM65-26



DM65-35



DM65R-35



DM65-44



DM65-9



DM65-18



DM65-27



DM65-36



DM65R-36



DM65-45



# 65

PER / FOR

DOM (D)



66

PER / FOR

**DOMINION** (USA)  
PETERBORO  
+ ARROW (18)

**DOMUS** (I)  
+ CAS-CISMA (40)

**DOMUS** (GR)

PER:  
FOR:

### DOMINION

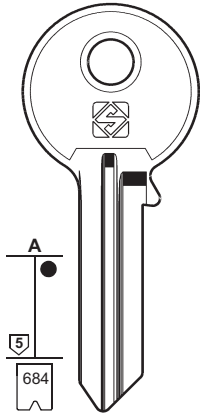

**DO1R**

1-2-3-4-5-6-7-8-9  
PETERBORO

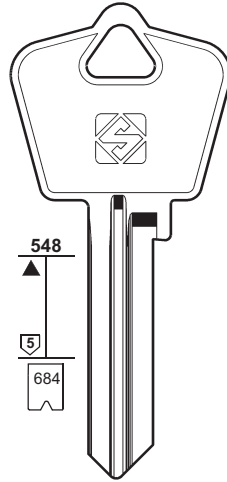

**DO2R**

1-2-3-4-5-6-7-8-9

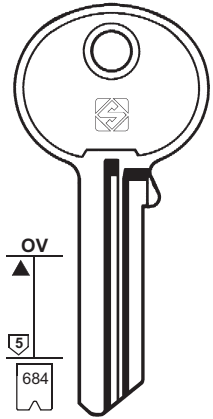

**DO6**

1-2-3-4-5-6-7-8-9

PER:  
FOR:

### DOMINION

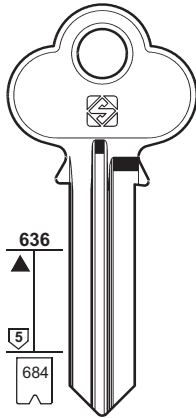

**DO10**

1-2-3-4-5-6-7-8-9

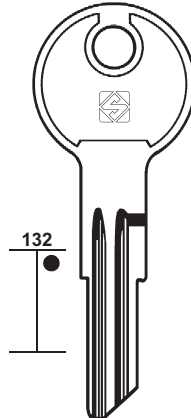

**DO11**

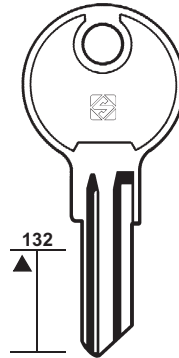

**DO12**

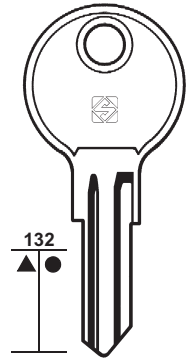

**DO13**



PER:  
FOR:

### DOMUS (I)

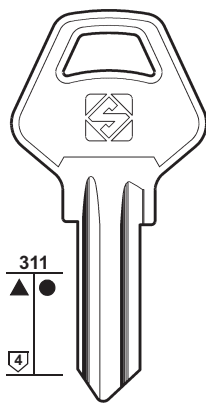

**DS4**

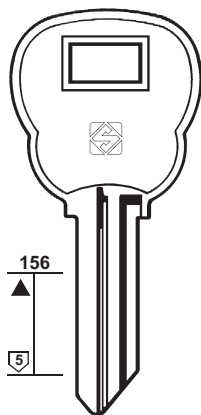

**DS1**



**DS1R**

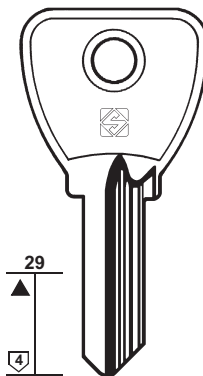

**DS2**

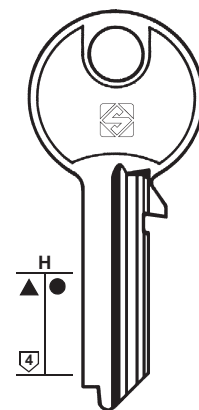

**DS5R**



**DS3R**

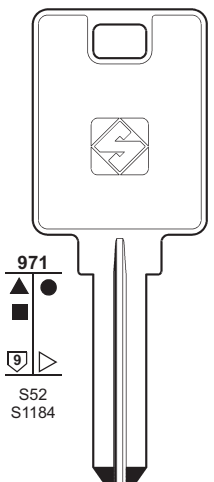







**DS6**

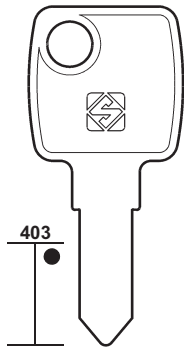
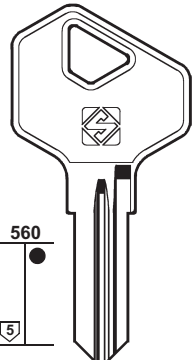
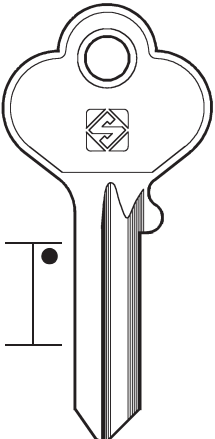
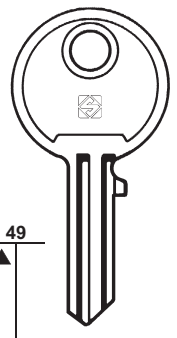









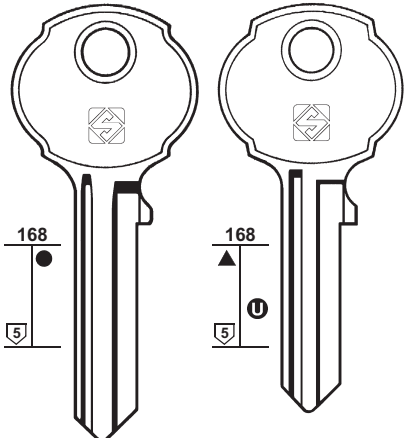
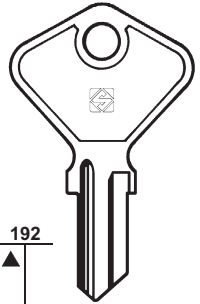
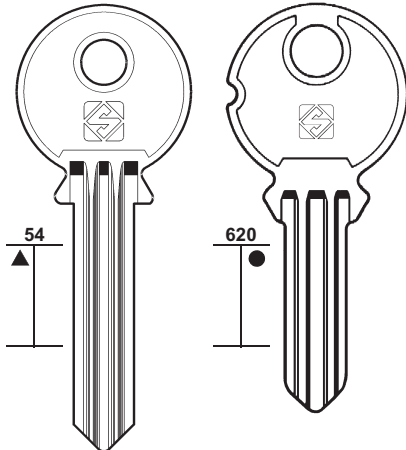

**DS7**











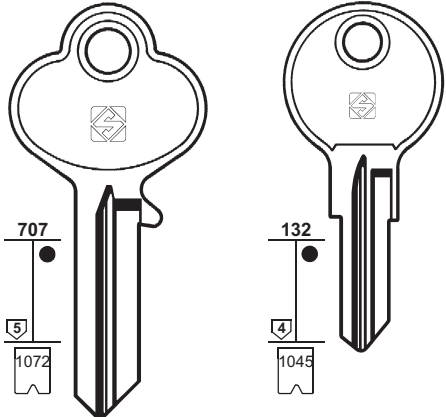
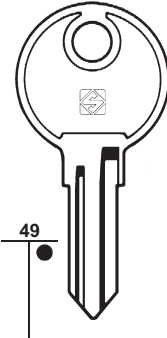
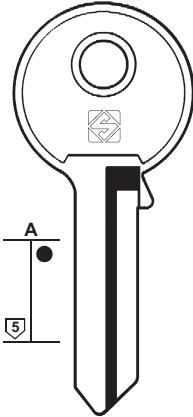



PER: FOR:	DONG HWA	DORIC	DORSET	DOUBLE ARROWS
	 403	 560 5		 49
	 DOW1R	 DRC1	 DRS1R	 DW1 



**67**

PER: FOR:	DOUBLE CIRCLE	DUPLOMATIC	EAG
	 168 5	 192	 54 620
	 DCR1	 DP1	 EA1
	 DCR2	 DP1R	 EA2
	 TRI-CIRCLE		 EA3
			 EA4

PER: FOR:	EAGLE	EAST	ECM
	 707 5 1072	 49	 A 5
	 EG1	 EAS1	 ECM1
	 EG2		 ECM1R
	 EG2R		
	..... 1-2-3-4-5-6-7-8-9-0		
	DNS - HARLOCK - LORI		

PER / FOR
DONG HWA (RC)
DORIC (AUS)
DORMA (D)  WILKA (191)
DORSET (IND) +  KABA (103)
DOUBLE ARROWS (RC)
DOUBLE CIRCLE (RC) TRI-CIRCLE
DOUBLE SAFE (GB)  EURO LOCKS (71)  L & F (116)
DUBOIS (F)  LAS (110)
DUO (USA)  ILLINOIS (96)
DUPLOMATIC (I)
DYES (D)  DOM (62)
EAG (D)
EAGLE (USA) DNS HARLOCK LORI
EAO (D)  DOM (61)
EAST (RC)
EBA (I)  MERONI (124)
ECM (P)



68

PER / FOR

**EFCO** (AUS)

**EFSA** (F)

BABY-CLIP (27)

**EGSA**

TOK-WINKHAUS (170-171)

**EIKO** (RC)

CINA (48)

**EKLA** (HK)

GUARD (90)

**ELCA** (D)

STS  
TESA  
VIRO

**ELDON** (D)

EMKA (69)

**ELEPHANT** (RC)

TRI-CIRCLE (172)

**ELFIN** (I)

CEMA (41)

**ELKO** (CZ)

**ELMO** (USA)

BASCO (28)

**ELP** (RUS)

**ELSA** (I)

GIUSSANI (86)

**ELSET** (F)

CLAUSOR (51)

**ELSI** (I)

INDESIT (96)

**ELVOX** (I)

GIUSSANI (86)

**ELZETT** (H)

TIEFENTHAL  
+ CES (41-42)

**EMGE** (F)

RONIS (147)

**EMHART** (USA)

CORBIN (55)

DOM (62-63)

RONIS (146-147)

PER:  
FOR:

**EFCO**

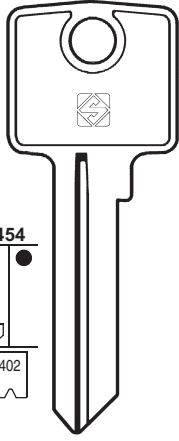

454  
6  
402

.....  
0-1-2-3-4-5-6-7-8-9



- CA EF1R
- CK EF2R
- DA EF3R
- DB EF4R
- DK EF5R
- DM EF6R

**ELCA**

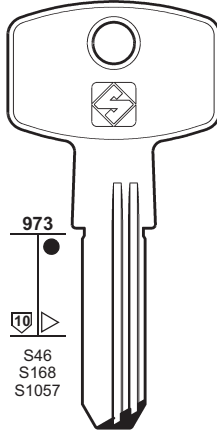

973  
10  
S46  
S168  
S1057



STS - TESA - VIRO

**ELKO**

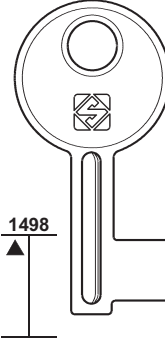

1498



**ELP**

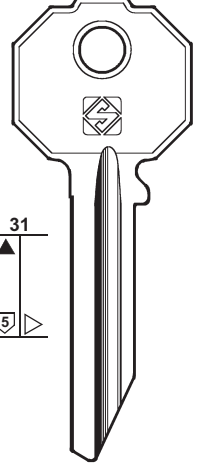

31  
5



PER:  
FOR:

**ELZETT**

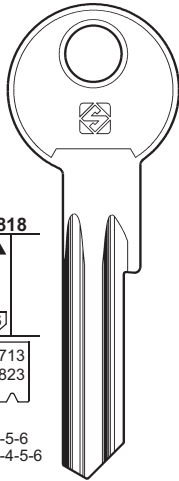

818  
5  
713  
823

.....  
1-2-3-4-5-6  
0-1-2-3-4-5-6

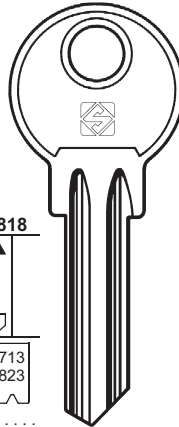

818  
5  
713  
823

.....  
1-2-3-4-5-6  
0-1-2-3-4-5-6

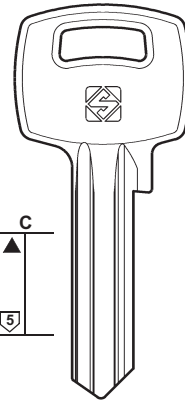

C  
5

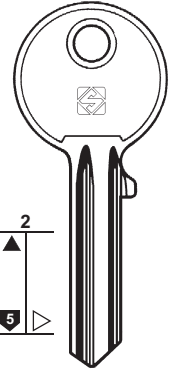

2  
5



PER:  
FOR:

**ELZETT**

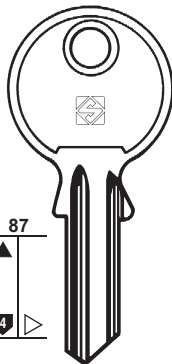

87  
4

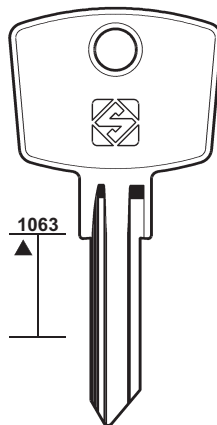

1063

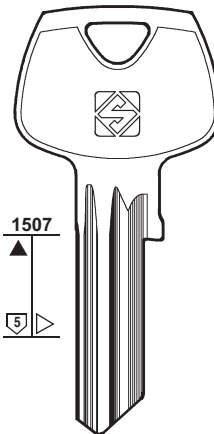



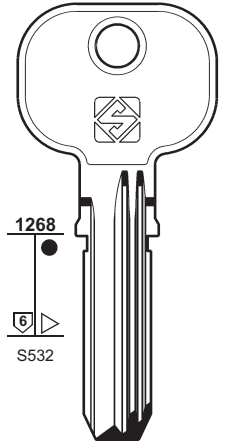





1507  
5

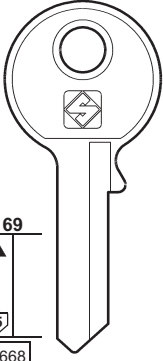
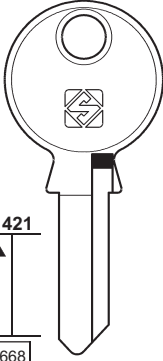

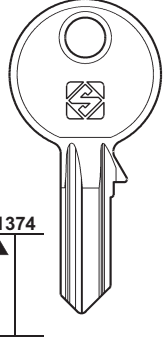
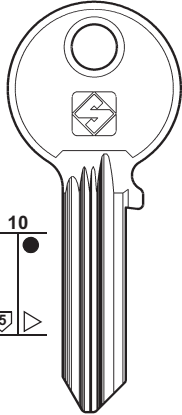
1268  
6  
S532





.....  
0-1-2-3-4

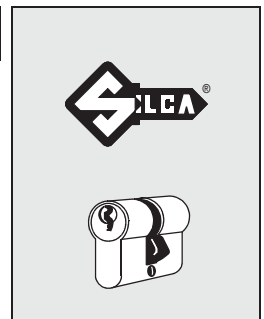



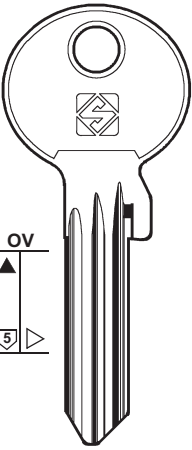
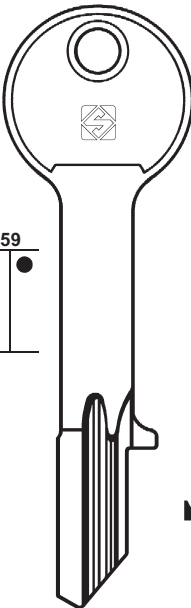
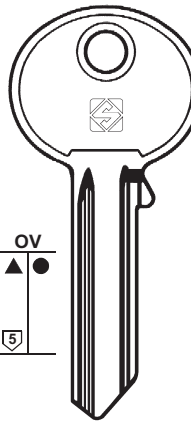
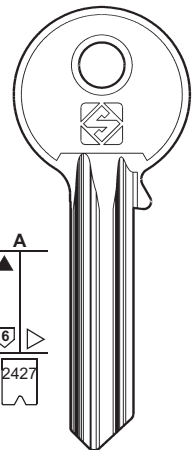



EMKA				EMR
				
69 ▲ 5 668	1421 ▲ 5 668	1421 ▲ 5	1374 ▲ 5	10 ● 5
..... 1-2-3-4	XX ... 091-320			
				
EMK1	EMK5	EMK6R	EMK2	EM4
ELDON - GHE KOVER - RONIS				EM1 EM1R EM2R EM3R EM3
				DOM - GTV - JOWIL TIEFENTHAL

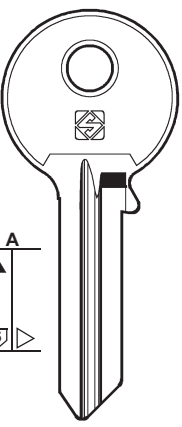
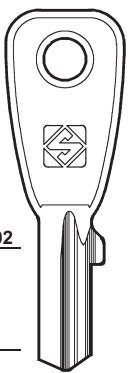
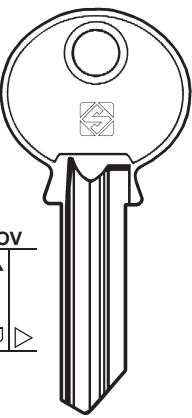
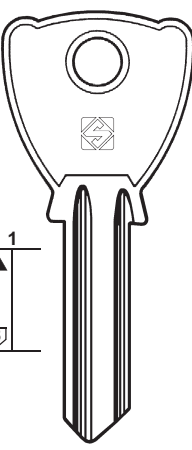

**69**

EMR	ENEL	ERA	
			
OV ▲ 5	59 ●	OV ▲ 5	A ▲ 6 2427
			..... 1-2-3-4-5-6-7-8-9
			
EM11	EN1R	ER1	ER2
GTV - JOWIL			

ERA		ERTEL	ESA
			
A ▲ 5	1402 ▲	OV ▲ 5	1 ▲ 5
			 
ER3R	ER4R	ERT1	ES1R ES1
			NUMIDIA

**PER / FOR**

**EMKA (F)**  
 ELDON  
 GHE  
 KOVER  
 RONIS  
 + EURO LOCKS (70)  
 + FORT (81)  
 + RONIS (146)  
 + TITAN (167)  
 + WILKA (191)

**EMR (D)**  
 DOM  
 GTV  
 JOWIL  
 TIEFENTHAL

**ENAX (F)**  
 TOK-WINKHAUS (171)

**ENEL (I)**

**EPO (J)**  
 SCHLAGE (151)

**EQUIBATIR (F)**  
 RONIS (146)

**ERA (GB)**

**ERICSSON (S)**  
 TEKA (165)

**ERMEX (S)**  
 TEKA (165)

**ERTEL (D)**

**ESA (E)**  
 NUMIDIA

**ESAFE (E)**  
 EZCURRA (73)  
 TESA (165)

**ESCO (D)**  
 CISA (48)  
 CORBIN (53)

**ESLA (GB)**  
 CISA (49)

**ESS (D)**  
 BAB (25)

**ESSENDIA (S)**  
 CISA (48)

**ESZ (D)**  
 JOWIL (100)



70

PER / FOR

ETAS (GB)  
YANEDIS

ETF (F)  
+ BABY CLIP (27)

ETNA (I)  
+ CAS-CISMA (40)

EUREKA (I)  
ITALBLOCK

EURO LOCKS (B)  
FASMA  
L & F  
SCHULTZ  
+ BASTA (28)  
+ CHICAGO (46)  
+ L & F (116-117)

PER: FOR:	ETAS	ETF	ETNA
	 ETA1 YANEDIS	 ETF1	 ET1  ET1R  ET2R

PER: FOR:	EUREKA				EURO LOCKS	
	 EK1	 EK1R	 EK2R	 EK4	 EK3	 EK3R
	ITALBLOCK				 EU17	

PER: FOR:	EURO LOCKS			
	 EU3	 EU12	 EU19	 EU18R
	 EU1R ..... 1201-1400 ..... 45001-48000 ..... 45001-49001 ..... 43001-45000 ..... 48001-49000 ..... 2151-2949 K..... 5272-6291	 EU5R ..... 25001-27000 FASMA	 LF4 60 ... 1-400 90 ... 1-200 92 ... 1-400 ... 1-400 GHM ... 1-155 M ... 1-400 92 ... 401-600 99 ... 1-400 RV ... 1-400 RVM ... 1-400 SP ... 1-400 GS ... 1-400 ... ES1 ... EV1	 LF4R 99 ... 401-600 92 ... 501-700
	 EU11R	 EU1R	 LF6	 LF6R 90 ... 1-200 ... 1-400 91 ... 201-275 GH ... 1-400 SS ... 1-400 91 ... 276-350
	SCHULTZ		L & F	

PER:  
FOR:

## EURO LOCKS

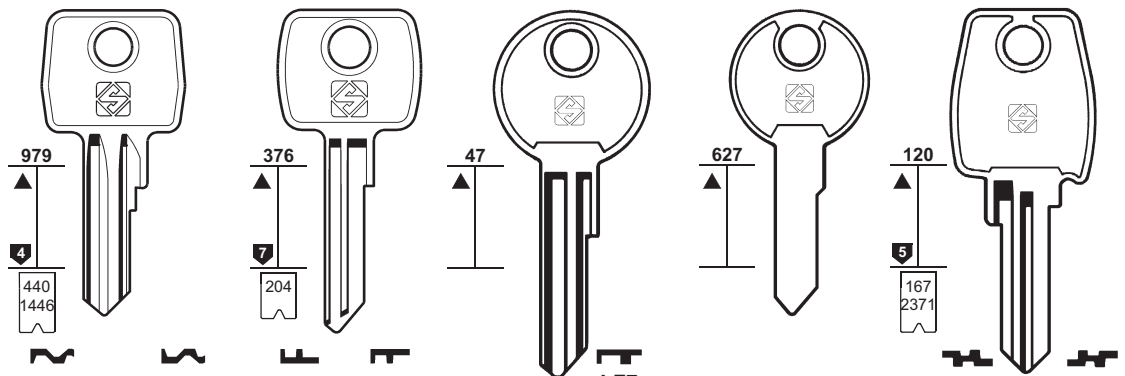

<p><b>EU4</b> ..... E 01234 ..... E 1111-4444 ..... 405-4324 ..... E 405-4324</p> <p><b>EU2</b></p> <p><b>EU7</b></p>	<p><b>EU4R</b> ..... A 01234 ..... A 1111-4444 ..... 458-5124</p> <p><b>EU2R</b></p>	<p><b>LF11</b> 76 ... 1-400 70001-71000 M ... 70001-71000</p> <p><b>LF11R</b></p>	<p><b>LF7</b></p> <p><b>LF8</b>   <b>LF8R</b></p> <p><b>LF29R</b></p>	<p><b>LF16</b>   <b>LF16R</b></p> <p><b>LF2</b>   <b>LF26</b></p> <p>G ... 1001-5000 ..... 31001-32000   77001-77500 ..... 32001-33000   95000-99000 ..... 36001-38000 ..... 38001-38999 ..... 77001-77500 ..... 95000-99000</p>
---	--	---	---	--

L & F

L & F

DOUBLE SAFE



# 71

PER / FOR

### EURO LOCKS (B)

BASI  
DETHLEF  
DOUBLE SAFE  
HOBBY  
KNAUS  
L & F  
TRABER  
VIOMETAL

+ BASTA (28)  
+ CHICAGO (45)  
+ L & F (116-117)

### EURONORM (D)

CORBIN (53)  
 CORNI (55)

### EUROP (F)

SUREX (163)

### EUROSPEC (GB)

### EVERGOOD (RC)

JNF  
MERONI  
SISO

PER:  
FOR:

## EURO LOCKS

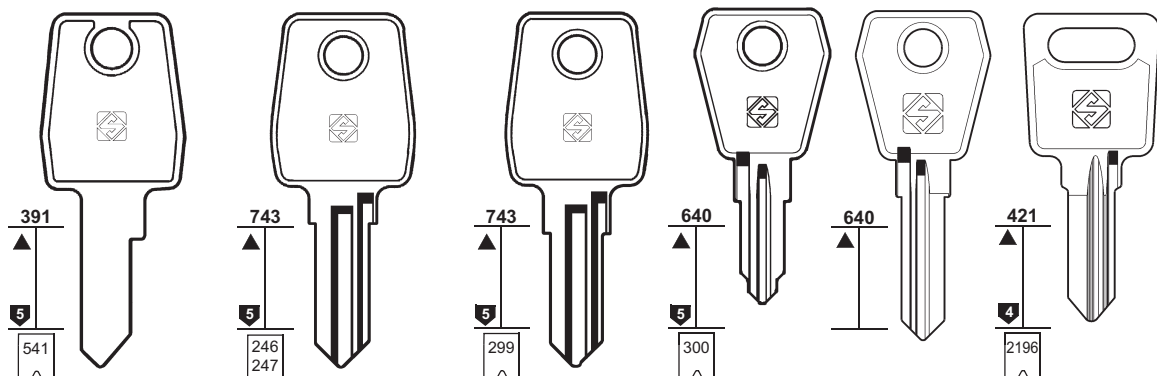

<p><b>LF13</b></p>	<p><b>LF22</b> 93 ... 201-400 ..... 93901-94000</p>	<p><b>LF22R</b></p>	<p><b>LF20</b>   <b>LF20R</b></p> <p>93901-94000</p>	<p><b>LF30R</b> ..... 801-900 ..... 901-1000</p>	<p><b>EU16R</b></p>	<p><b>EU14</b> IF ... 1-2-3-4</p>
<p><b>LF17</b>   <b>LF15R</b></p> <p>L &amp; F</p>	<p><b>EU13R</b> ..... 2001-4000 B ... 001-1000 C ... 001-1000</p>	<p><b>LF23R</b> 93 ... 401-900 ..... 9001-95000 EL ... 9001-9500 EL ... 1-500 ..... 1001-1100</p>	<p><b>EU9</b></p> <p>BASI - L &amp; F VIOMETAL</p>	<p>L &amp; F</p>		

PER:  
FOR:

## EURO LOCKS

## EUROSPEC

## EVERGOOD

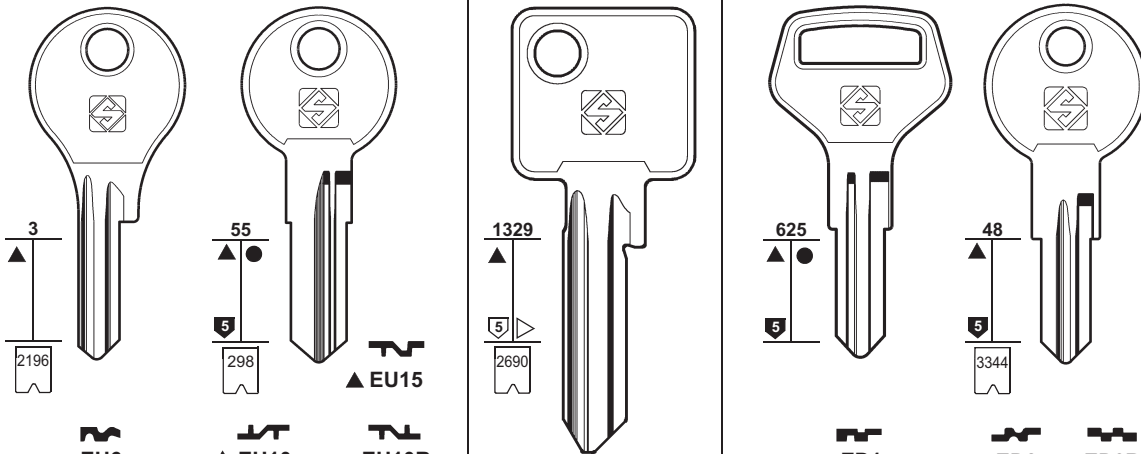

<p><b>EU6</b></p>	<p><b>EU10</b>   <b>EU10R</b> ..... 2001-2200</p>	<p><b>EU15</b></p>	<p><b>EUS1</b> ..... 123456</p>	<p><b>ED1</b></p>	<p><b>ED2</b>   <b>ED3R</b> MERONI ..... 1-2-3</p>
-------------------	---	--------------------	-------------------------------------	-------------------	--

DETHLEF - HOBBY  
KNAUS - TRABER



JNF - SISO



72

PER / FOR

EVO (GB)  
MILA

EVVA (A)  
TRYBA

EXCEL (F)  
+ SIDLEEN (154)

EXPRES (PL)  
LOB (114)

PER: EVO  
FOR:

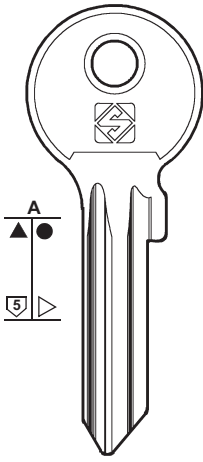

EVO1  
MILA

EVVA

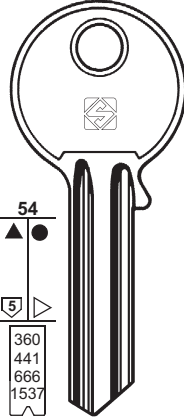

360  
441  
666  
1537  
... A 1000-9999  
... A . 1000-9999  
... A . 1000-9999  
... A . 1000-9999  
... 1234567890  
... 1234567890  
XA ... 40000-59999  
A ... 5600-9999  
... 60001-97000

... C 1000-9999  
... C . 1000-9999  
... C . 1000-9999  
... C . 1000-9999  
... ( ) 1234567890  
C ... 5600-9999  
C ... 60001-97000

EV2  
E  
 EV3  
C  
 EV3R  
2C  
 EV4  
F  
 EV4R  
2F  
 EV5  
Z  
 EV9  
BB  
 EV10  
A  
... Z 1000-9999  
... Z . 1000-9999  
... Z . 1000-9999  
... Z . 1000-9999  
Z ... 5600-9999  
... F 1000-9999  
... F . 1000-9999  
... F . 1000-9999  
F ... 5600-9999

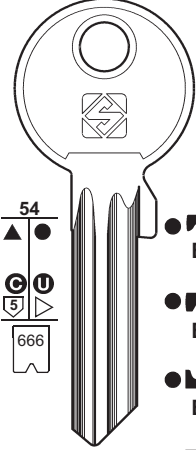

5S ... 40000-59999  
S ... 40000-59999  
S ... 60001-80000  
S ... 98000-99965

EV3X  
C  
 EV3RX  
2C  
 EV4X  
F  
 EV4RX  
2F  
 EV5X  
Z  
 EV9X  
BB  
 EV2X  
E  
 EV10X1  
A  
 EV69X  
S  
 EV64RX

PER: EVVA  
FOR:

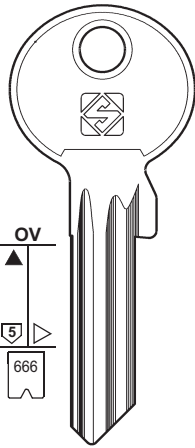

EV10X  
A ... 60001-97000  
TRYBA

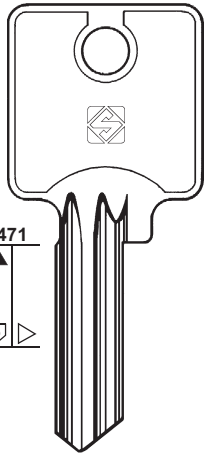

EV11  
C

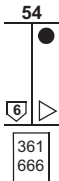
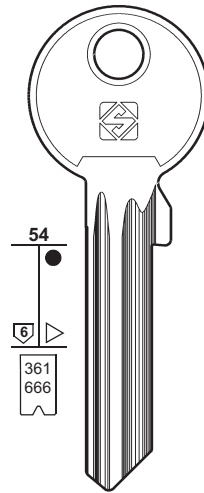

EV12  
A  
6S ...  
40000-59999

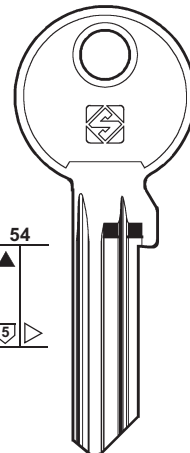

EV81X

EV82X

EV103X-1

EV103X-2

EV103X-3  
 EV103X-8

EV103X-4  
 EV103X-9

EV103X-5  
 EV103X-10

EV103X-6  
 EV103X-11

EV103X-7  
 EV103X-12

PER: EVVA  
FOR:

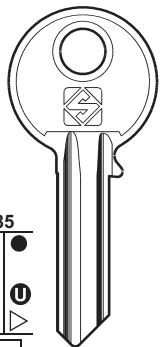

EV8  
K1  
... 2001-2479  
... 1234567890

EV8R  
K0  
... 1001-1479  
... 1234567890

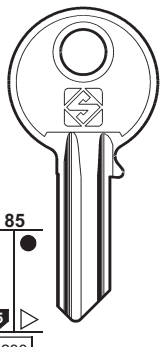

EV7  
K1  
... 4001-4250

EV7R  
K0  
... 3001-3250  
M ... 3001-3250



EV21R  
NM ...  
NM2 ...  
50000-54999

EV22R  
NM ...  
NM2 ...  
55000-59999

EV23R  
NM ...  
NM2 ...  
60000-64999

EV24R  
NM ...  
NM2 ...  
65000-59999

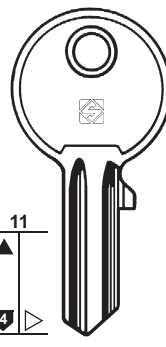

EV6  
K1

EV6R  
K0



EXCEL

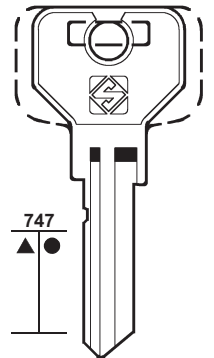

EX1





PER:  
FOR:

# EZCURRA

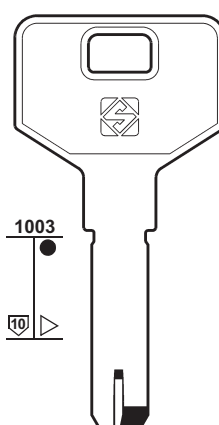
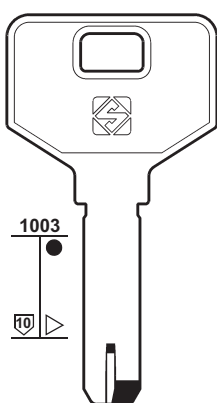
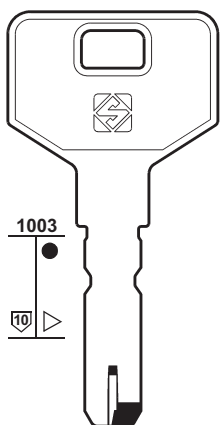
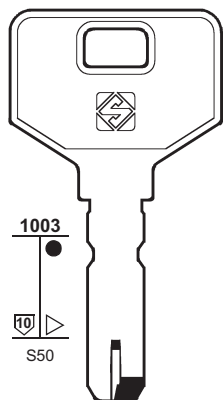

  
**EZ3**  
DS10

  
**EZ3X**  
DS10

  
**EZ6**  
DS15

  
**EZ6X**  
DS15



# 73

PER / FOR

**EZCURRA (E)**  
ESAFE  
JMR  
NAZABAL  
+  SEA (152)

**E-Z-SET (USA)**  
 KWIKSET (108)

PER:  
FOR:

# EZCURRA

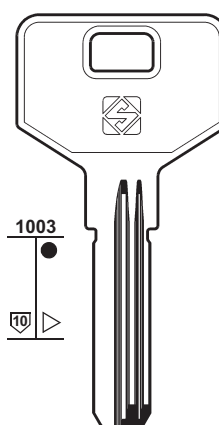
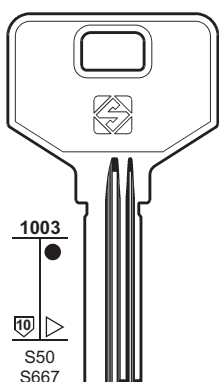
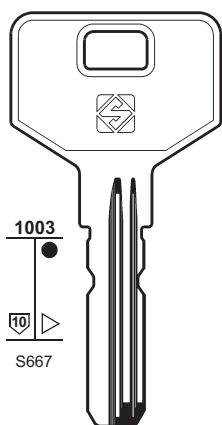
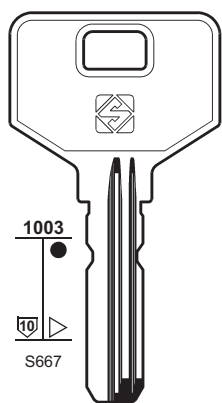

  
**EZ4**  
DS10-E

  
**EZ4X**  
DS10

  
**EZ5**  
DS15-E

  
**EZ5X**  
DS15



PER:  
FOR:

# EZCURRA

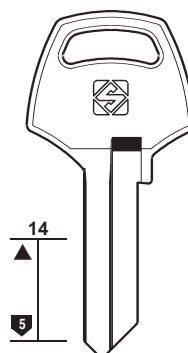
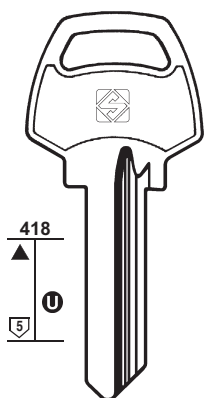
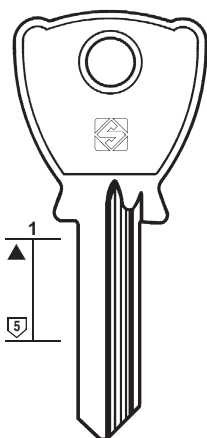

  
**EZ1**

  
**EZ2R**

  
**EZ7**

NAZABAL

ESAFE - JMR



74

PER / FOR

FAB (CZ)  
GUARD  
LOB  
YETI

PER:  
FOR:

FAB

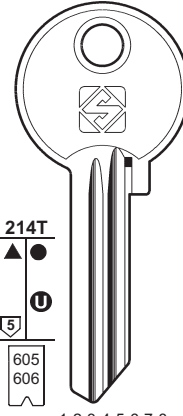
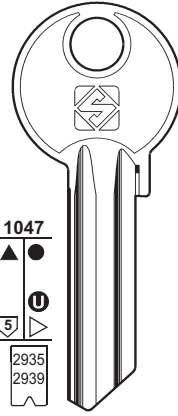
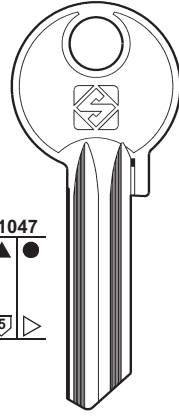
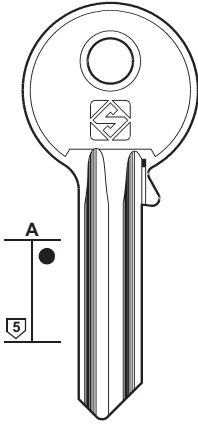

- 11P FB1 FB33
- 10P FB2 FB33R
- FB3R FB42R
- FB4R FB81
- FB5R FB81R



FB26  
40



FB26R  
40 1/2



FB23  
41



FB23R  
41 1/2



FB24  
PP

..... 0123456789ABC  
..... 0123456789



FB9



FB10R  
13



FB7R



FB11R  
15



FB12R  
16



FB8R

GUARD

GUARD

LOB - YETI

PER:  
FOR:

FAB

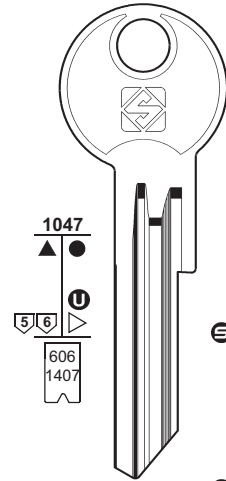

..... 0-1-2-3-4-5-6-7-8  
..... 0-1-2-3-4-5-6-7-8



FB13X



FB13RX  
20



FB14RX  
21



FB15RX  
22



FB16RX  
23



FB62X



FB63X



FB62RX  
030



FB17RX  
24



FB18RX  
26



FB19RX  
30



FB20RX  
32



FB21RX  
10X



FB22RX  
11X



FB25RX  
12X



FB28RX  
14X



FB20X

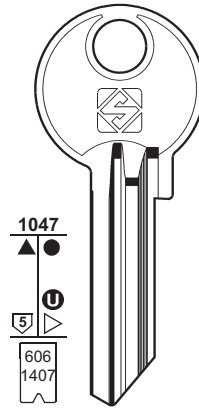

..... 0-1-2-3-4-5-6-7-8  
..... 0-1-2-3-4-5-6-7-8



FB13R  
20



FB14R  
21



FB15R  
22



FB16R  
23



FB17R  
24



FB18R  
26



FB19R  
30



FB20R  
32



FB57R



FB21R  
10X



FB22R  
11X



FB25R  
12X



FB27R



FB28R  
14X

PER:  
FOR:

FAB

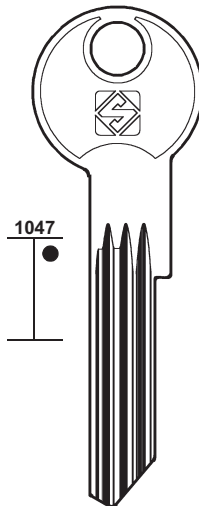

FB64RX  
027

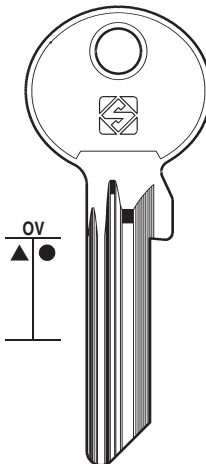

FB64X



FB35R  
K

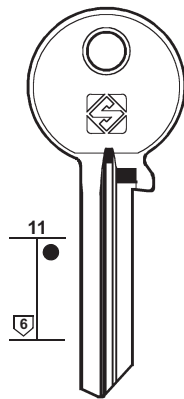

FB65R

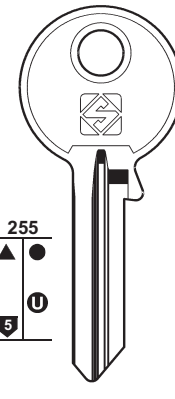

FB34R



FB75R

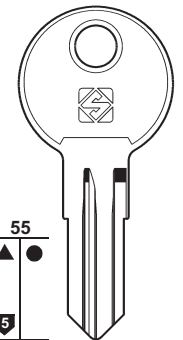

FB36



FB36R



PER:  
FOR:

### FAC

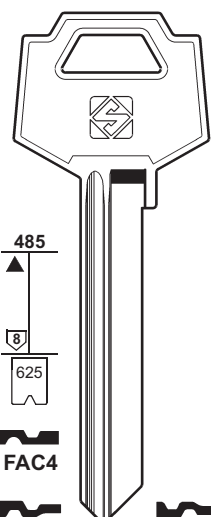
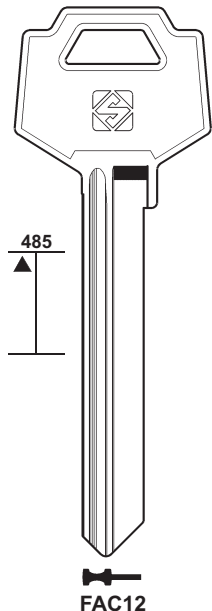
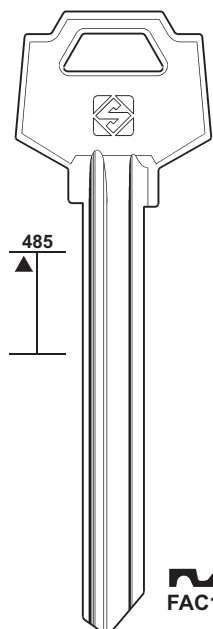
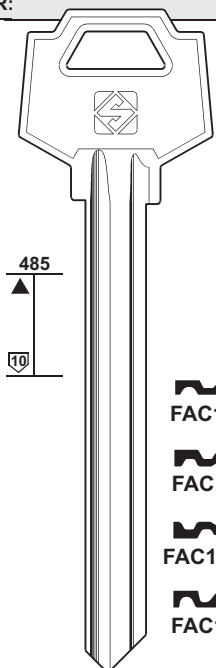

0123456789



# 75

PER / FOR

FAC (E)  
ARREGUI  
INDAUX

PER:  
FOR:

### FAC

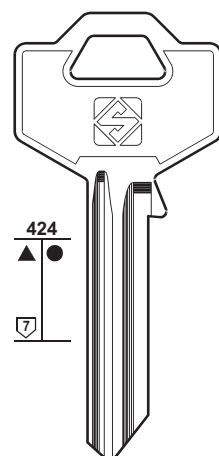
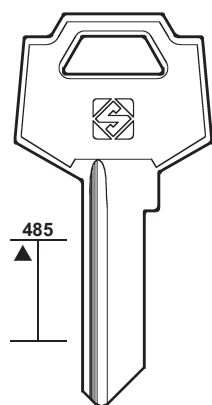
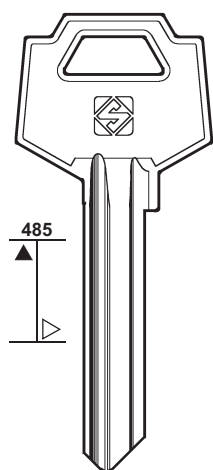
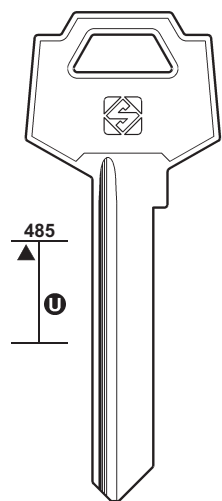

FAC5R  
FAC5

FAC7  
FAC8

PER:  
FOR:

### FAC

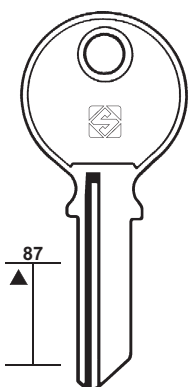

FAC3R  
FAC3

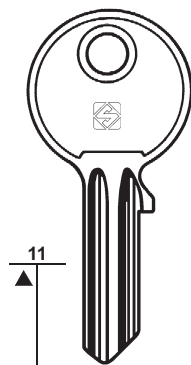

FAC2R  
FAC2

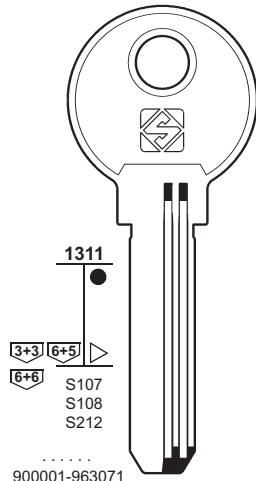

S107  
S108  
S212

900001-963071

FAC15

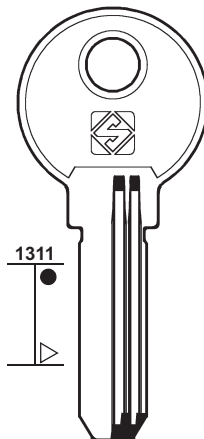

FAC31



76

PER / FOR

FAI (I)  
VIRO  
+ VIRO (186)

FALCON (USA)  
WEISER  
+ BEST (29)

FAMA (I)

FAMA (BR)

FANA (PL)  
+ BRUMME (36)

FARCE (F)  
+ MELSMETAL (122)

FAS (S)

PER:  
FOR:

**FAI**

FAI1R      FAI2      FAI3

VIRO      VIRO

**FALCON**

FN1      FN2      FN4

WEISER

PER:  
FOR:

**FAMA (I)**

FAM1      FAM1R ▲      FAM2R

**FAMA (BR)**

..... 1-2-3-4-5-6-7-8-9-0-A

FAM6      FAM3

PER:  
FOR:

**FAMA (BR)**

..... 1234567890

FAM9      FAM5      FAM8

**FANA**

..... 123456789ABC

FAN1

**FAS**

FS1      FS1R

PER:  
FOR:

### FASEM

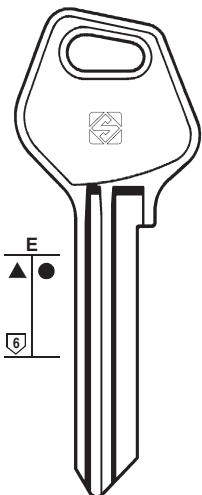

FM7

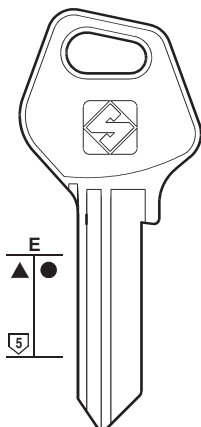

FM6

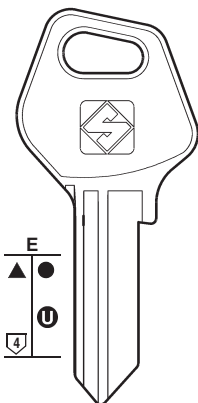

FM1

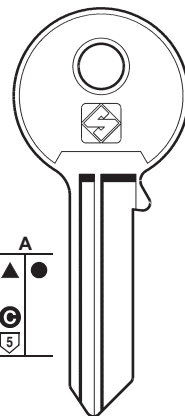

FM090

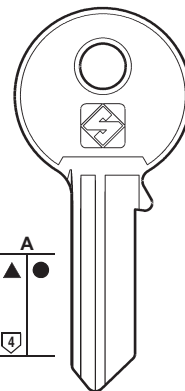

FM2

ILS  
IULIA MAS FED

FPB



# 77

PER / FOR

**FASEM** (I)  
BERETTA  
BV  
FPB  
ILS  
IULIA MAS FED  
JUWEL  
+ BIELLE (30)

PER:  
FOR:

### FASEM

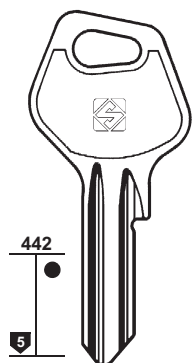

FM5

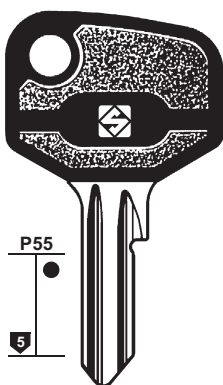

FM5P

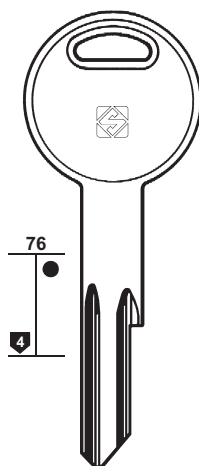

FM8

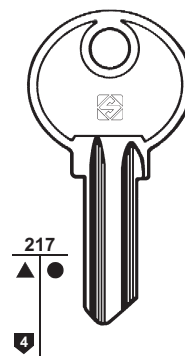

FM4

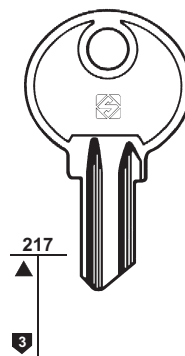

FM4R

FM3 FM3R

BERETTA - BV

JUWEL

JUWEL

**FASMA** (I)  
 EURO LOCKS (71)

**FATTORINI** (I)  
 PREFER (142)

**FAVOUR** (DZ)

**FAYN** (TR)

**FB** (E)  
 AGA (11)

**FBC** (I)  
 GIUSSANI (86)

PER:  
FOR:

### FAVOUR

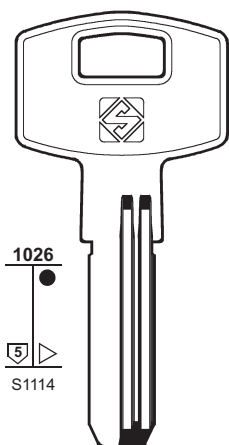

FVR1

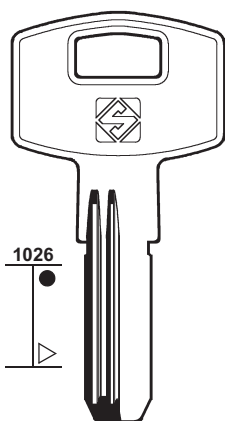

FVR2R

FVR4R

FVR3

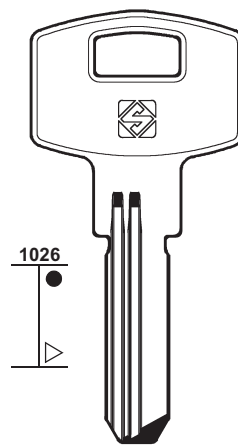

FY1R





78

PER / FOR

FCV (D)

- KFV
- VBH
- + KfV (105)

FEB (I)

- + ALPHA (15)
- + CORBIN (53)
- + JVAL (102)
- + MORI E. (129)
- + P.C. (CORTELLEZZI) (139-140)
- + VIRO (186)

FEDERAL (F)

- + FTH (82-83)
- + JUNKUNC (101)

FEFI (D)

- + CES (42)

FEL (D)

- + SIS (156)

FERCO (F)

- + YALE (195)

FERMABLOCK (I)

- + OLIVA (134)

FERONERIA (RO)

F.F. (I)

- + GUARDIAN

PER:  
FOR:

FCV

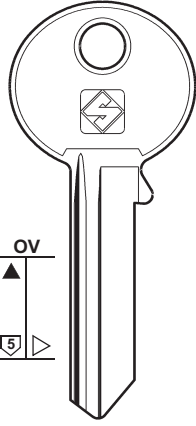

FCV1

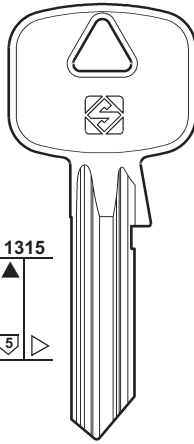

FCV2

KFV

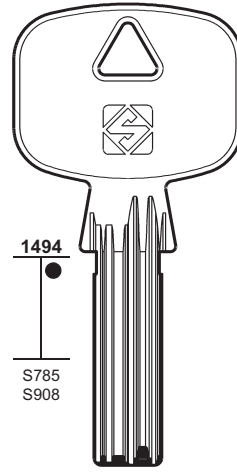

FCV4



KFV - VBH

FEB

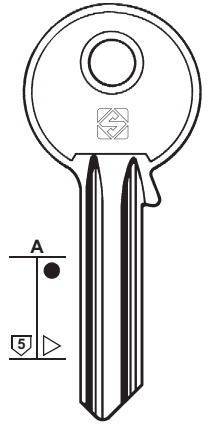

FEB2 FEB2R

PER:  
FOR:

FEB

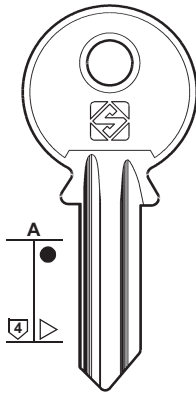

FEB1

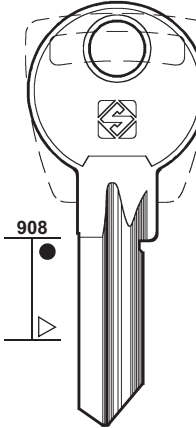

FEB1R



FEB6R

FEDERAL

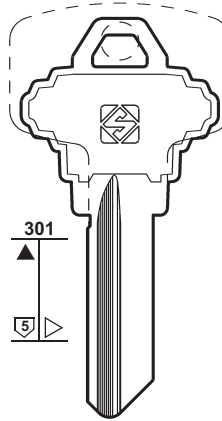

FDR1

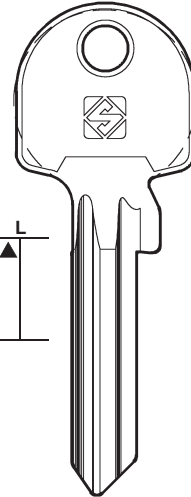

FDR2

FERONERIA

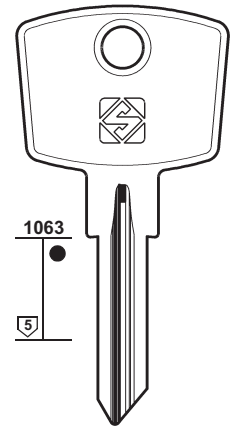

FRN1R

PER:  
FOR:

F.F.

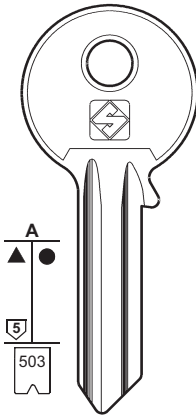

FF1

.....0-1-2-3-4-5-6-7



FF1R

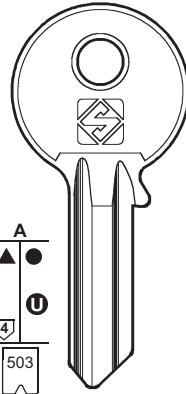

FF2

.....0-1-2-3-4-5-6-7



FF2R

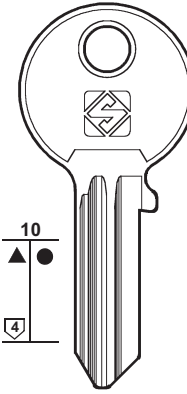

FF15

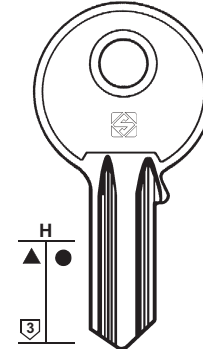

FF3



FF3R

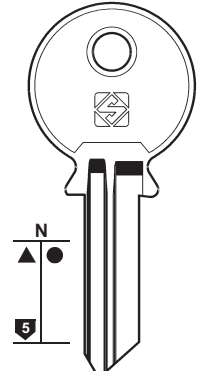

FF14



FF8



FF8R



FF9



FF9R



FF10



FF10R



FF17



FF7



FF7R

GUARDIAN

GUARDIAN

PER:  
FOR:

F.F.

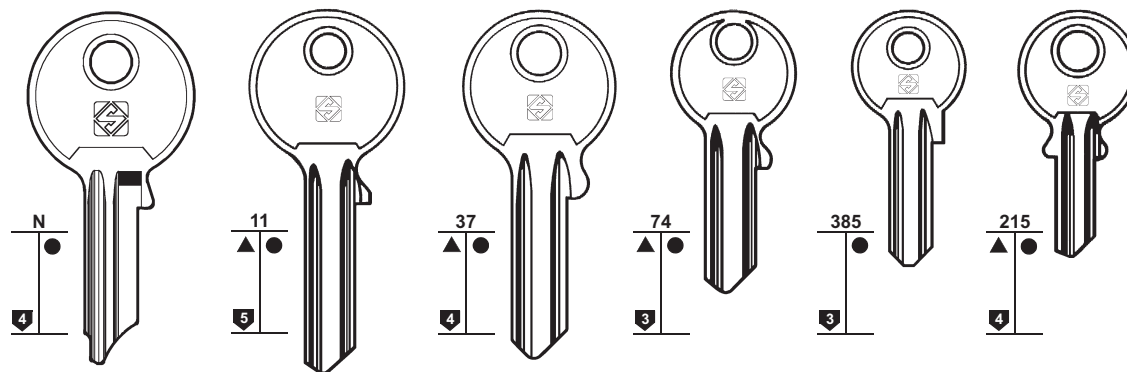

FF18

FF4

● FF4R

FF12

FF12R ▲

● FF5

FF13

● FF6

FF11

FF11R

FF5R

FF13R

FF6R



79

PER / FOR

F.F. (I)

FIAM (I)

+ KESO (105)

FIK (KSA)

+ ZANI (200)

PER:  
FOR:

F.F.

FIAM

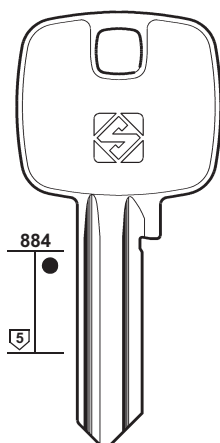

FF16

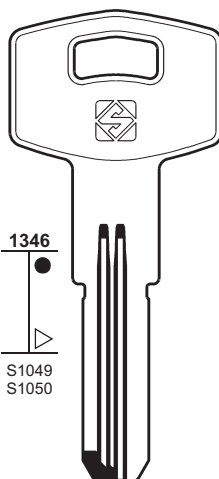

FI3R

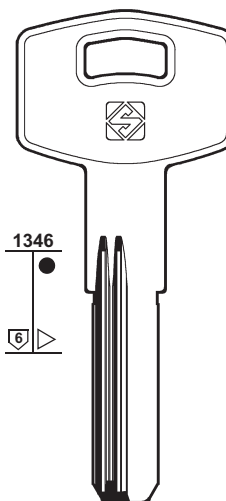

FI4R



PER:  
FOR:

FIAM

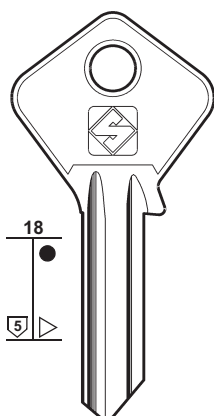

FI234

FI235

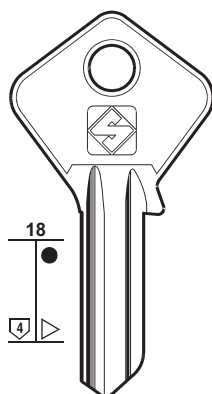

FI232

FI233

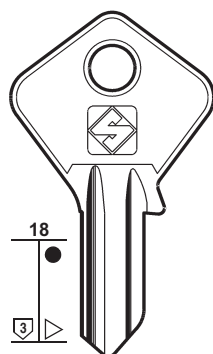

FI1

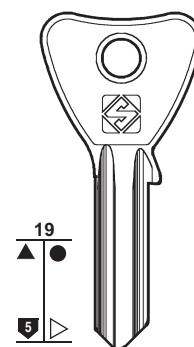

● FI064

FI065



80

PER / FOR

FICHET (F)  
SURFINOR  
TECNOR  
+ TOK-WINKHAUS (171)

FIMANEVSKI (RUS)  
DNEPROPETROVSK  
(59)

FIRMADOOR (AUS)

FIRST (CH)

FIS (I)

PER:  
FOR:

FICHET

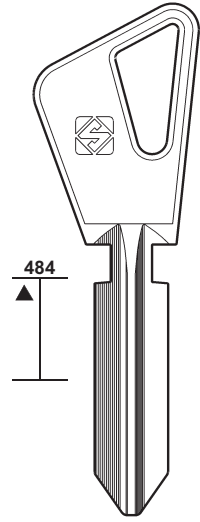

484

FT4



SURFINOR

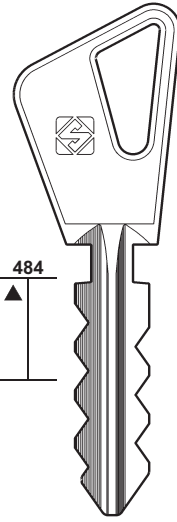

484

FT4C



SURFINOR

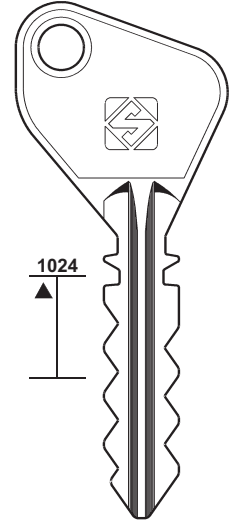

1024

FT5C



PER:  
FOR:

FICHET

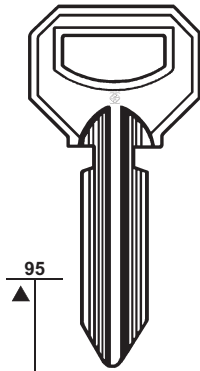

95

FT3



TECNOR

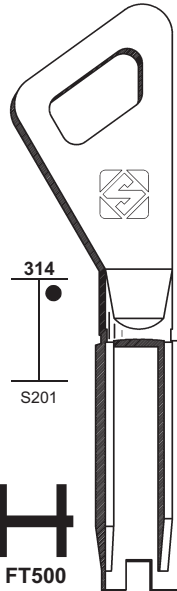

314

S201



FT500

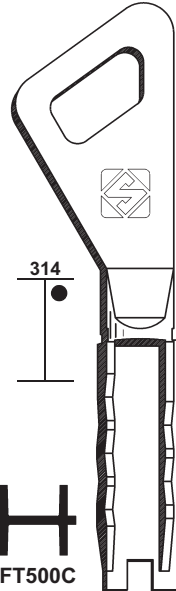

314



FT500C

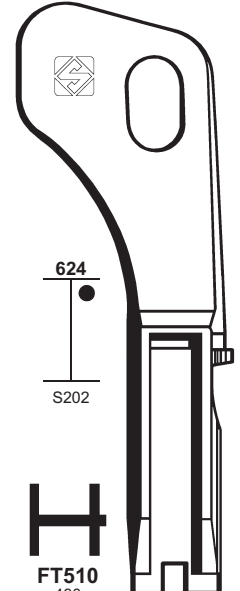

624

S202



FT510  
480

PER:  
FOR: FIRMADOOR

FIRST

FIS

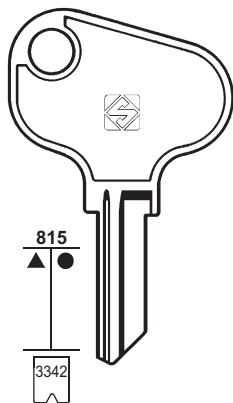

815

3342



FID1  
B... 1-100

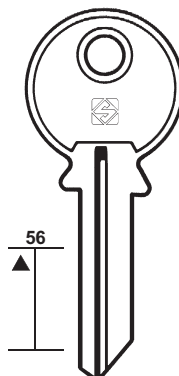

56



FIR1

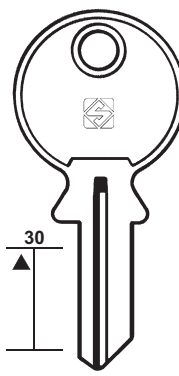

30



FIR3

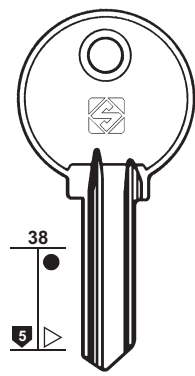

38

5



F1

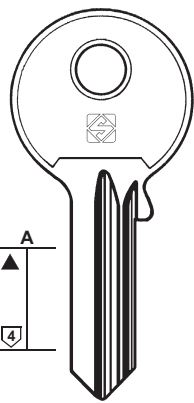

A

4



F2R



PER: FOR:	FIST	FLIK	FLIM	FLORA
				FLOHR - NB NORTHWEST - SUKI

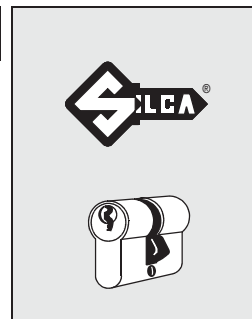

# 81

PER: FOR:	FONDAR	FORT					
	OT	HUDSON	DAD - DECAEUX - EMKA SECURITAL - UTZ			ARFE	DAD
		H . . . . 6001-6250 RM . . . . 7001-7200	. . . . 1-500 . . . . 9001-9500		. . . . 501-600	. . . . 601-700	

PER / FOR
FIST (I)
FLAMBO (D) 👁️ DOM (61)
FLIETHER (D) 👁️ KFV (105)
FLIK (D) + 👁️ GEGE (84)
FLIM (RUS)
FLOHR (D) 👁️ FLORA (81)
FLORA (D) FLOHR NB NORTHWEST SUKI
FO (F) 👁️ CITY (51) 👁️ MONOBLOC (128) 👁️ ZENITH (201)
FONDAR (I) OT
FONTAINE (F) 👁️ CORNI (55) 👁️ RONIS (146) 👁️ VACHETTE (181)
FORINDEX (F) 👁️ RONIS (146-147)
FORT (USA) ARFE DAD DECAEUX EMKA HUDSON SECURITAL UTZ + 👁️ ABUS (9) + 👁️ ARROW (18) + 👁️ CHICAGO (45-46) + 👁️ LAS (110)
FORTIS (E) LBLM
FORTSCHRITT (D) 👁️ DOM (62) 👁️ ZEISS-IKON (201)
FOSAM (I) 👁️ PREFER (143)
FOUR-CIRCLE (RC) 👁️ YETI (198-199)
FPB (I) 👁️ FASEM (77) 👁️ P.C CORTELLEZZI (139)
FRAL (P) 👁️ P.C. CORTELLEZZI (139)
FRANZEN (USA)
FRANZMAR (BR)
FRECOV (D) 👁️ CES (41-42)
FTH (F)

PER: FOR:	FORTIS	FRANZEN	FRANZMAR		FTH
	LBLM				



82

PER / FOR

FTH (F)

- CF
- CIB
- CIBC
- CITY
- DIAMA
- FEDERAL
- GISS
- GPR
- HUNIT
- IFAM
- JL
- NICO
- PICARDIE
- PROBAT
- SAMA
- SUF
- + 👁️ ABUS (8)
- + 👁️ BRUMME (36)
- + 👁️ CAS-CISMA (40)
- + 👁️ GLOBE (88)
- + 👁️ TITAN (168)

PER:  
FOR:

FTH

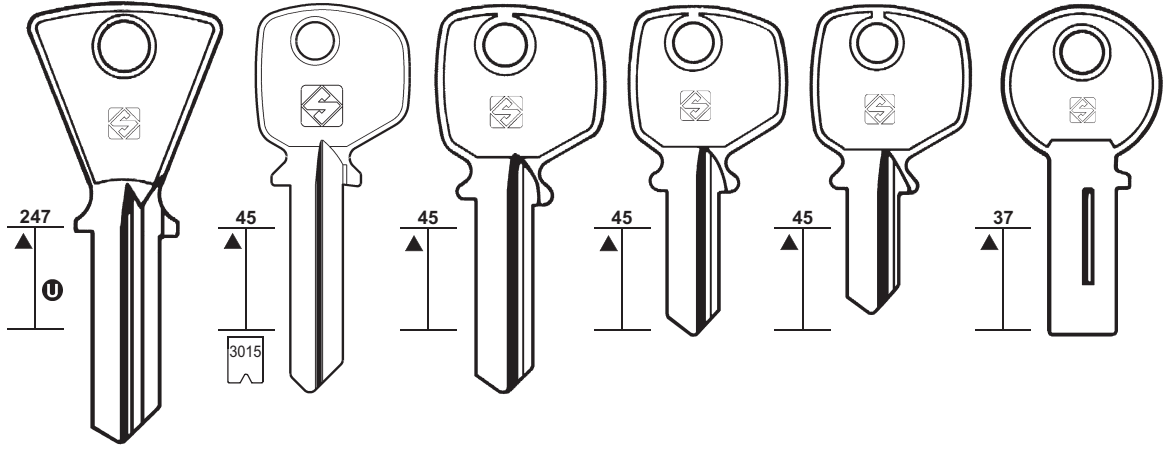

PER:  
FOR:

FTH

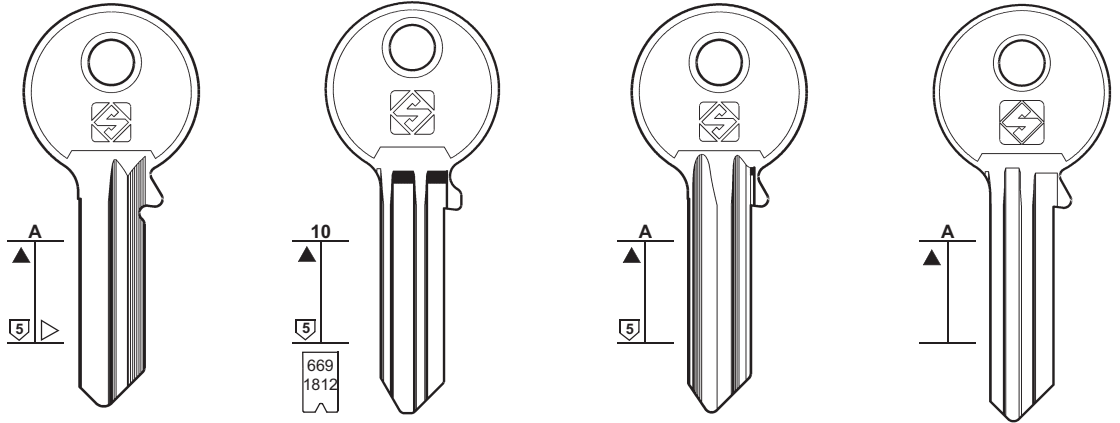

CITY - DIAMA - GISS - GPR  
HUNIT - PICARDIE - SAMA  
CF - CIB - IFAM - JL  
NICO - PROBAT

PER:  
FOR:

FTH

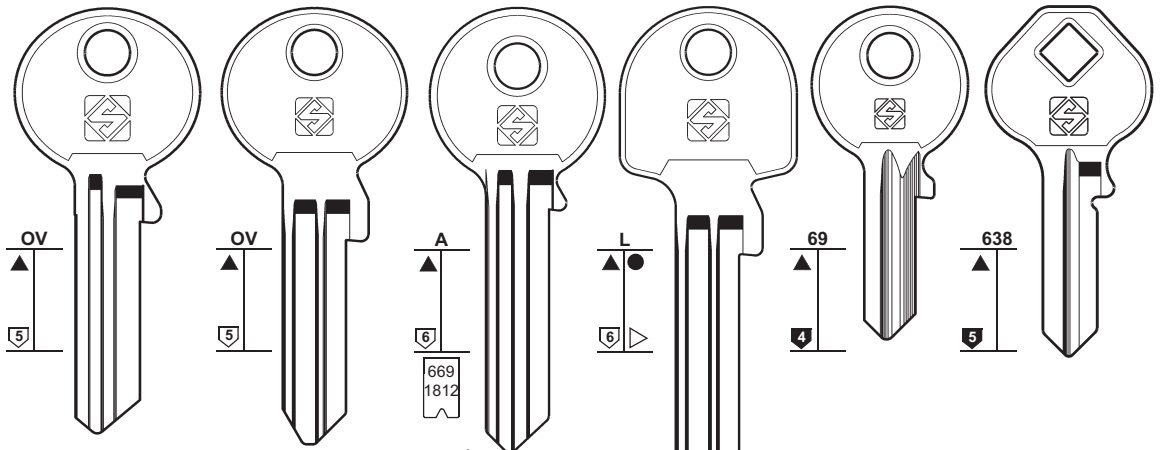

CIBC - CITY - SUF



PER:  
FOR:

### FTH

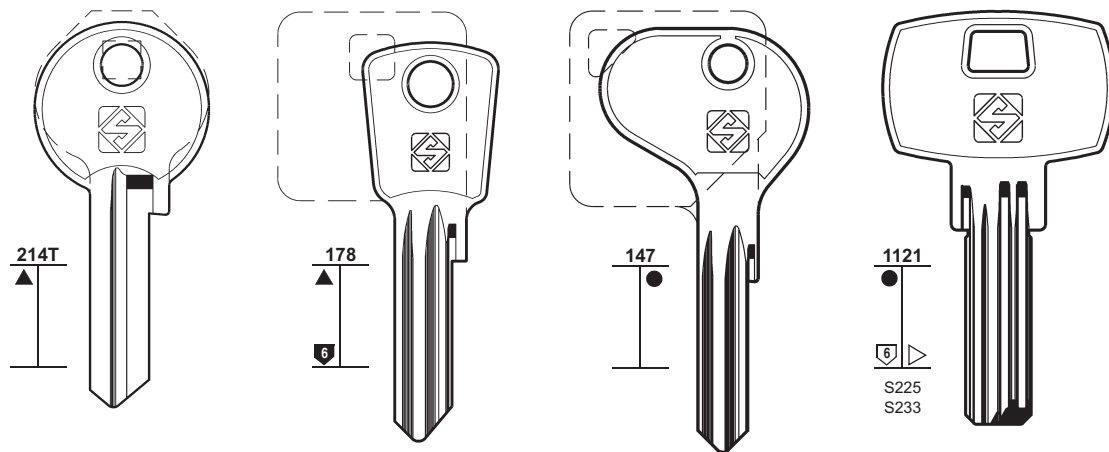

FH23R

FH21R FH22R

FH24R

FH12



# 83

PER / FOR

**FTH (F)**  
 CODEM  
 FEDERAL  
 GOTTA  
 IFAM  
 ITO  
 KARO  
 SP  
 TOVER  
 YALTRES  
 + ABUS (8)  
 + BRUMME (36)  
 + CAS-CISMA (40)  
 + GLOBE (87)  
 + TITAN (167)

**FUHR (D)**  
 CES (42)  
 JOWIL (100)

**FULLEX (F)**  
 GEGE (85)

PER:  
FOR:

### FTH

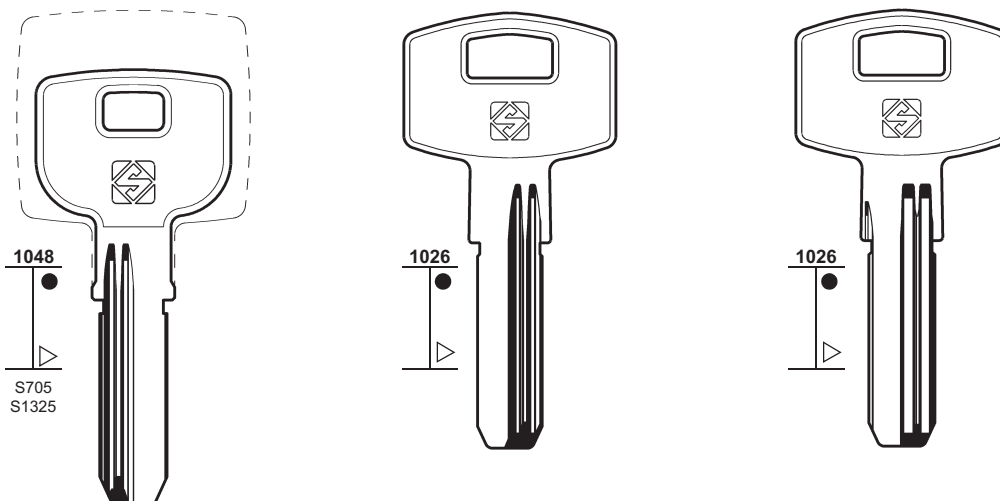

FH17R  
..... 1-2-3-4-5  
IFAM  
KARO

FH37R

FH32

FH33



PER:  
FOR:

### FTH

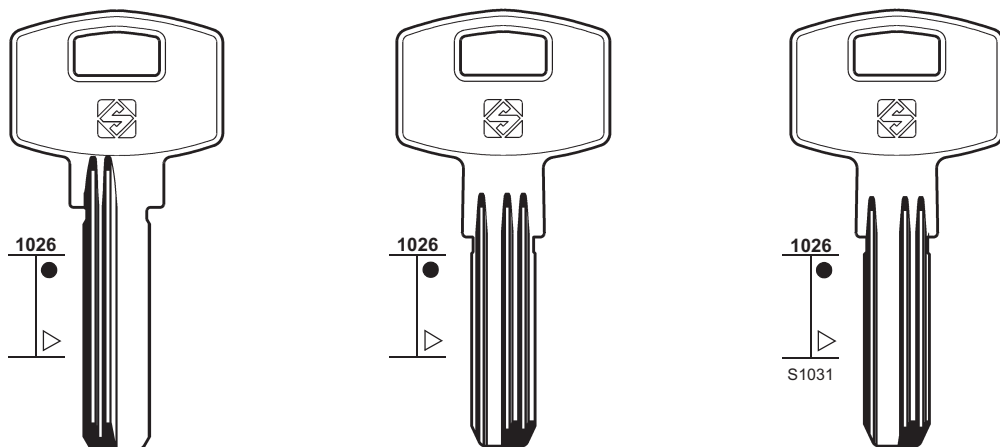

FH34R

FH35

FH36

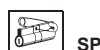
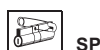



84

PER:  
FOR:

# GABON

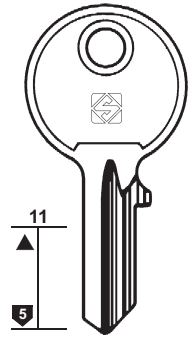
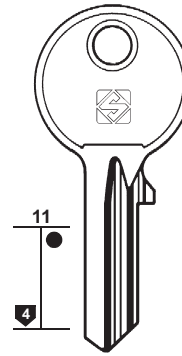
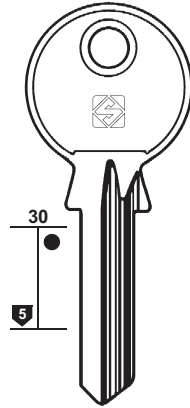
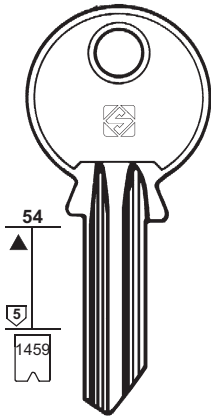

● GB5R



GB5

B... 2000-7700



GB1



GB3



GB2

CHG - DESPREZ - GALLUS  
JOLY - MAXIGARD - PICARDIE  
SOS - SUREX - WINNER

CHG - GALLUS - MAXIGARD  
PICARDIE - SOS - WINNER

PER / FOR

## GABON (F)

CHG  
DESPREZ  
GALLUS  
JOLY  
MAXIGARD  
PICARDIE  
SOS  
SUREX  
WINNER

## GAINSBOROUGH (AUS)

LOCKWOOD (115)  
TESA (165)

## GALLUS (F)

GABON (84)

## GARI (E)

AGA (10)

## GARRISON (GB)

MUL.TLOCK  
(130-131)

## GB (F)

## GBS (D)

## GEA (I)

## GEBA (D)

+ BKS (30)

## GEBRO (D)

CORONA (55)

## GEFI (D)

CISA (48)

## GEGE (A)

ABUS  
FLIK  
FULLEX  
GLOSTAL  
GRUNDMANN  
HÖHRMANN  
PEROHAUS  
TZAFRER  
+ ABUS (6)

PER:  
FOR:

## GB

## GBS

## GEA

## GEBA

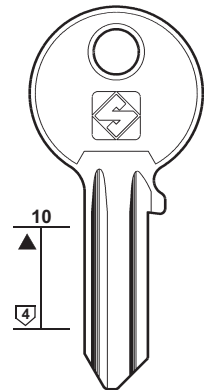
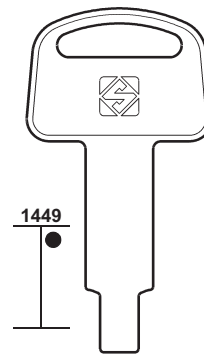
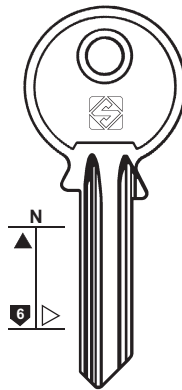
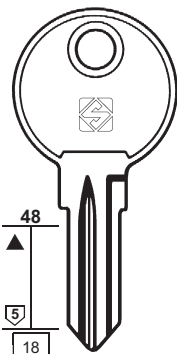

K18

W...



K18R

Z...



K110

Y...



K110R

C...

1-224



WK3



GEA4



GBA1

PER:  
FOR:

# GEGE

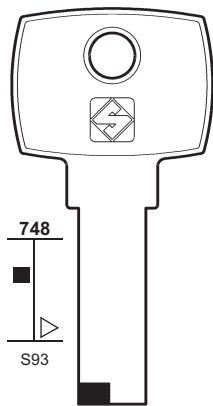

Z...  
101-120

GE57

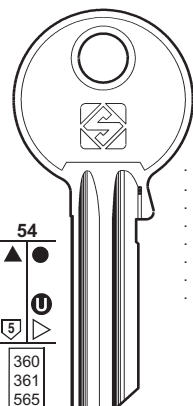

GE1

FULLEX  
GLOSTAL  
GRUNDMANN  
HÖHRMANN  
PEROHAUS

..... 000000-210079

..... (.) 1234567890

..... ( ) 1234567890

..... 1234567890ABCDEF

..... 1234567890ABCDEF

..... (.) 1234567890ABCDEF

..... 5000001-5067680

..... 5000001-545303



▲ GE4



GE4R



GE8R



● GE119



GE34



●▲ GE7R



GE9

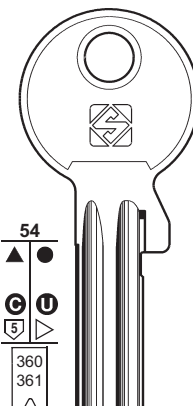

..... 5000001-545303

..... (.)

1-2-3-4-5-6-7-8-9-0

GE1X



▲● GE52X



● GE119X



● GE4RX



● GE7RX



● GE34X



● GE4X



● GE1RX

ABUS - FLIK - TZAFRER

PER:  
FOR:

### GEGE

**GE32**  
471  
5

**GE106**  
68  
6  
420  
674  
1.....  
500001-735807

**GE106XL**  
L  
6  
420  
674  
1.....  
500001-735807

**GE3** **GE3R**  
85  
5  
362  
363  
364  
515  
824  
..... U 1-14518  
..... 10000-16539  
..... 1234567  
..... 1234567890

**GE2** **GE2R**  
85  
4  
235  
362  
E... 00-576  
... T 1-1750  
X... 1001-1875

**GE118**  
2  
5

PEROHAUS LABOFA



# 85

PER / FOR

**GEGE (A)**  
LABOFA  
PEROHAUS  
+ ABUS (7)

**GEM (USA)**  
CHICAGO (46)

**GENTILI (I)**  
CILA (47)

**GERA (D)**  
+ BUVA (39)  
+ SATURN (151)  
+ STARLET (161)

**GETE (D)**  
CISA (48)

PER:  
FOR:

### GEGE

**GE19R**  
M 6  
Z....  
1246-1490

**GE20**  
M 7  
Z....  
1491-1735

**GE21R**  
M 9  
Z....  
1736-1980

**GE22**  
M 10  
Z....  
1981-2222

**GE24**  
M 29  
Z....  
13743-14894

**GE25**  
M 30  
Z....  
14895-16046

**GE26**  
M 31  
Z....  
16047-17198

**GE27**  
M 32  
Z....  
17199-18350

**GE28**  
M 33  
Z....  
18351-19502

**GE29**  
M 34  
Z....  
19503-20654

**GE30**  
M 35  
Z....  
20655-21806

**GE31**  
M 36  
Z....  
21807-22958

**GE3R** **GE3R**  
85  
5  
362  
363  
364  
515  
824

**GE17** **GE16R**

**GE15** **GE15R**

**GE14**

**GE24R**  
M 20  
Z....  
3375-4526

**GE25R**  
M 21  
Z....  
4527-5678

**GE30R**  
M 26  
Z....  
10287-11438

**GE31R**  
M 27  
Z....  
11439-12590

**GE26R**  
M 22  
Z....  
5679-6830

**GE27R**  
M 23  
Z....  
6831-7982

**GE28R**  
M 24  
Z....  
7983-9134

**GE29R**  
M 25  
Z....  
9135-10286

**GE19R**  
453

**GE26**  
167

**GE26R**  
167

825  
A...  
901-987

236

PER:  
FOR:

### GERA

**GR1R**  
OV  
6  
574  
1410  
2217  
1-2-3-4-5-6-7-8-9  
..... 1-2-3-4-5-6-7  
N..... 1-28800

**GR2R**  
857  
5

**GR3**  
908  
5  
PZ6900

**GR4**  
908  
4  
PZ5900

**GR9-5** **GR9R-3** **GR9-7**

**GR9-8** **GR9-9** **GR9R-1**



86

PER / FOR

**GEVY (GR)**  
MOTTURA  
+ CISA (48)  
+ DELCA (58)  
+ P.C.  
CORTELEZZI (140)

**GEWIRU (D)**  
 DOM (61)

**GEWISS (I)**

**GHE (D)**  
 EMKA (69)  
 LA PORTE (110)

**GHIDINI (I)**  
 ZANETTI A. (200)

**GIESCHE (GB)**  
 CES (42)  
 KFV (105)

**GIMM (F)**  
 RONIS (147)

**GIOBERT (I)**  
OLIVETTI

**GIBBONS (GB)**  
WILLENHALL

**GIP (F)**

**GISS (F)**  
 FTH (82)

**GIUSSANI (I)**  
BRETER  
CAB  
ELSA  
ELVOX  
FBC  
LUME  
METALCASTELLI  
MLP  
OAL  
PLG  
SIMECA  
+ BRETER (34)  
+ TITAN (167)

PER: **GEVY**

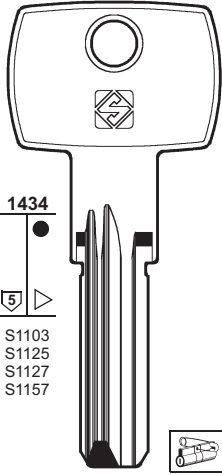

1434

5

S1103  
S1125  
S1127  
S1157



**GVY1R**

..... 600001-613040  
..... 900001-902780

MOTTURA

PER: **GEWISS**

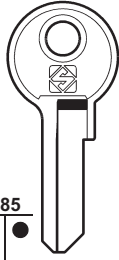

385

3



**GWS1**



PER: **GIOBERT**

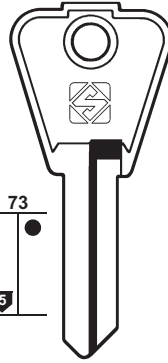

73

5



**GT4**



**GT4R**

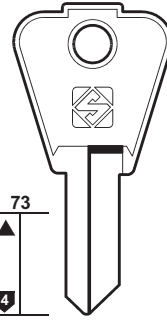

73

4



**CM2**



**CM2R**

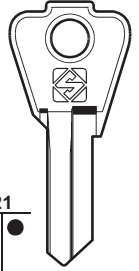

21

5



**GT1**



**GT1R**



PER: **GIOBERT**

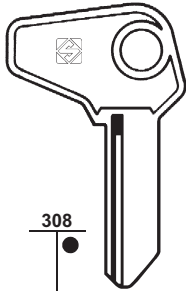

308

5



**GT3**

**E**



**GT3R**

**F**

OLIVETTI



PER: **GIBBONS**

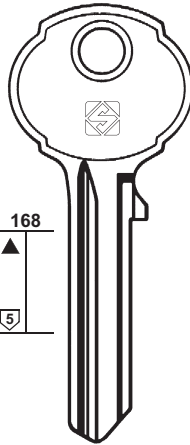

168

5



**GN1**

WILLENHALL

PER: **GIP**

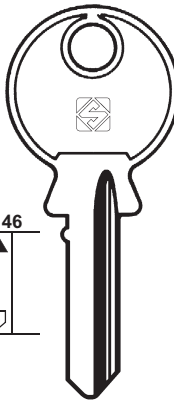

46

5



**GP1**

PER: **GIUSSANI**

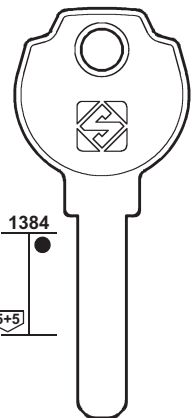

1384

5+5



**GS17**



PER: **GIUSSANI**

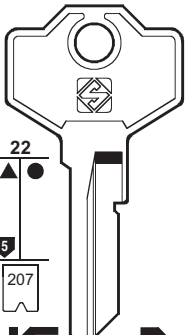

22

5

207



**GS1**



**GS4R**

E...9001-9741



**SM1R**



**GS9**

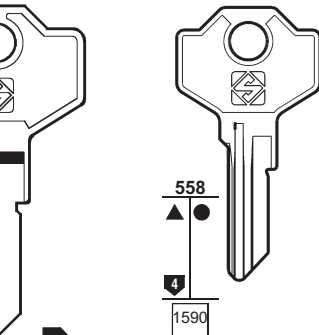

558

4

1590



**GS1R**



**GS4**

E...3001-3480



**SM1**

..... 9001-9741  
G... 3001-3480  
..... 3001-3480  
G...9001-9741  
G...0-480

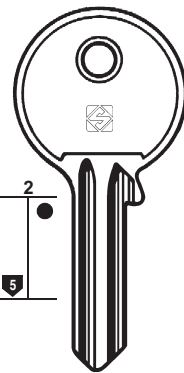

2

5



**GS3**



**GS3R**

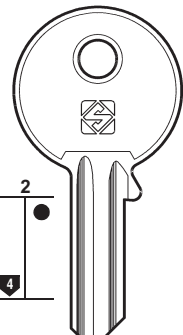
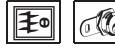

2

4



**GS2**



**GS2R**

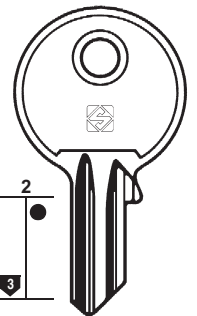

2

3



**GS10**



**GS10R**



CAB - ELSA - ELVOX  
PLG - SIMECA

OAL - LUME

BRETER

FBC - MLP

METALCASTELLI

PER:  
FOR:

# GIUSSANI

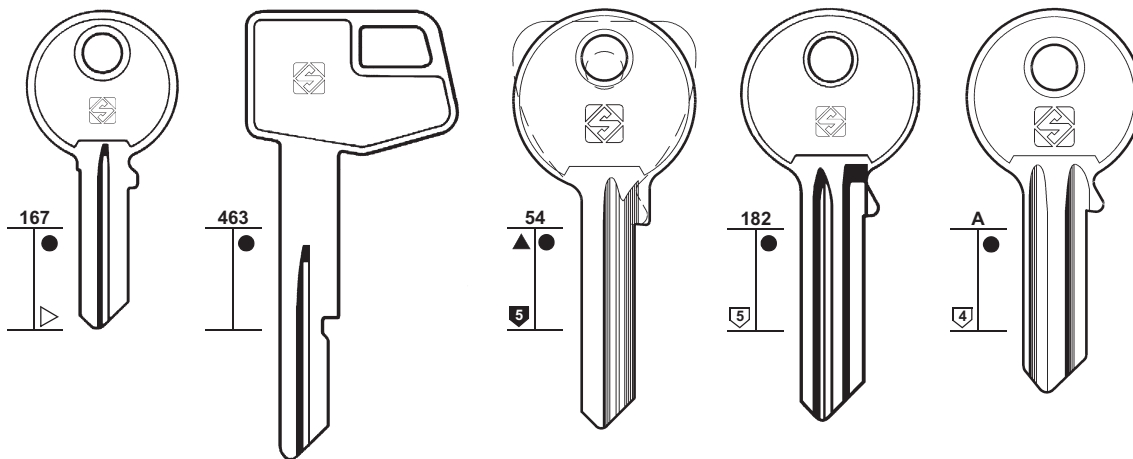

**GS12R**

**GS11R**

**GS5**

**GS6**

**GS8**

**GS7**



MLP



BANKA



PASTORE



# 87

PER / FOR

**GIUSSANI (I)**  
 BANKA  
 MLP  
 PASTORE  
 + BRETER (34)  
 + TITAN (167)

**GLAZIEV (RUS)**

**GLOBAL (GB)**

**GLOBE (RC)**  
 ANLO  
 GOLD-DOOR  
 LARK  
 LUCO  
 MIAN-FORCE  
 SOF  
 WHALE  
 + GOLD DOOR (89)  
 + HILLO (93)

PER:  
FOR:

# GLAZIEV

# GLOBAL

# GLOBE

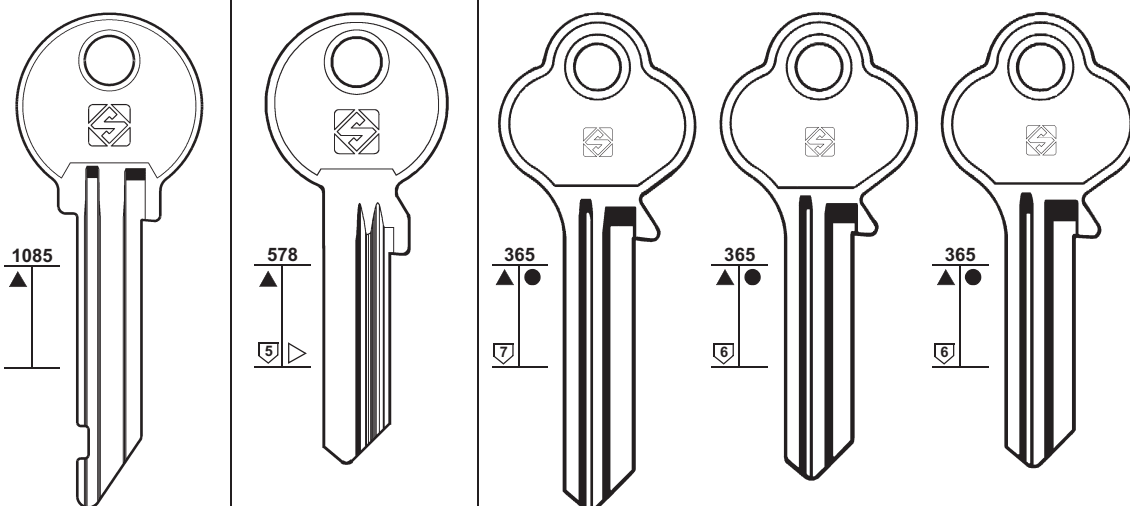

**GLZ1**

**GBL1R**

**GL8**

**GL7**

**GL7R**

**GL6**

**GL6R**



LARK



WHALE

PER:  
FOR:

# GLOBE

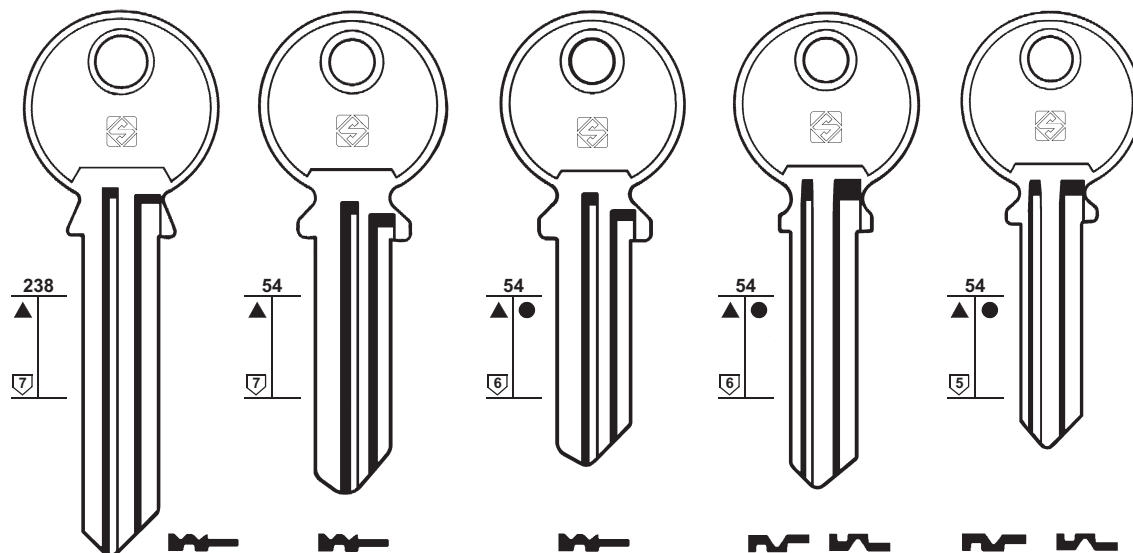

**GL11R**

**GL12R**

**GL13R**

**GL9**

**GL9R**

**GL10**

**GL10R ●**



MIAN-FORCE



SOF



GOLD-DOOR



ANLO - LUCO



88

PER / FOR

GLOBE (RC)

DOFIN

FTH

GOLD-DOOR

IFAM

SOF

+ GOLD DOOR (89)

+ HILLO (93)

GLOSTAL (D)

+ GEGE (84)

GOAL (J)

+ GSS (90)

PER:  
FOR:

GLOBE

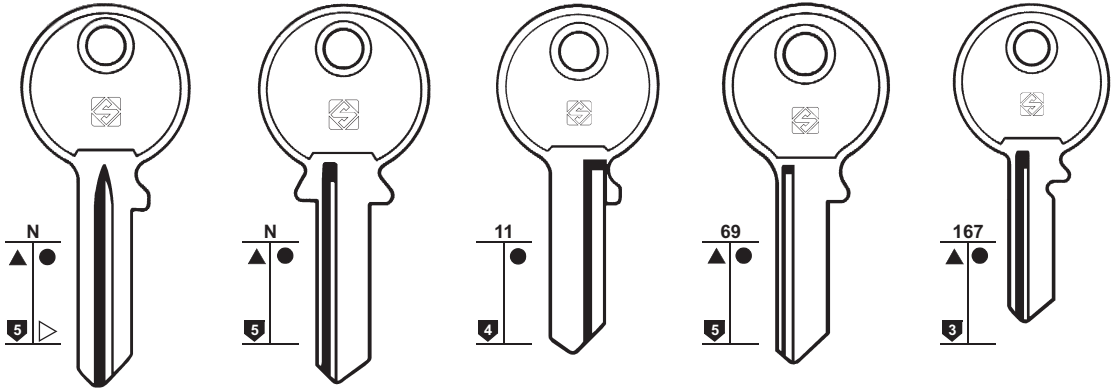

GL4



GL3R



GL5



GL2R



GL4R



GL3



GL5R



GL17R



GL2



DOFIN - FTH  
GOLD DOOR  
SOF



IFAM

PER:  
FOR:

GLOBE

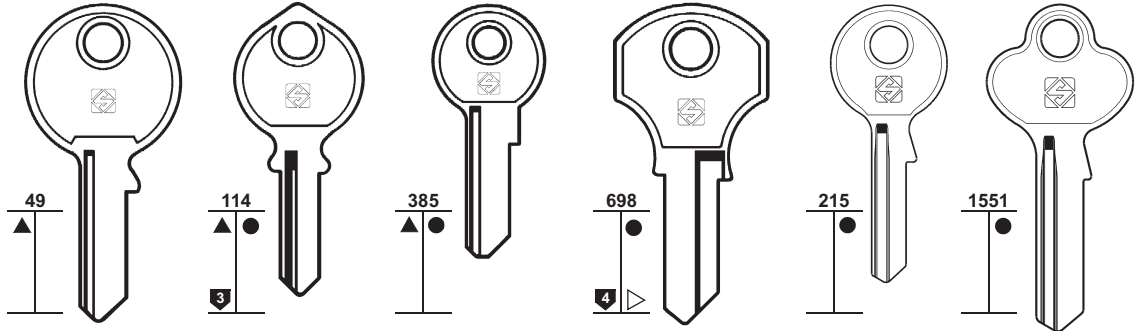

GL18R



GL1R



GL1



GL19R



GL14



GL21R



GL22R



GOLD-DOOR



PER:  
FOR:

GOAL

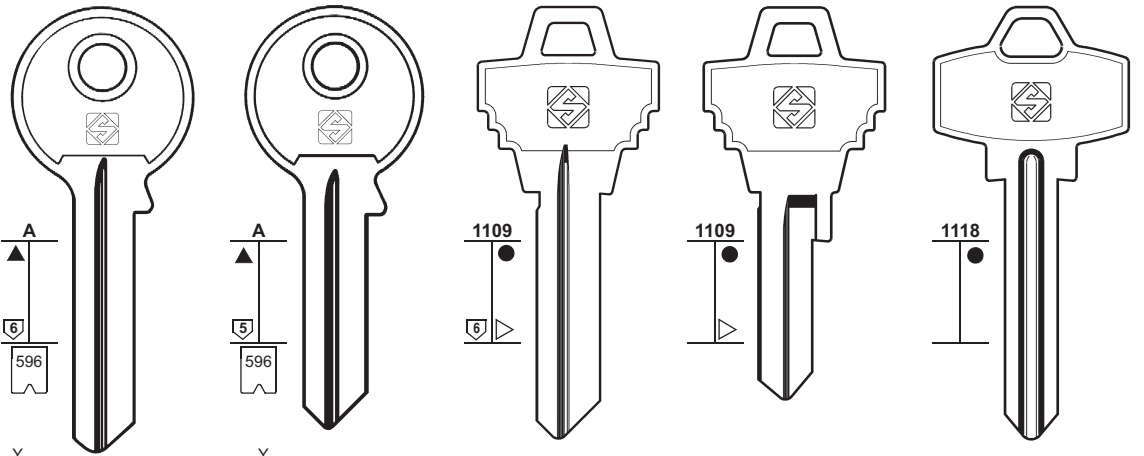

GO2R



GO1R



GO4R



GO3



GO5

Y.....  
1-2-3-4-5-6-7

Y.....  
1-2-3-4-5-6-7



PER: FOR:	GOAL	GODREJ	GOLD
	<p>1378 S547 S731 S884 GO6</p> <p>1378 S548 S877 GO7</p>	<p>GJ3</p>	<p>62 GOD4R</p>



**89**

PER: FOR:	GOLD DOOR	GP	G.R. (GUERVILLE RIQUIER)
	<p>56 GL20 GLOBE</p>	<p>1129 GPI1</p>	<p>717 RIQ10R</p>

- PER / FOR**
- GOAL (J)**  
+ GSS (90)
  - GODREJ (IND)**
  - GOLD (BRA)**
  - GOLD-DOOR (RC)**  
GLOBE  
+ GLOBE (87-88)
  - GOLLOT (F)**  
RONIS (146)
  - GOTTA (D)**  
FTH (82)
  - GÖTZ (D)**  
KFV (105)
  - GP (I)**
  - GPR (F)**  
FTH (82)
  - G.R. (F)**  
(GUERVILLE-RIQUIER)  
DEBEURAIN  
MONDIAL  
SE

PER: FOR:	G.R. (GUERVILLE RIQUIER)	
	<p>53 302 RIQ3 RIQ2</p>	<p>54 302 RIQ8 RIQ7</p>
	<p>52 302 RIQ1 RIQ1R</p>	
	<p>R ..... 1234567890 F ..... 1234567890 G ..... 1234567890</p> <p>MONDIAL</p>	<p>Z ..... 1234567890 T ..... 1234567890 XT ..... 1234567890 Y ..... 1234567890</p> <p>DEBEURAIN - SE</p>



90

PER / FOR

G.R. (F)  
(GUERVILLE-RIQUIER)  
ABUS  
BRICARD  
PERRIER

GRAF (D)  
KfV (105)

GRAYHILL (USA)  
ILLINOIS (96)

GRIFO (RC)

GRUNDMANN (A)  
GEGE (84)

GS (GR)  
STAR (161)

GSA (I)  
CAS-CISMA (40)

GSS (J)  
GOAL

GTV (D)  
JOWIL  
TIEFENTHAL  
+ CISA (48)  
+ EMR (69)  
+ JOWIL (100)

GUARD (HK) (CZ)  
ABUS  
EKLA  
ROYAL  
+ ABUS (8)  
+ FAB (74)

PER:  
FOR:

G.R. (GUERVILLE RIQUIER)

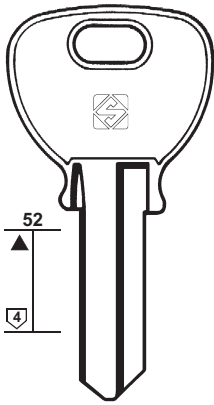

RIQ5



RIQ5R

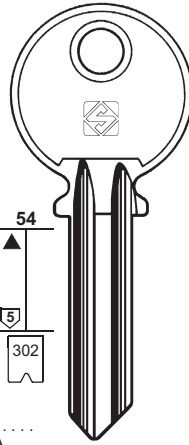

RIQ4



RIQ4R

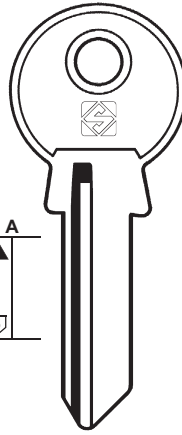

RIQ9



RIQ9R

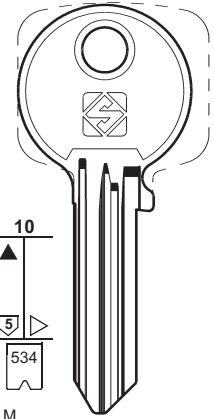

RIQ11



RIQ11R

.....  
A.....  
1-2-3-4-5-6-7-8-9-0

M.....  
P.....  
S.....  
1-2-3-4-5-6-7-8-9-A-B-C-D-E-H-K-L

PERRIER

BRICARD - PERRIER

ABUS - BRICARD

PER:  
FOR:

GRIFO

GSS

GTV

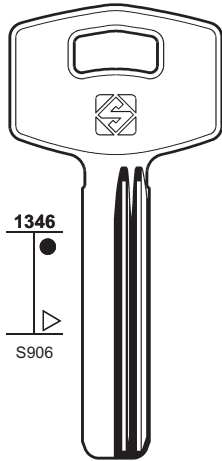

GF1

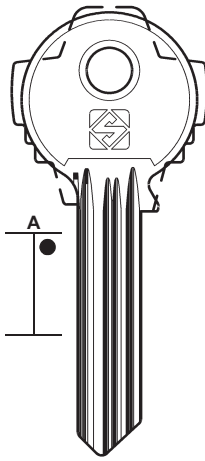

GSS1

GOAL

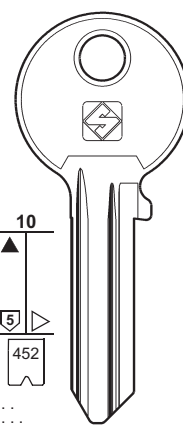

.....  
0-1-2-3-4-5-6-7-8-9



GV1



GV2



GV3



GV4R



GV5R



GV6R

TIEFENTHAL

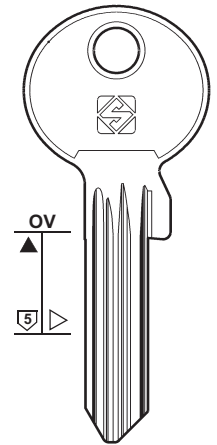

GV7

JOWIL - TIEFENTHAL

PER:  
FOR:

GUARD

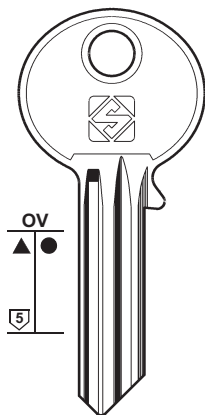

GD8



GD8R

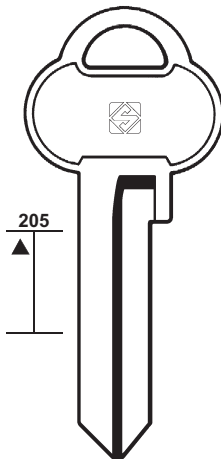

GD5

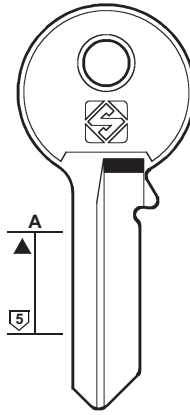

GD2

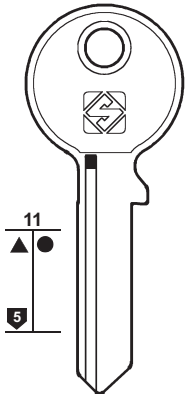

GD4



ABUS - EKLA - ROYAL

PER:  
FOR:

## GUARD

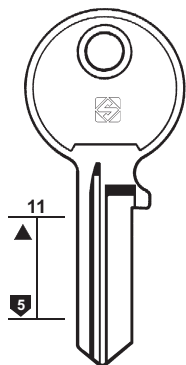

**GD6R**

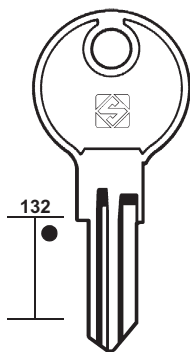

**GD3**

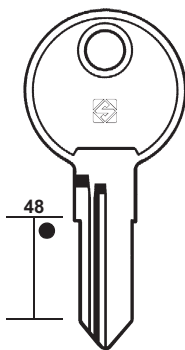

**GD7R**

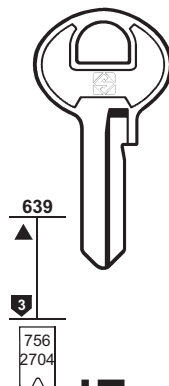

**AB23**

... 1-24  
... 65/251-2-3-4-5

**AB23R**



**GD1**

**GD1R**



# 91

PER / FOR

**GUARD (HK) (CZ)**  
ABUS

+ ABUS (8)  
+ FAB (74)

**GUARDIAN (I)**

+ CAS-CISMA (40)  
+ F.F. (78)

**GUARUP (BR)**

**GUSHENG (CHN)**

**GUIDOTTI (F)**

+ RONIS (146)

**GUITTEL (F)**

+ ABUS (8)

**GÜTLER (D)**

+ SIMECA (155)

**HÄFELE (D)**

+ BKS (30)  
+ CES (41-42)  
+ DOM (61-62)  
+ HUWIL (94)  
+ KIFERM (106)  
+ LAS (110)

**HAGA (BR)**

**HAIDE (RC)**

+ YETI (198-199)

**HALLE (D)**

+ BAB (26)

**HAMPTON (GB)**

+ MASTER (119)

**HANNO (D)**

+ CES (41-42)

**HARLOC (USA)**

+ EAGLE (67)

PER:  
FOR:

## GUARUP

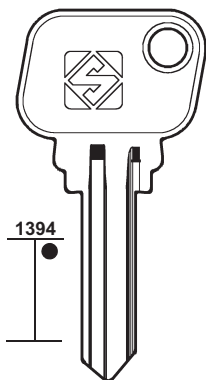

**GUR1**

## GUSHENG

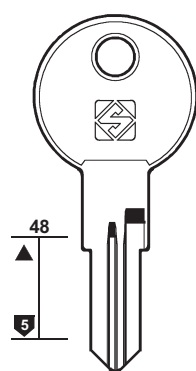

**GUS1**

## HÄFELE

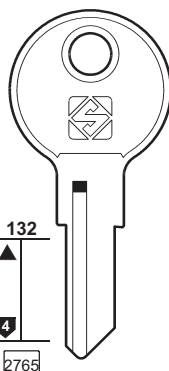

**HF1R**

TA ... 100-999

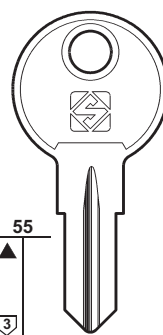

**HF73R**

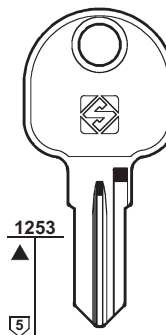

**HF74 HF74R**

... 1-200

PER:  
FOR:

## HÄFELE

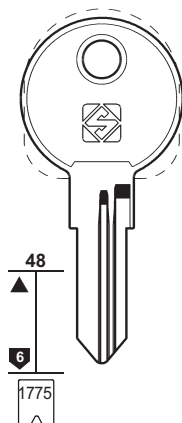

**HF75**

+ **HF75R**  
... 1-3936

## HAGA

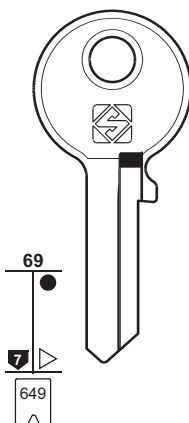

**HAG1**

+ **HAG1R**

..... 1-2-3-4-5-6

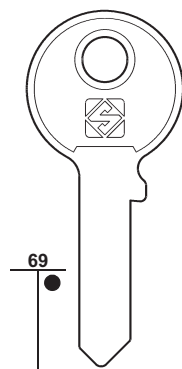

**HAG6R**

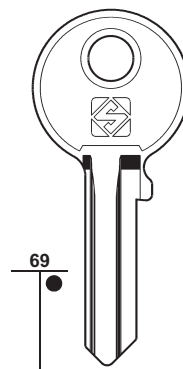

**HAG7**

+ **HAG7R**

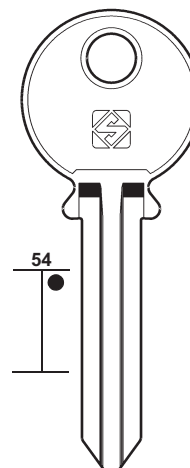

**HAG5**



92

PER / FOR

HARP (HK)

HASLER (D)  
+ SEA (152)

HASMAN (IND)

HB (I)  
 LEGALLAIS (111)

HBC (D)  
 MELSMETALL (122)

HDL-PACRI (BR)

HECTOR (E)

HEGO (D)  
 CORBIN (53)

HEKNA (D)  
METALCASTELLI  
RAUCO  
REGENT  
+ DOM (61)  
+ HR (93)

HEL (E)

HEMA (RC)  
 VACHETTE (181)

HEMY (F)  
 YETI (198-199)

PER: FOR:	HARP	HASLER	HASMAN	HDL-PACRI
	 41 4	 582	 87	 A
	 HP1R	 HS1R	 HA1R	 HDL3 HDL3R

PER: FOR:	HDL-PACRI	HECTOR	HEKNA
	 1430 4	 1308	 30 5 142 237 P98 5 237
	 HDL1R	 HCT1R	 HN1 HN2 ..... 1001-1425 C..... 1251-1700 HN4 HN5R HN1P ..... 1001-1425
			 METALCASTELLI - RAUCO REGENT

PER: FOR:	HEKNA	HEL
	 55 5 755	 A 7 54 6 A 5
	 HN6 HN3 HN3R ..... 1-2-3-4 ..... 1501-1540	 HN7 HE3R HE2 HE2R HE1 HE1R

PER: FOR:	HENDERSON	HILLO	HK	HOK	HOPPE
	167 4 272	11 5	49 4	1434 5	1261 5 1643
	 <b>HEN1</b> R... 008-254	 <b>HL1R</b>  mm 40	 <b>H1 H1R</b>  mm 20	 <b>HOK1R</b> 	 <b>HPP1 HPP1R</b> ... 1001-3187 
	<b>REGENT</b>	<b>GLOBE - HERO</b>			<b>BURG - KIND - MAUSER</b>

PER: FOR:	HORSE	HR	HTV
	438 5	521 5	132 5 1809
	 <b>HO1R HO2R</b>	 <b>HR1</b> E 	 <b>HT1 HT1R</b> 07 
		<b>HEKNA - HERO - OJMAR</b>	<b>VAUGHN SHAW - VAUGHN - YALE</b>

PER: FOR:	HUDSON	HUGIN	HUGO
	132 5 142	178 5	616 5 1219
	 <b>HD1R HD1 HD2 HD2R</b> A... 201-1050 C... 500-699 H... 601-1100 HM... 201-1050 	 <b>HG1 HG2</b> A 	 <b>HG3 HGO1R</b> P 

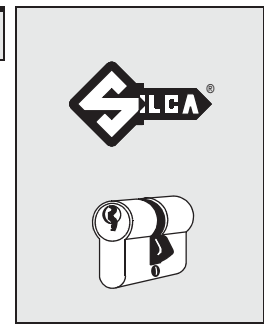

# 93

- PER / FOR**
- HENDERSON (GB)**  
REGENT  
+ UNION (176)
  - HERMES (RC)**  
 YETI (198-199)
  - HERO (D)**  
 HILLO (93)  
 HR (93)
  - HESTE (D)**  
 CORBIN (53)
  - HILLO (RC)**  
GLOBE  
HERO
  - HK (D)**
  - HMP (RC)**  
 ALPHA (15)
  - HOBBY (GB)**  
 EURO LOCKS (71)
  - HÖHRMANN (D)**  
 BKS (30)  
 CES (42)  
 DOM (62)  
 GEGE (84)
  - HOK (TR)**
  - HOPPE (D)**  
BURG  
KIND  
MAUSER  
+ BURG (38)
  - HOOPLY (PRC)**  
 WANJIN (188)
  - HORSE (RC)**
  - HR (D)**  
HEKNA  
HERO  
OJMAR
  - H.R.S. (F)**  
 TH (166)
  - HSA (D)**  
 KJV (105)
  - HTV (GB)**  
SHAW  
VAUGHN  
YALE
  - HUDSON (USA)**  
+ FORT (81)  
+ SEGAL (153)  
+ YALE (194)
  - HUGIN (S)**
  - HUGO (D)**



94

PER / FOR

HUNIT (I)

+ FTH (82)

HUTRA (D)

+ SCHLECHTENDAHL (152)

HUWIL (D)

CEKA  
CHRIST  
HÄFELE  
L.M.C.  
MAUSER  
SCHÄRF  
STEELCASE  
STRAFOR  
WILLACH  
WÜRTH  
+ BOMORO (33)  
+ DOM (61)

IALEX (P)

IBFM (I)

+ L & F (116)

ICA (E)

ICSA (I)

ORLANDO  
REMO  
ZANI  
+ LINCE (112)

IDEAL (RC)

+ DOM (61)

IDEAL SECURITY (USA)

+ WEISER (189)

IDRO STOP (I)

CEV

PER: HUNIT  
FOR:

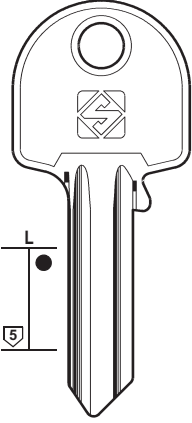

HUT1

HUWIL

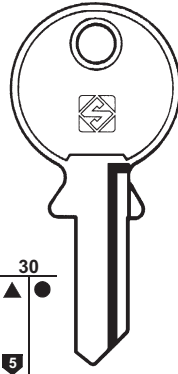

238  
501  
2500  
..... 2001-2207  
..... N 2001-2204  
N ..... 2001-2207  
N ..... 5-1878  
..... SO 8101-8300  
LM ..... 7946-8149



HW1

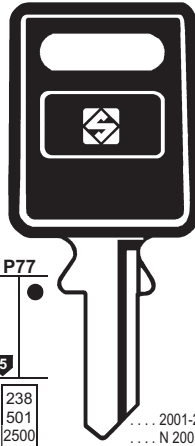

238  
501  
2500  
..... 2001-2207  
..... N 2001-2204  
N ..... 2001-2207  
N ..... 5-1878  
..... SO 8101-8300  
LM ..... 7946-8149



HW1P

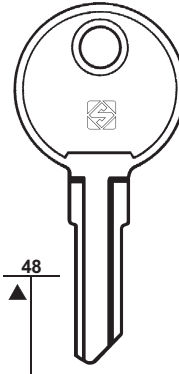

HW2  
R



HW3  
V

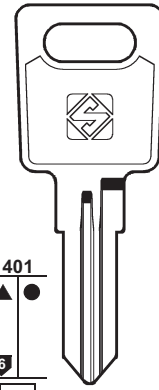

538  
1437



HW4

HW4R

... 000-051  
... 0001-1915  
... 0A-9Z  
IG ..... 14101-16020  
... 22001-23920  
DE ..... 25500-27419  
..... A 3001-4000  
W ..... 3001-4000  
..... 3001-4001  
..... 3010-3999  
..... 3202-4004  
..... A 5001-5050  
A ..... 5001-5050  
..... 5001-6169  
..... 7000-8001  
PL ..... 7420-8419  
RA ..... 7480-8479  
..... 7526-7726  
FH ..... 7526-7726  
..... 8001-8321  
..... 8001-9541  
..... LH 8701-9700  
UO ..... 9000-9999

CHRIST - HÄFELE - L.M.C.  
WILLACH - WÜRTH

HÄFELE  
STRAFOR - STEELCASE

PER: HUWIL  
FOR:

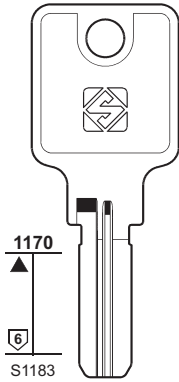

HW15R

CEKA - HÄFELE  
MAUSER - SCHÄRF

IALEX

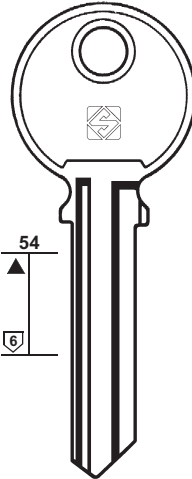

IX1 IX1R

IBFM

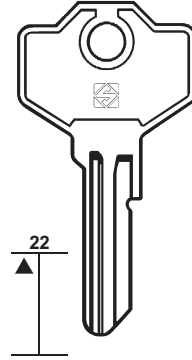

IBF1 IBF1R

ICA

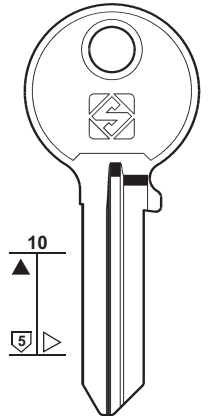

ICA1R

PER: ICSA  
FOR:

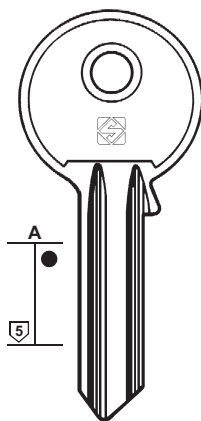

ICS1 ICS1R

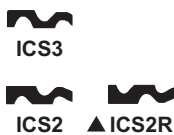
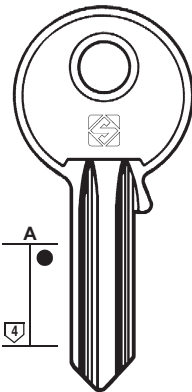

ICS2 ▲ ICS2R

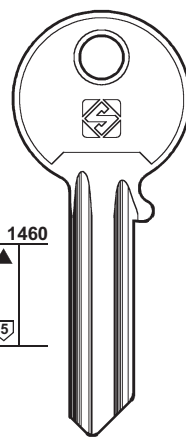

ICS5

ORLANDO  
REMO - ZANI

IDRO-STOP

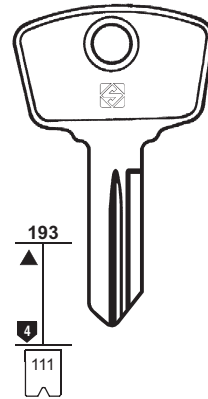

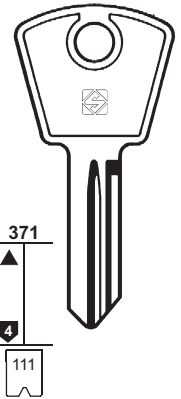

ISP2  
.. 1-78



ISP4  
.. 1-78



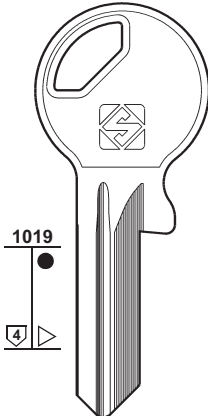
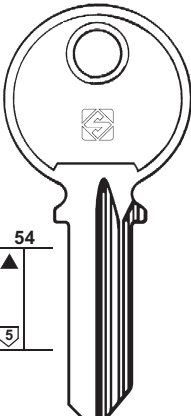
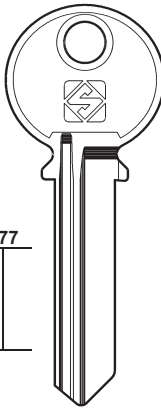
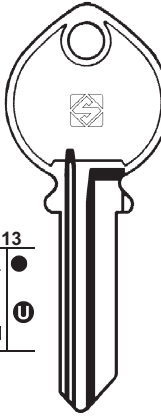
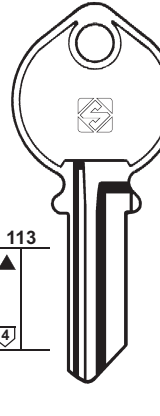

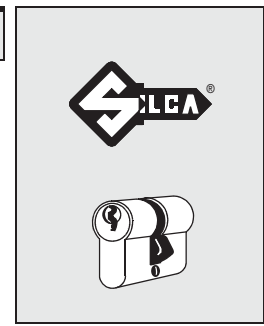

CEV







<b>PER:</b> <b>FOR:</b>	<b>IES</b>	<b>IFAM</b>			
 <p>1019 4</p>	 <p>54 5</p>	 <p>477</p>	 <p>113 5</p>	 <p>113 4</p>	
<b>IES1R</b>	<b>IF1</b>	<b>IF7</b> <b>IF7R</b>	<b>IF3</b> <b>IF3R ▲</b>	<b>IF2</b> <b>IF2R</b>	
			 mm 45-50-55	 mm 35-40 <b>RIPA</b>	









# 95

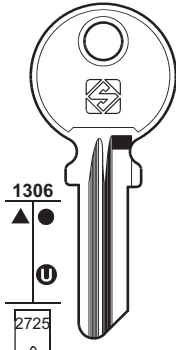
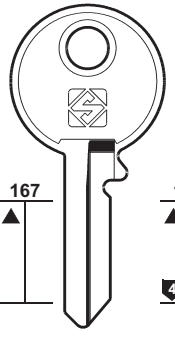
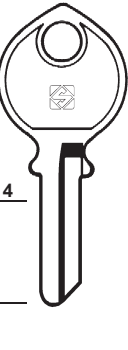
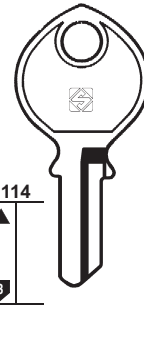
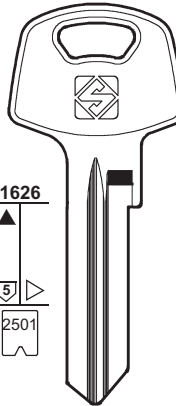
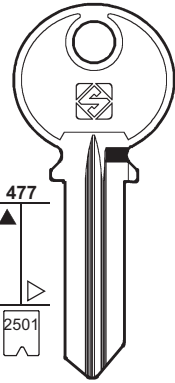

- PER / FOR**
- IES (I)**
- IFAM (E)**  
 BATU  
 JOMA  
 RIPA  
 TEM  
 +  BUGA (36)  
 +  CHICAGO (46)  
 +  CISA (50-51)  
 +  FTH (82-83)  
 +  GLOBE (88)  
 +  ISEO (97)

- IGS (F)**
- IJ (F)**  
 JTF  
 +  JTF (100)  
 +  MERONI (124)  
 +  STAR (161)

- IJN (F)**  
 KIFERM (106)

**ILARGI (E)**

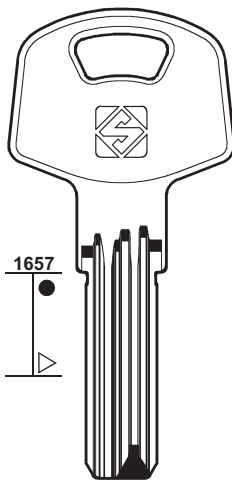
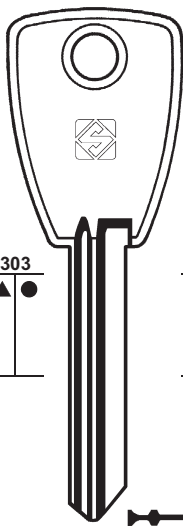
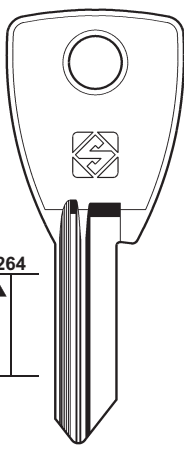
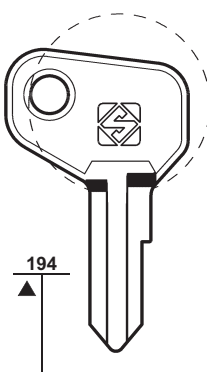
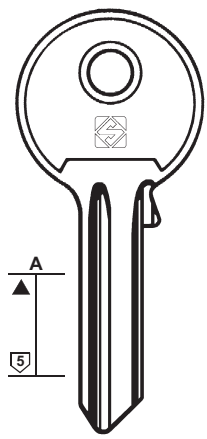
<b>PER:</b> <b>FOR:</b>	<b>IFAM</b>					
 <p>1306 2725</p>	 <p>167</p>	 <p>114 4</p>	 <p>114 3</p>	 <p>1626 2501</p>	 <p>477 2501</p>	
<b>IF6</b> ..... 4001-4240	<b>IF8</b>	<b>IF4</b>	<b>IF5</b>	..... (D) 0123456 (D) ..... 55002-58124	..... (D) 0123456 (D) ..... 55002-58124	
	<b>IF8R</b>	<b>IF4R</b>	<b>IF5R</b>	<b>IF12R</b>	<b>IF13R</b>	
 <b>JOMA</b>	  <b>JOMA</b>	 <b>BATU - RIPA - TEM</b> mm 25	 <b>JOMA - TEM</b> mm 20			

<b>PER:</b> <b>FOR:</b>	<b>IFAM</b>	<b>IGS</b>		<b>IJ</b>	<b>ILARGI</b>
 <p>1657</p>	 <p>303</p>	 <p>264</p>	 <p>194</p>	 <p>A 5</p>	
<b>IF14</b>	<b>IS2</b>	<b>IS1</b>	<b>IJ1</b>	<b>IL1R</b> <b>IL1</b>	
			 <b>JTF</b>		



96

PER / FOR

ILCO (USA)  
BARGMAN

ILLINOIS (USA)

DUO  
GRAYHILL  
LAGRANGE  
OTIS  
SEEBURG  
+ CHICAGO (45)

ILS (I)

+ FASEM (77)

IMAB (BR)

IMBAC (F)

PREFER (143)

IMP (D)

ABUS (8)

IMSI (I)

PERINO (140)

INDAUX (E)

FAC (75)

INDESIT (I)

ELSI  
MIT  
RECA

INGERSOLL (GB)

PER:  
FOR:

ILCO

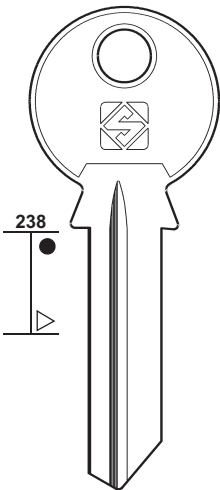

ILC13R

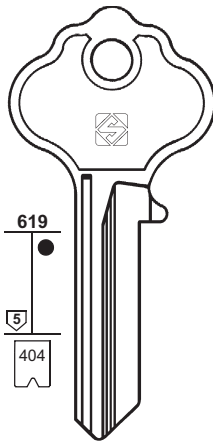

ILC2

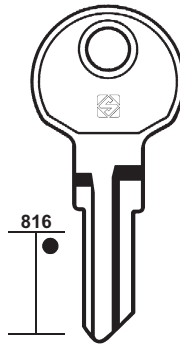

ILC6

BARGMAN

ILLINOIS

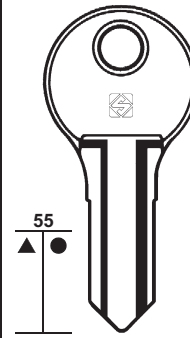

IN1



NUOVO PIGNONE  
GRAYHILL - LAGRANGE  
OTIS - SEEBURG

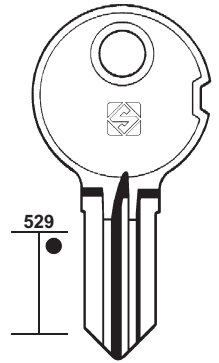

IN2  
H IN3  
J



PER:  
FOR: ILLINOIS

ILS

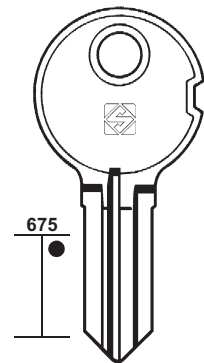

IN5



DUO

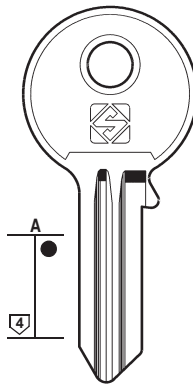

ILS1



IMAB

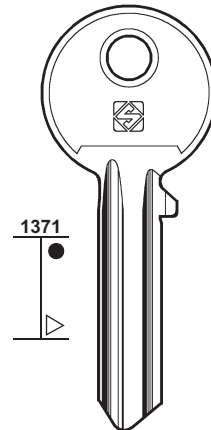

IAB7

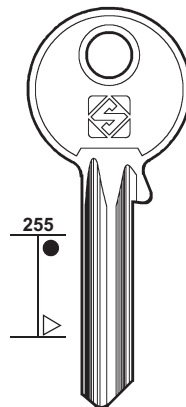

IAB8

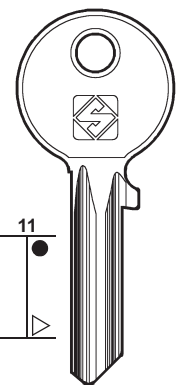

IAB9



PER:  
FOR:

INDESIT

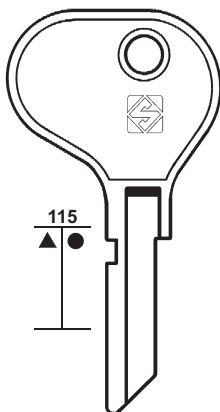

ID1  
REG

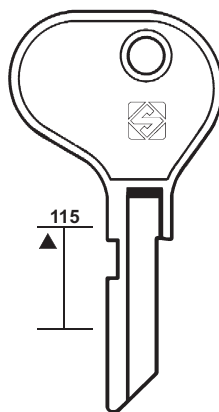

ID2  
X

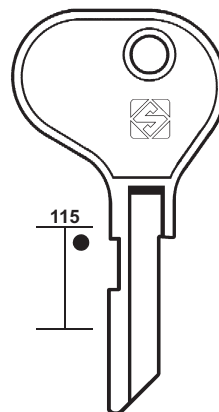

ID3  
MGR



INGERSOLL

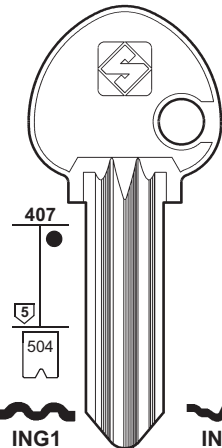

ING1  
A . . . . . 1-2-3-4

ING2  
W







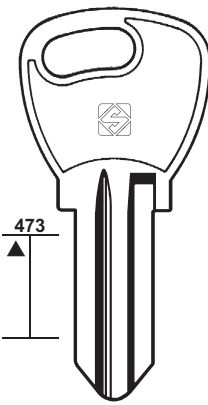
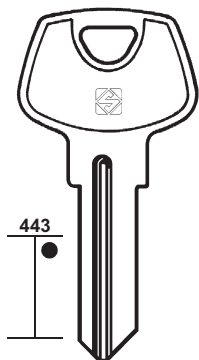

ING5  
S . . . . . 1-2-3-4

ING6  
N

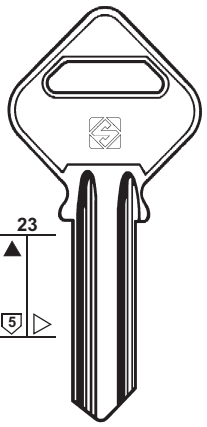

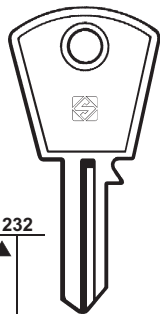
ELSI - MIT - RECA





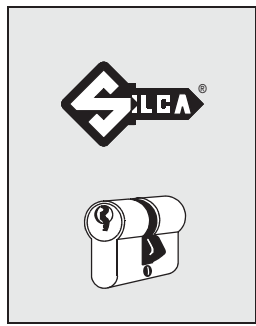





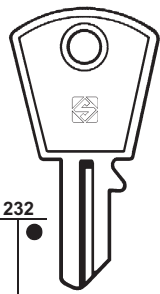



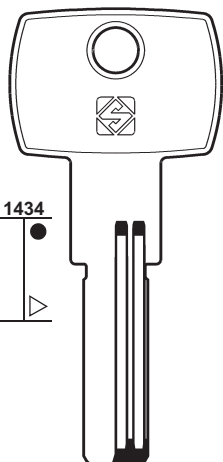

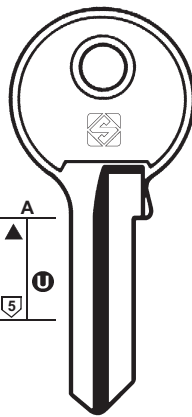

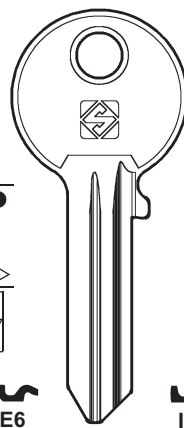

PER: FOR:	INGERSOLL	INSA	INT
	 473  443  ING3  ING4R	 23  INS1	 232  IT1  IT1R 











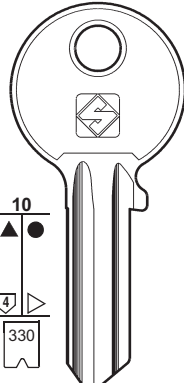

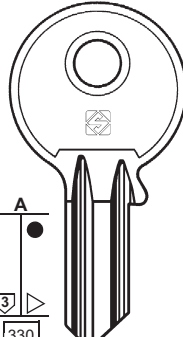

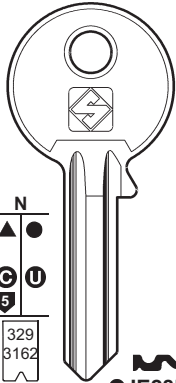



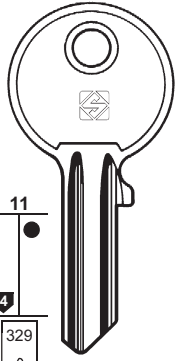







# 97

PER / FOR  
**INGERSOLL (GB)**  
**INLOC (F)**  
 BRICARD (35)  
**INSA (I)**  
**INT (I)**

PER: FOR:	INT	I.R.	ISABEL FAINER'S	ISEO
	 232  IT2  IT2R 	 1434  IR1 	 A  IB1 	 10  330 2567  IE6 IFAM - STAR ..... 012345678 LCE ..... 1-17513 Y ..... 1-2000 YO ..... 1-2000  IE6R ..... 012345678 KFC ..... 1-28800 ..... 1-6516  IE10  IE2R ..... 1-2000 0-1-2-3-4-5-6-7-8  IE9 ..... 1-2000 ME ..... 1-210 CAM  IE13 ..... 0-1-2-3-4-5-6-7-8-9  IE12  IE31  IE27R F3 ..... 0-1-2-3-4-5-6-7-8-9

I.R. (F)  
 + DOM (63)  
 + W.M.S. (192)  
**ISABEL  
FAINER'S (P)**  
**ISEO (I)**  
 CAM  
 IFAM  
 STAR  
 + VACHETTE (180)

PER: FOR:	ISEO				
	 10  330 ..... 0-1-2-3-4-5-6-7-8	 A  330 ... 0-1-2-3-4-5-6-7-8	 N    329 3162 ..... 1-2-3-4-5-6  IE28R F3	 11  329 .... 1-2-3-4-5	 74  329 ... 1-2-3-4-5
	 IE7  IE7R  IE224  IE225	 IE8  IE8R	 IE3  IE3R ..... 1-2-3-4-5-6  IE1  IE1R ..... 1-2-3-4-5-6	 IE4  IE4R	 IE5



98

PER / FOR

ISEO (I)  
ATRA  
CITY  
VACHETTE  
+ VACHETTE (180)

ISSERSTEDT (D)  
CORBIN (53)

ITALBLOCK (I)  
EUREKA (70)

ITO (TR)  
CISA (48)  
FTH (83)

ITOKI (J)

IULIA MAS FED (I)  
FASEM (77)

PER:  
FOR:

ISEO

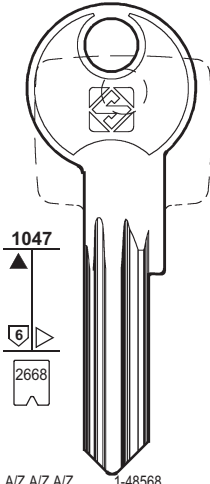

1047  
6  
2668

A/Z A/Z A/Z ..... 1-48568

F6  
IE29

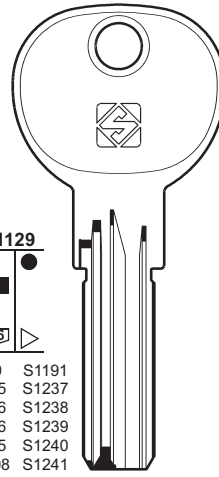

1129  
5+6+6

S99 S1191  
S725 S1237  
S726 S1238  
S916 S1239  
S965 S1240  
S1108 S1241

EDL .....  
CFA ..... 1-27065  
EDL ..... 1-350589  
ECA ..... 1-050000  
ECA ..... 100001-150000  
EDA ..... 1-350589  
EDY ..... 1-350612  
EGE ..... 1-027508  
EGE ..... 100001-127508  
EGE ..... 200001-227508

HNH  
IE14  
R11

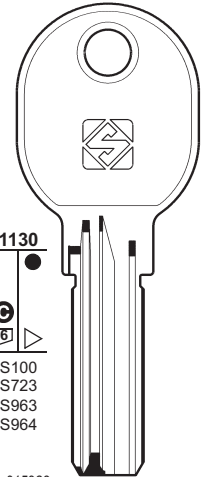

1130  
5+6+6

S100  
S723  
S963  
S964

ABL ..... 1-015328  
ACY ..... 1-015328  
AGL ..... 1-015328  
ABF ..... 1-015694

HNH  
IE15  
R6



CITY - VACHETTE

PER:  
FOR:

ISEO

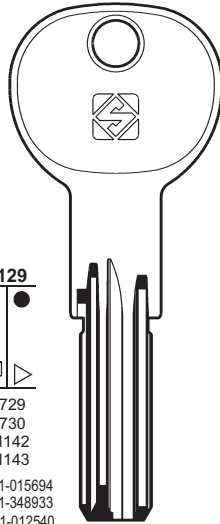

1129  
5+6+6  
S729  
S730  
S1142  
S1143

AAC ..... 1-015694  
DAA ..... 1-348933  
AMB ..... 1-012540  
AMB ..... 100001-112540

HNH  
IE26



ATRA - CITY

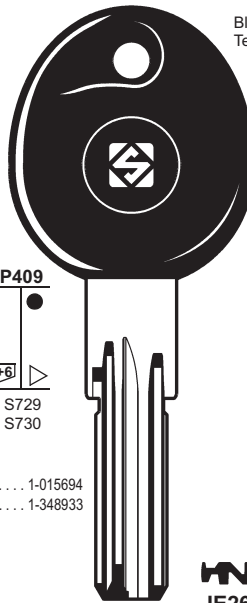

P409  
5+6+6  
S729  
S730

AAC ..... 1-015694  
DAA ..... 1-348933

HNH  
IE26P

Blue head  
Testa blu

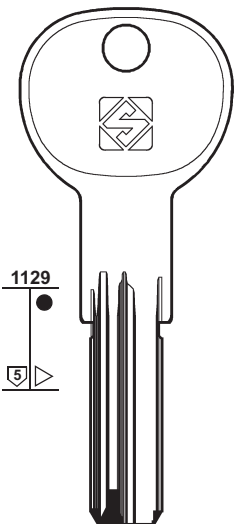

1129  
5

HNH  
IE30



PER:  
FOR:

ITO

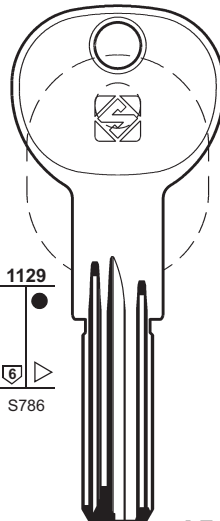

1129  
6  
S786

HNH  
IO1



ITOKI

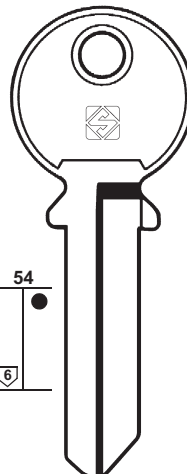





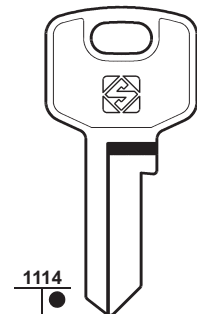

54  
6

ITO1R ITO2 ▲

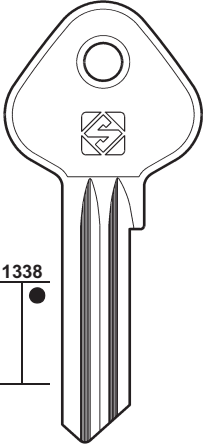
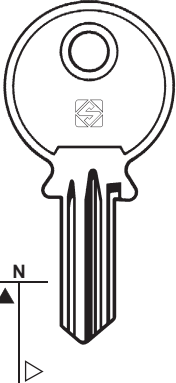
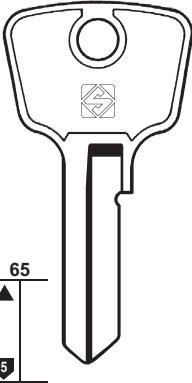
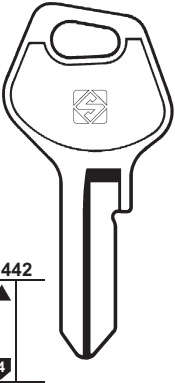

1114





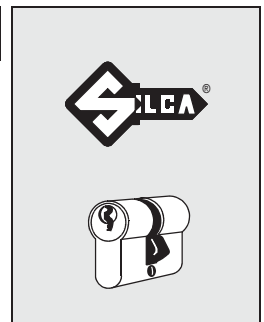



ITO3 ITO3R

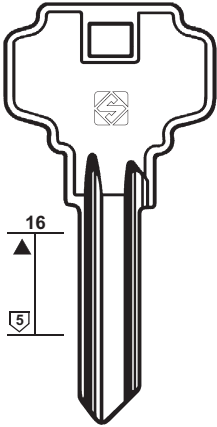
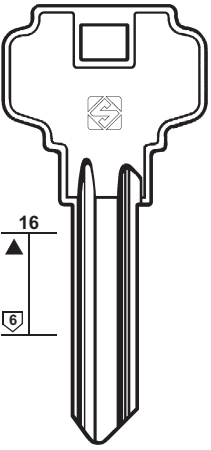
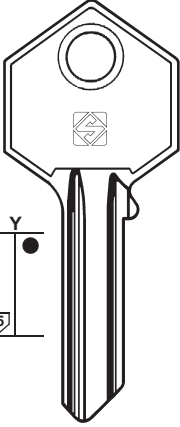







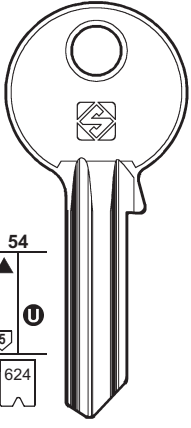
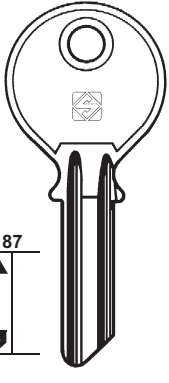
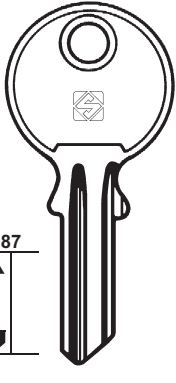
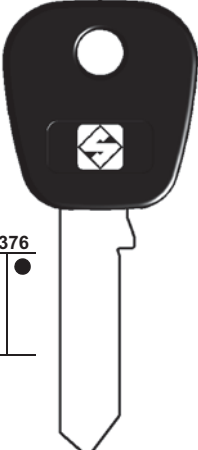

PER: FOR:	IWATA	JÄBA	JAPAN	
	 1338	 N	 65	 442
	 IW1R	 JB1	 JPN1	 JPN3R
			 ● JPN2	 JPN3R



**99**

PER / FOR
IWATA (J)
JÄBA (DK)
JAPAN (J)
JARDI (E)
JD (J) 👁️ ALPHA (15)
JEHU (RC)
JET (D) 👁️ ABUS (7)
JIP (F) 👁️ PREFER (142) 👁️ RONIS (146-147)
JIS (E) SEMEL
JL (F) 👁️ FTH (81)
JMR (E) 👁️ EZCURRA (73)
JNF (IL) 👁️ EVERGOOD (71)
JOLY (F) 👁️ GABON (84)
JOMA (E) 👁️ IFAM (95)
JORE (D) 👁️ WILKA (191)
JOSTA (D) 👁️ CES (41-42)

PER: FOR:	JARDI	JEHU	JIS
	 16	 16	 Y
	 JAR1	 JH1	 JS1
	 JAR1R	 JAR2	 JS1R
	 JAR2R	 mm 60	

PER: FOR:	JIS			
	 54	 87	 87	 P376
	 JS2	 JS2R	 JS4	 JS4R
	 0-1-2-3-4-5-6-7-8-9	 ● JS3	 JS3R	 JS5P
				



# 100

### PER / FOR

#### JOWIL (D)

ESZ  
FUHR  
GTV  
JÜNGST  
MERCUR  
OSKO  
PANTHER  
TIEFENTHAL  
TRITON  
VOKO  
WEPA

+ EMR (69)

#### JPM (F)

+ ABUS (6-7)  
+ CISA (49)  
+ KESO (104-105)  
+ SIMECA (155)

#### JTF (F)

IJ  
+ IJ (95)  
+ MERONI (124)

#### JU (D)

+ KIFERM (106)  
+ VACHETTE (181)

PER:  
FOR:

## JOWIL

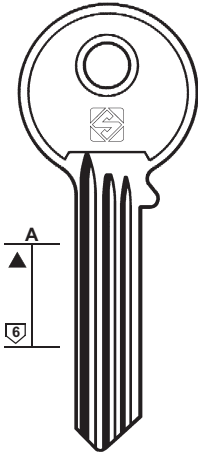

JOW8

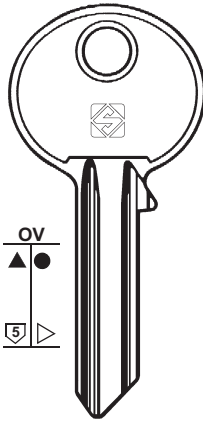

JOW1 JOW1R ▲

ESZ - FUHR - GTV  
JÜNGST - MERCUR  
OSKO - PANTHER  
TIEFENTHAL  
TRITON - VOKO - WEPA

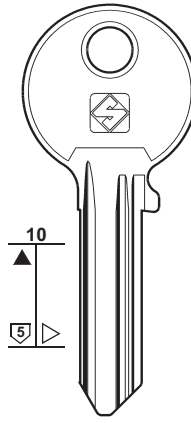

JOW2  
 JOW5  
 JOW6  
 JOW7  
 JOW9  
 JOW10

JOW11

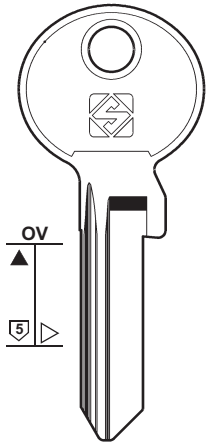

JOW12X JOW12RX

PER:  
FOR:

## JOWIL

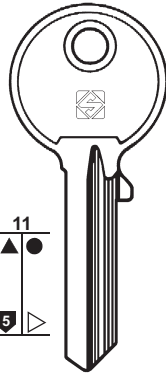

JOW3R

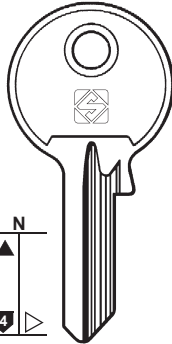

JOW4R

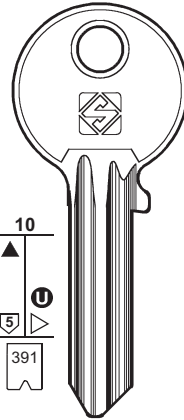

▲ JM3 JM3R ▲  
A .....  
X .....  
1-2-3-4-5-6-7  
▲ JM2 JM2R ⊕

JM1 ▲▲  
F3

AY .....  
BA .....  
BB .....  
BC .....  
BD .....  
BD .....  
BL .....  
BM .....  
BN .....  
BP .....  
BQ .....  
BR .....  
BS .....  
BT .....  
BU .....  
BY .....  
F3C .....  
SA .....  
SB .....  
1-6032

JM1R ▲  
F3  
F3D .....  
1-6032

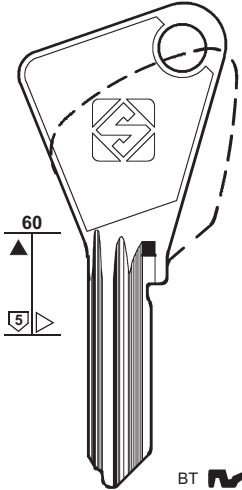

BT JM6

BK JM7

PER:  
FOR:

## JTF

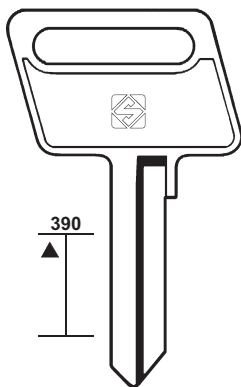

JT1  
JA

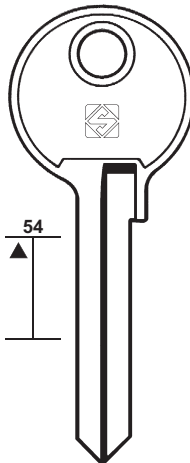

JT2R

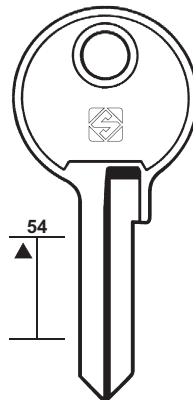

JT3R



## JU

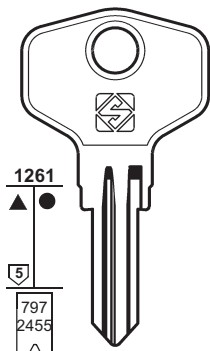

JU11 JU11R  
D A  
..... (A) 1-2-3 ..... (D) 1-2-3  
B ... (D) 376-500+(507-508) B ... (A) 001-125+(501-502)

JU12 JU13R  
C B  
..... (B) 1-2-3 ..... (B) 126-250+(503-504)  
B ... (C) 251-375+(505-506)



PER: **JUNGHEINRICH**  
FOR:

**JUNIE**

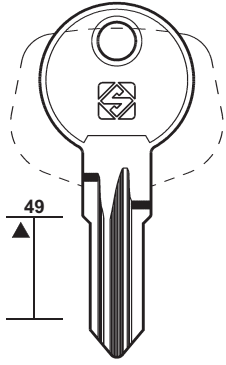

JR1R

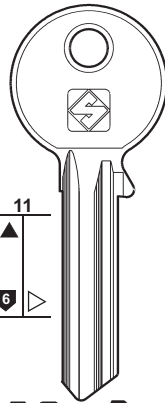

JU3 JU4

JU6 JU8

JU14

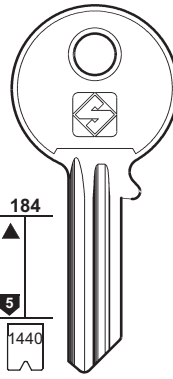

JU2 JU2R

JU7 JU10

0-1-2-3-4-5-6-7



PEROHAUS - VS

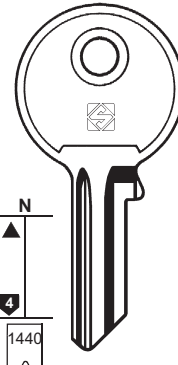

JU1 JU1R

... 0-1-2-3-4-5-6-7  
NN ... 2001-2998



PEROHAUS - VS



**101**

PER / FOR  
**JUNGHEINRICH (D)**

**JUNGHWA (J)**

**JÜNGST (D)**  
JOWIL (100)

**JUNIE (D)**  
PEROHAUS VS

**JUNKUNC (USA)**  
ALSO  
AMERICAN  
FEDERAL  
LION

**JUWEL (I)**  
+ FASEM (77)

PER: **JUNIE**  
FOR:

**JUNGHWA**

**JUNKUNC**

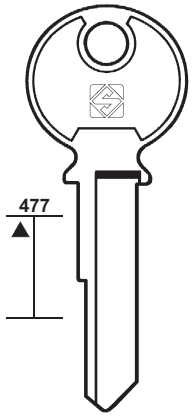

JU5

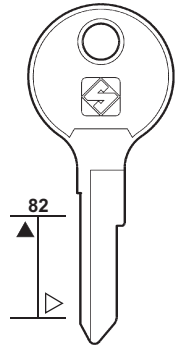

JU9

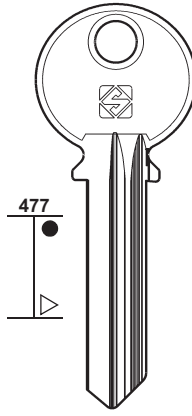

JN1R

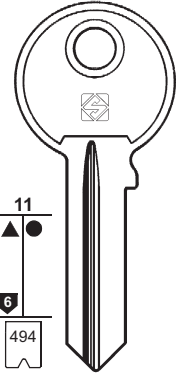

JC2R

... 80000-88999

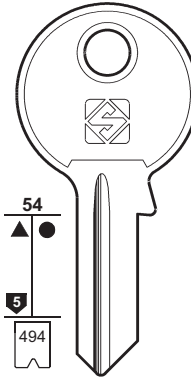

JC1

... 1-2-3-4-5-6-7-8



ALSO - AMERICAN - FEDERAL - LION



PER: **JUWEL**  
FOR:

**JUWEL**

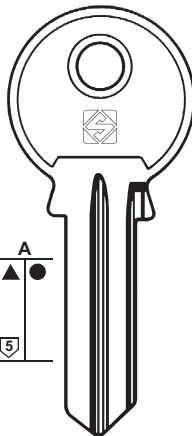

JW4R 2

JW5 3

JW6 5

JW7R 10

JW8 51

JW9 52

JW12

JW13 16

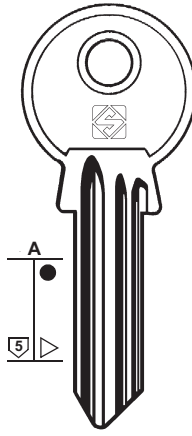

JW1R

JW1

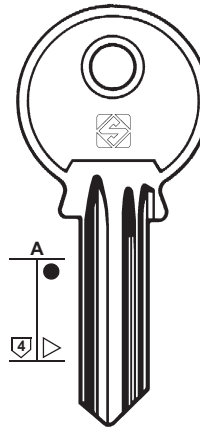

JW2R

JW2



# 102

### PER / FOR

**JUWEL (I)**  
+ FASEM (77)

**JVAL (P)**  
FEB  
P.C.  
SAVIO  
+ P.C.  
(CORTELLEZI) (140)

**KABA (CH)**  
BORKEY  
LÄSBOLAGET  
PICARD

PER:  
FOR:

## JUWEL

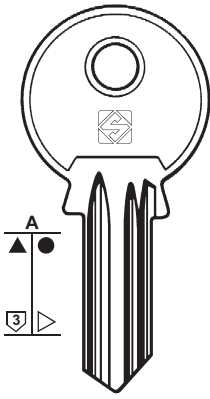

JW3

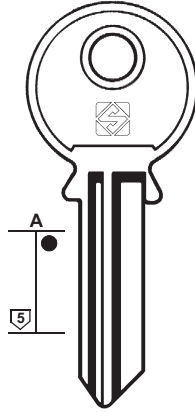

JW11

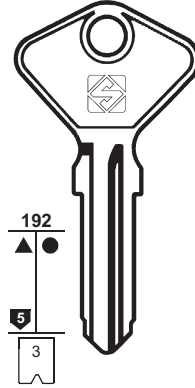

AF4C  
6...  
100-309



AF4D  
8...  
100-309

## JVAL

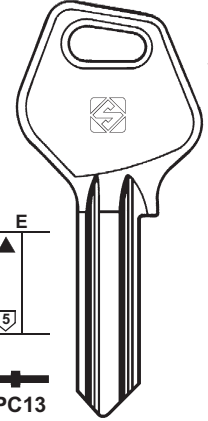

PC13



VL5E



VL5RE



JL3



JL3R

FEB - P.C. - SAVIO

PER:  
FOR:

## JVAL

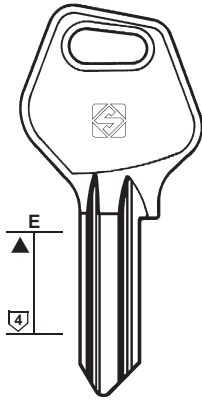

JL5

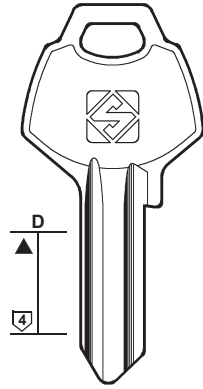

JL2



JL2R

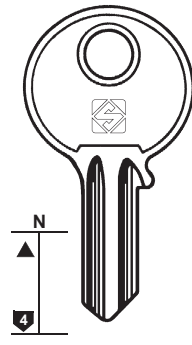

JL1



VL2RE



JL4



JL4R

FEB - P.C.

FEB

## KABA

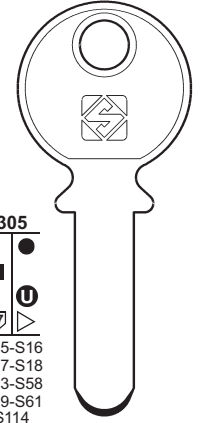

S15-S16  
S17-S18  
S53-S58  
S59-S61  
S114

PH...  
0001-9000  
... 1-200



KA1  
8



mm 2

LÄSBOLAGET

PER:  
FOR:

## KABA

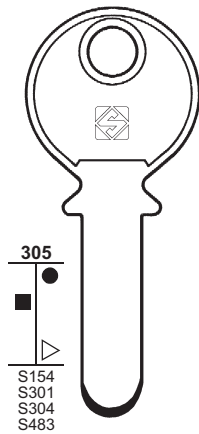

S154  
S301  
S304  
S483



KA2  
20



mm 2,5

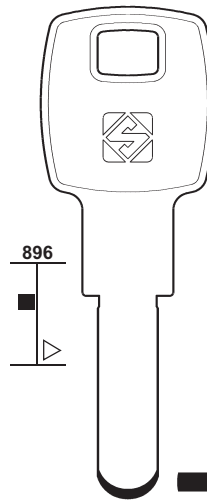

KA7



mm 2,5

PICARD

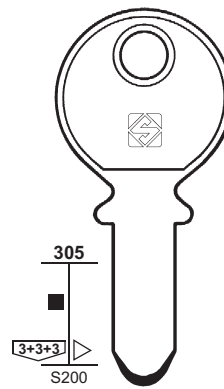

S200



KA6



mm 2,5

BÖRKEY

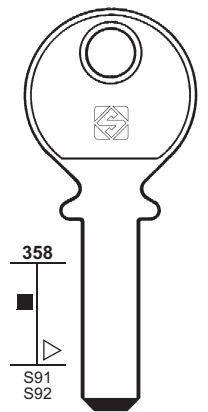

S91  
S92



KA3  
MINI KABA



mm 2,5

PER:  
FOR:

# KABA



# 103

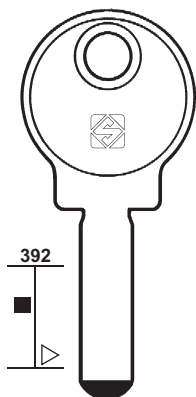

**KA4**

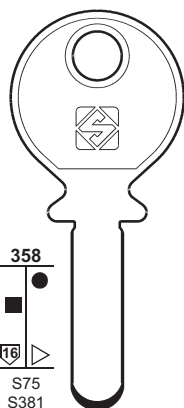

**KA5**

GEMINI



DORSET

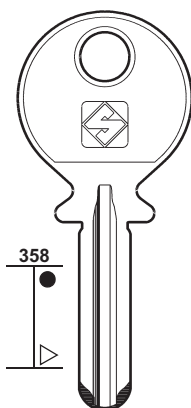

**KA9**

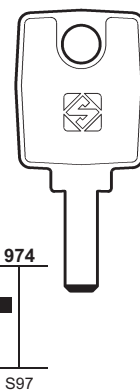

**KA8**

MICRO KABA



PER / FOR

**KABA** (CH)  
DORSET

**KAKEN** (ROK)

**KALE** (TR)

- + ABUS (7)
- + BUVA (39)
- + TESA (166)

PER:  
FOR:

# KAKEN

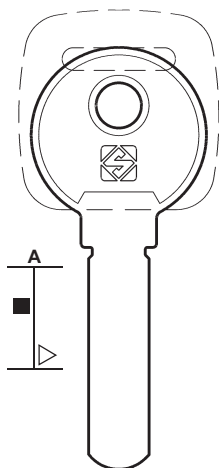

**KAK1**



# KALE

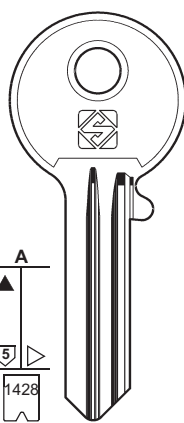

**KLE3R**

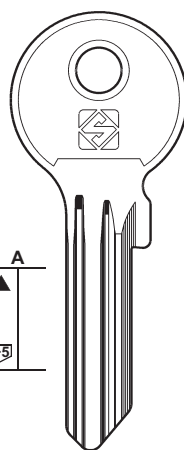

**KLE3X**

**KLE3RX**

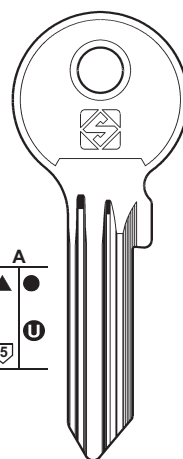

**KLE6X** ▲

**KLE6RX** ▲

..... 1-2-3-4-5-6-7-8-9

**KLE5X**

**KLE5RX**

**KLE7X**

**KLE7RX** ⊖

PER:  
FOR:

# KALE

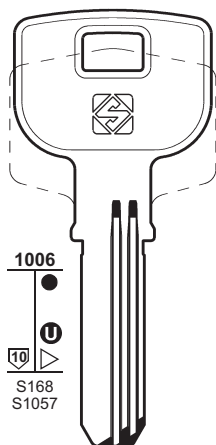

**KLE1**

**KLE4**

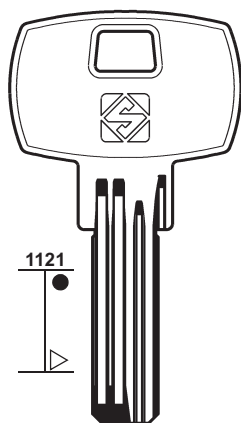

**KLE2R**

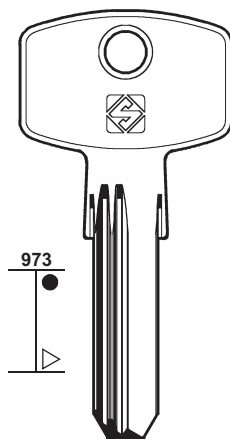

**KLE8R**

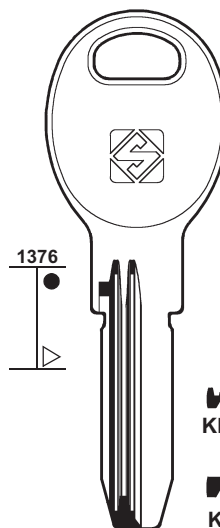

**KLE10R**

**KLE9R**





# 104

PER / FOR

**KALUGA** (RUS)

**KARDEX** (F)

👁️ CES (41-42)

👁️ RONIS (147)

👁️ VINCO (186)

**KARO** (E)

👁️ FTH (82)

**KASPIJSK** (RUS)

**KATE** (D)

👁️ SIMECA (155)

**KAWE** (D)

👁️ CORBIN (53)

👁️ TESA (165)

👁️ WEISER (189)

**KAZAN** (RUS)

**KEIL** (USA)

**KESO** (CH)

JPM

PER:  
FOR:

## KALUGA

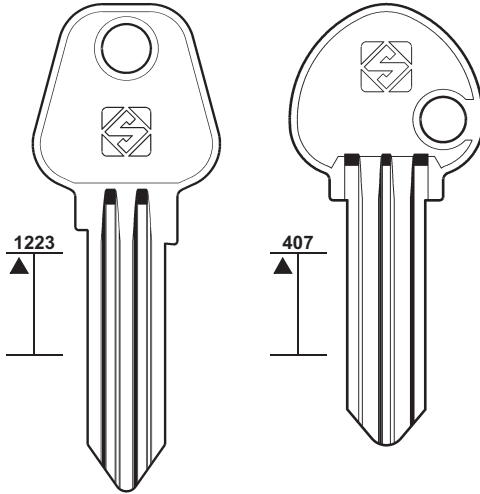

**KL G1 R**

**KL G2 R**

**RUS 2**

## KASPIJSK

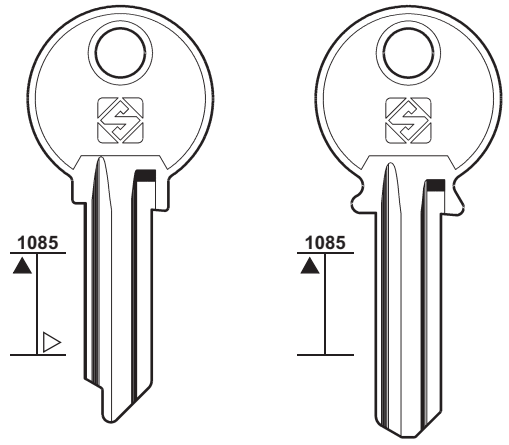

**KAP 1**

**KAP 1 R**

**RUS 1**

**RUS 1 R**

PER:  
FOR:

## KAZAN

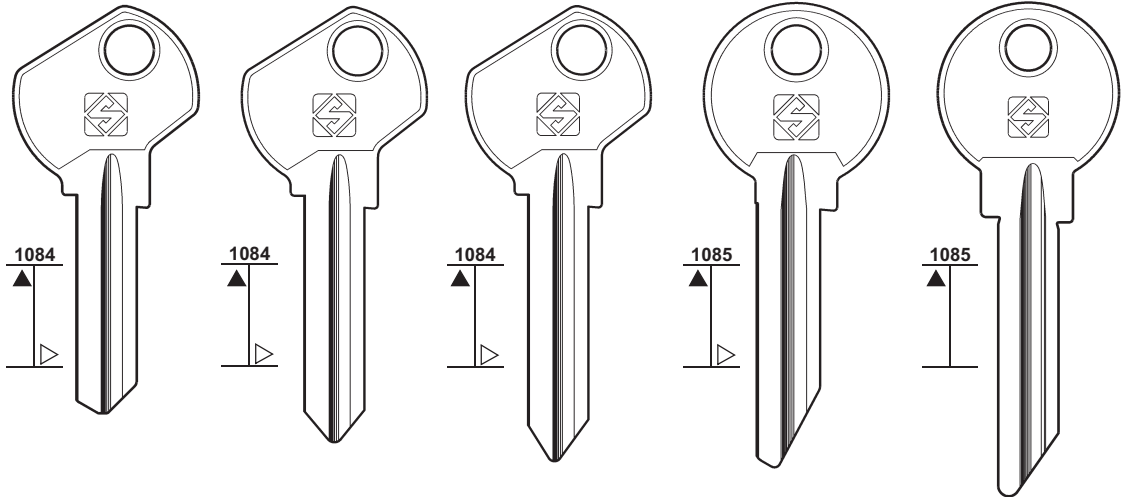

**KAZ 1 R**

**KAZ 4 R**

**KAZ 5 R**

**KAZ 2**

**KAZ 2 R**

**KAZ 8 R**

PER:  
FOR:

## KAZAN

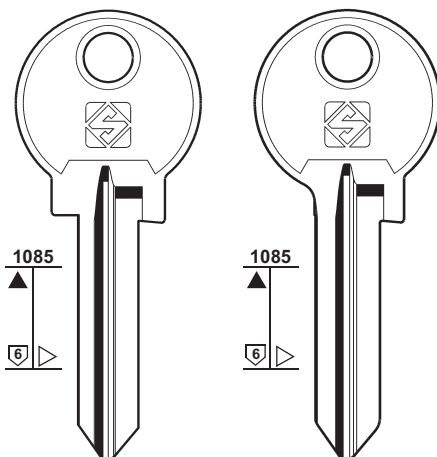

**KAZ 3 R**

**KAZ 7 R**

## KEIL

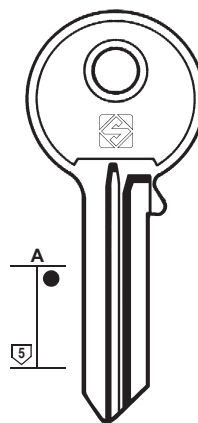

**KE 1 R**

## KESO

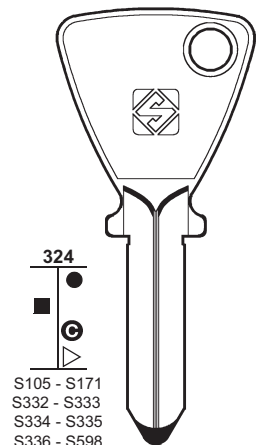

S105 - S171  
S332 - S333  
S334 - S335  
S336 - S598  
S599 - S600  
S601 - S678  
S259 - S807

**KE 1**



JPM



PER: **KESO**  
FOR:

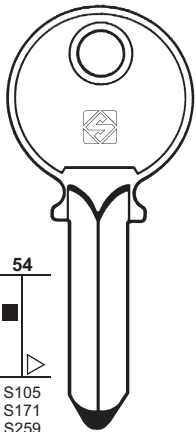

54

- S105
- S171
- S259
- S332
- S333
- S334
- S335
- S336
- S598
- S599
- S600
- S601

KE2



JPM

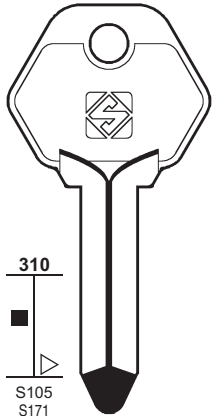

310

- S105
- S171
- S259
- S332
- S333
- S334
- S335
- S336
- S598
- S599
- S600
- S601

KE4



SARGENT

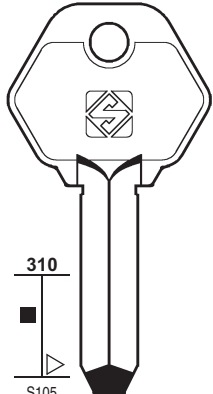

310

- S105

LP11



LIPS

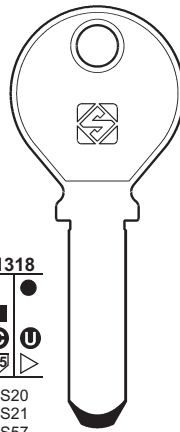

1318

- S20
- S21
- S57
- S267
- S273
- S277
- S359
- S1298

KE3



ALA

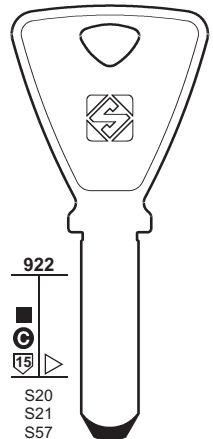

922

- S20
- S21
- S57
- S267
- S273
- S277
- S359
- S663
- S1298

KE9



JPM



105

PER: **KESO**      **KEYA**      **KFV**  
FOR:

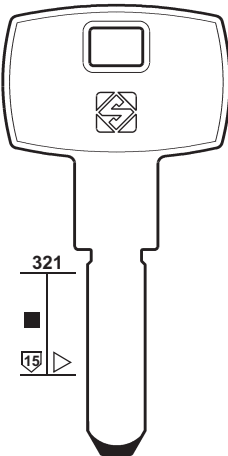

321

KE11



JPM

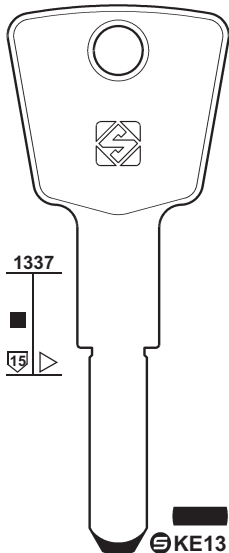

1337

KE13



FIAM

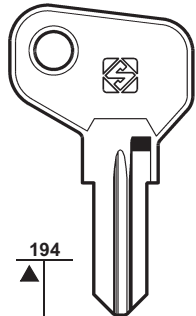

194

KEY1

KEY1R

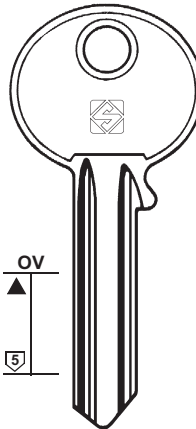

OV

KF1

- |  |  |
|--|--|
|  |  |
|  |  |
|  |  |
|  |  |
|  |  |
|  |  |
|  |  |
|  |  |
|  |  |
|  |  |

COMBA - FCV - FLIETHER  
GIESCHE - GÖTZ - GRAF - HSA  
NICO - SCHÜCO - SEN

PER: **KHARKOV**  
FOR:

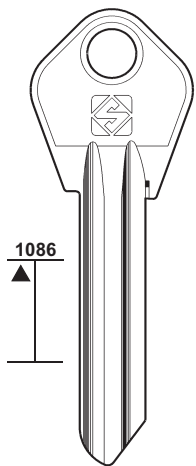

1086

HAK1

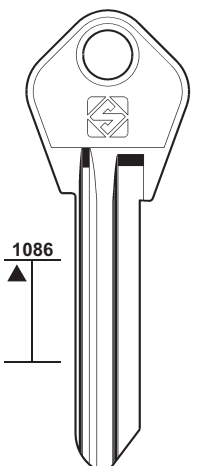

1086

HAK2

HAK6

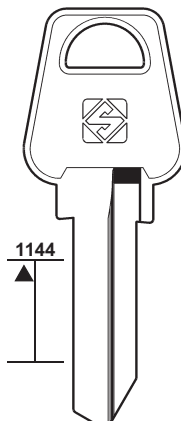

1144

HAK3

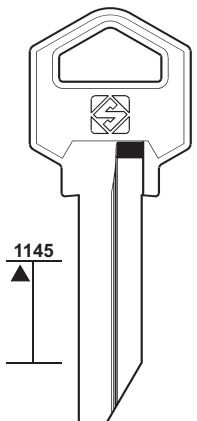

1145

HAK4

PER / FOR  
**KESO (CH)**  
ALA  
FIAM  
JPM  
LIPS  
SARGENT

**KEYA (E)**  
+ MELSMETALL (122)

**KFV (D)**  
COMBA  
FCV  
FLIETHER  
GIESCHE  
GÖTZ  
GRAF  
HSA  
NICO  
SCHÜCO  
SEN

**KHARKOV (UA)**



# 106

**PER / FOR****KIENZLE (D)**  
VDO**KIEV (UA)**  
METIZ**KIFERM (F)**

ATAL  
 CASH-BOX  
 DEF  
 GB  
 HÄFELE  
 IJN  
 JU  
 LAS  
 METEOR  
 ORDO  
 RENZ  
 SEIM  
 TEEN HAAF  
 WESCO  
 + LAS (110)  
 + RICOUARD (146)

**KILT (F)**

VACHETTE (180)

**KIMA (D)**

CES (42)

**KIND (D)**

CES (41-42)  
 HOPPE (93)

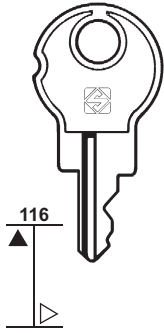
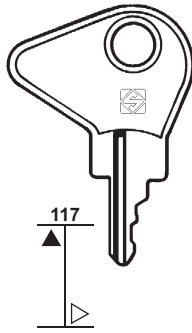
PER:  
FOR:**KIENZLE****KZ1****KZ2**

1

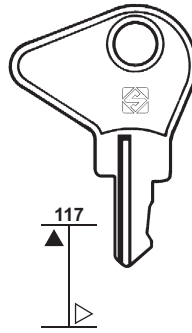
**KZ3**

2

VDO

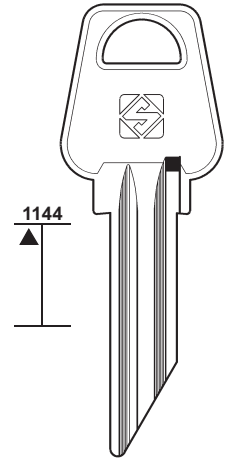
**KIEV****MTZ1**

METIZ

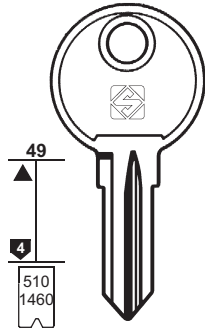
PER:  
FOR:**KIFERM****KI4**

... 1-50  
... 167  
X ... 167

**KI4R**

... 12359  
U ... 12359

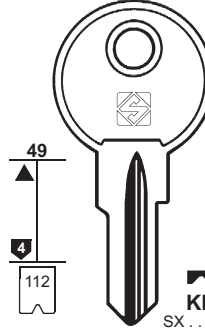
**KI5**

TX ... 1-275

**KI5R**

SX ... 1-275  
XT ... 1-75  
RX ... 1-275

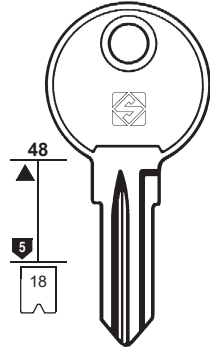
**KI6**

W ... 1-224

**KI6R**

Z ... 1-224

**KI12**

... 151-218  
... 101-150  
... 1116-7776  
H ... 1116-7776  
E ... 425-499

**KI12R**

... 1-68  
... 51-100  
H ... 500-574  
E ... 1116-7776

**KI7**

XY ... 1-275

**KI7R**

ATAL - IJN - JU  
 LAS - METEOR  
 RENZ - TEEN HAAF

**KI10**

Y ... 1-224

**KI10R**

C ... 1-224  
CA ... 1-224

DEF - GB  
LAS - ORDO

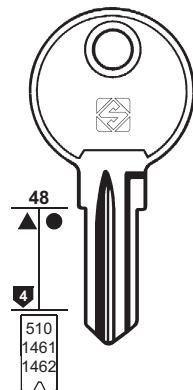
PER:  
FOR:**KIFERM****KI9**

... 226-293  
... 1-2-3

F ... 80-130  
... 258

**KI9R**

... 76-143  
CASH-BOX

DEF - HÄFELE  
LAS - WESCO

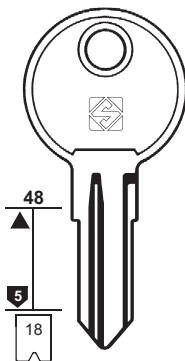
**KI13**

P ... 1-224

LAS

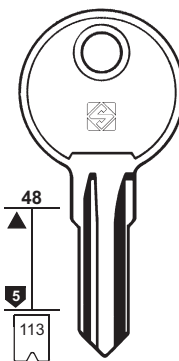
**KI16**

EX ... 1-224

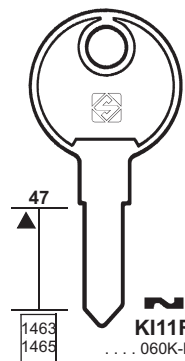

LAS

**KI11R**

... 060K-K660  
... 232L-L332

**KI14**

TL ... 1-50

**KI11**

... 232K-K332

**KI15**

S ... 1-20

**KI15R**

T ... 1-20

SEIM

PER: FOR:	KING	KIROVSMACH	KISHINEV	

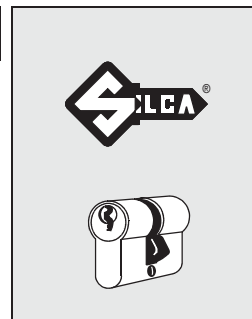

# 107

PER / FOR
<b>KING</b> (RC)
<b>KIROVSMACH</b> (RUS)
<b>KISHINEV</b> (MD)
<b>KITTY</b> (RC) 👁️ ABLOY (4)
<b>K+K</b> (I) 👁️ TAMPALINI (164)
<b>KKL</b> (A) WB
<b>KMF</b> (GR)
<b>KNAPP</b> (D) 👁️ CES (41-42)
<b>KNAUS</b> (GB) 👁️ EURO LOCKS (71)
<b>KOBE</b> (RUS)
<b>KOPAT</b> (YU)
<b>KÖNIG</b> (D) 👁️ VIRO (186)
<b>KOVER</b> (D) 👁️ EMKA (69)
<b>KP</b> (RUS)
<b>KRAMATORSK</b> (UA)
<b>KREMENCHUK</b> (UA)
<b>KROST</b> (D) 👁️ BUS (39)
<b>KUNERT</b> (D) 👁️ CISA (50)
<b>KURZEMES</b> (LV) 👁️ AISPUTE (12)

PER: FOR:	KKL	KMF	KOBE	KOPAT

PER: FOR:	KP	KRAMATORSK	KREMENCHUK



# 108

**PER / FOR**

**KVR (D)**  
CAP  
PROTEC

**KWIKSET (USA)**  
BRICARD  
E-Z-SET  
MASTER  
VACHETTE

**KYNNARPS (GB)**

**KYR (I)**  
SECURITAL (153)

**LABOFA (NL)**  
GEGE (85)

**LADA (RUS)**

**LA FONTE (BR)**

**PER: FOR: KVR**

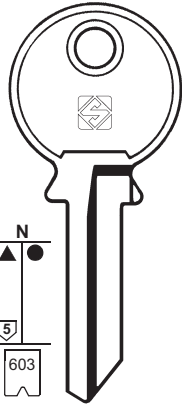

N  
▲ ●  
5

603

... 1576-1725



**CA9**

**CAP - PROTEC**

**PER: FOR: KWIKSET**

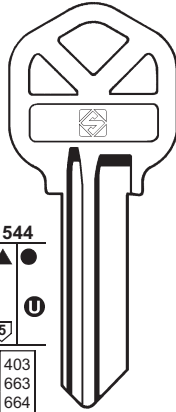

544  
▲ ●

U

5  
403  
663  
664



**KS1**

0-1-2-3-4-5-6-7  
1-2-3-4-5-6-7  
1-2-3-4-5-6-7-8-9

**BRICARD - E-Z-SET - MASTER - VACHETTE**

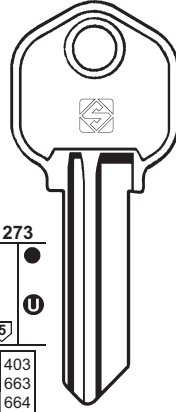

273  
▲ ●

U

5  
403  
663  
664



**KS1FT**

0-1-2-3-4-5-6-7  
1-2-3-4-5-6-7  
1-2-3-4-5-6-7-8-9

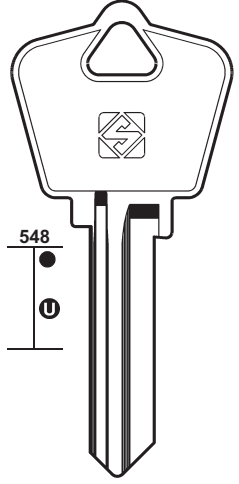

548  
▲ ●

U



**KS4**

**PER: FOR: KYNNARPS**

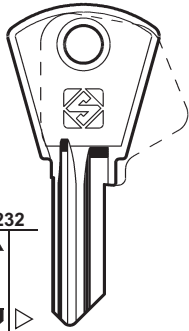

232  
▲

5

474

... 201-250



**KNA1**

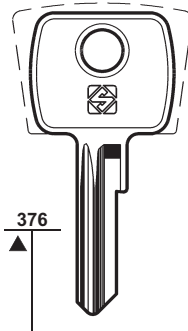

376  
▲



**KNA2**

**PER: FOR: LADA**

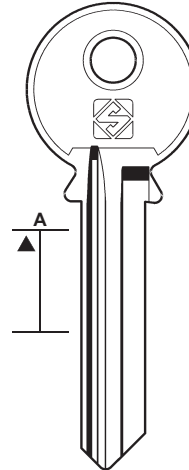

A  
▲



**LD4**

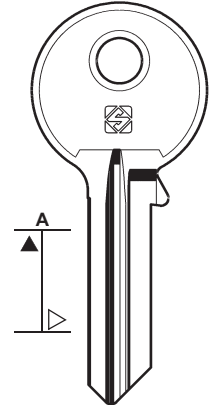

A  
▲



**LD4R**



**LD5R**

**PER: FOR: LA FONTE**

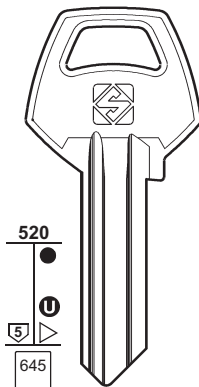

520  
▲ ●

5

645

... 1-2-3-4-5-6



**LAF1**

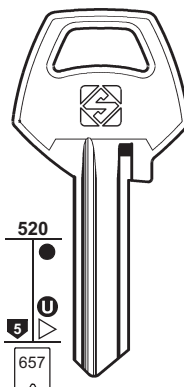

520  
▲ ●

5

657

... 1-2-3-4-5



**LAF2**

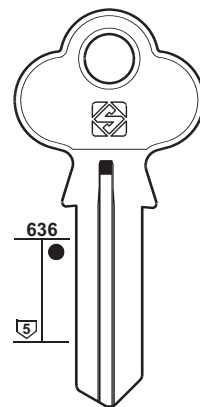

636  
▲ ●

5



**LAF4R**

PER:  
FOR:

# LA FONTE

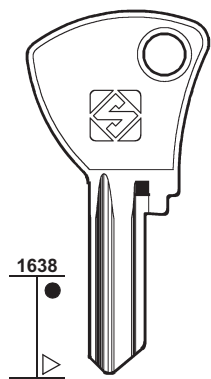

**LAF5**

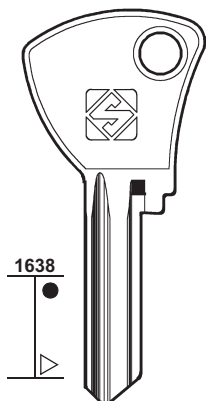

**LAF6**

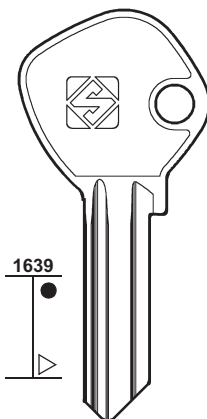

**LAF7**

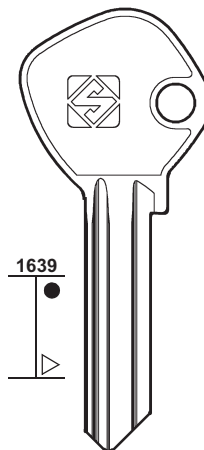

**LAF8**



# 109

PER / FOR

**LA FONTE** (BR)

**LAGRANGE** (USA)  
ILLINOIS (96)

**LAMA** (YU)  
+ MERONI (123)  
+ TITAN (167)

**LAMPA** (USA)  
CEMA (41)

**LANE** (AUS)  
CORBIN (54)

**LAPERCHE** (F)  
+ CAS-CISMA (40)  
+ DOM (63)  
+ RONIS (146-147)

PER:  
FOR:

# LAMA

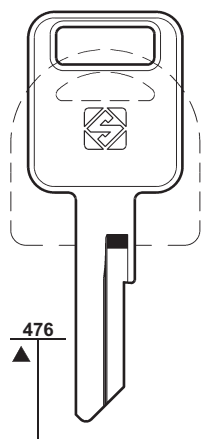

**LMA1**



# LAPERCHE

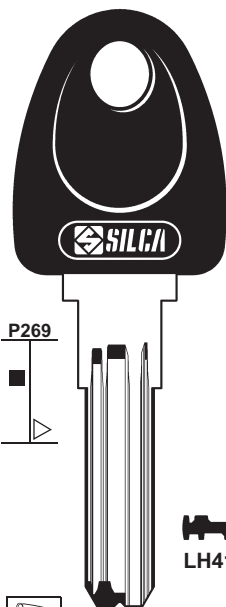

**LH41P**

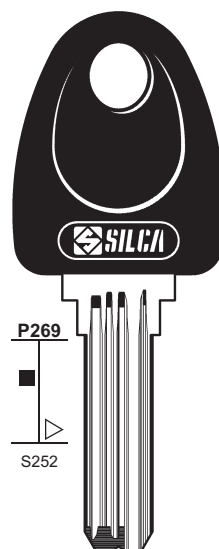

PER:  
FOR:

# LAPERCHE

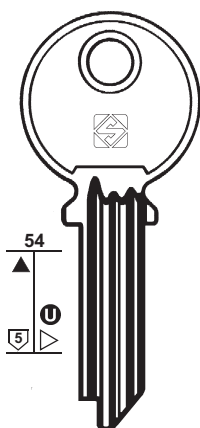

**LH1**  
DM

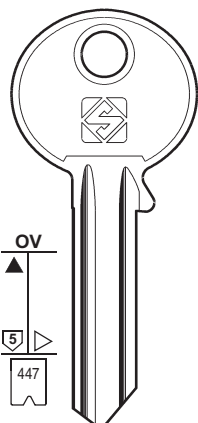

**LH4**

- C0 ..... 1-1000
- C1 ..... 1-1000
- C2 ..... 1-1000
- C3 ..... 1-1000
- B0 ..... 1-1000
- B1 ..... 1-1000
- B2 ..... 1-1000
- B3 ..... 1-1000

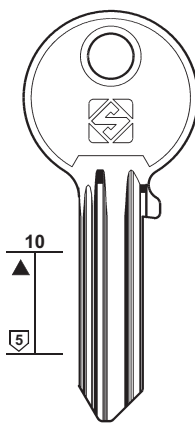

**LH40**

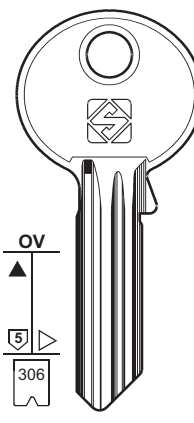

**LH42**

- L0 ..... 1-9999



# 110

### PER / FOR

#### LAPERCHE (F)

- + CAS-CISMA (40)
- + DOM (63)
- + RONIS (146-147)

#### LA PORTE (D)

- DLP
- GHE
- PRESTA
- + BOMORO (33)
- + DLP (59)

#### LAREDO (E)

- + YALE (193)

#### LARK (RC)

- + GLOBE (87)

#### LAS (F)

- ATAL
- DUBOIS
- HÄFELE
- KIFERM
- MARCADET
- PK
- RENZ
- RONIS
- STRAFOR
- WESCO
- + KIFERM (106)
- + RICOUARD (146)

PER:  
FOR:

## LAPERCHE

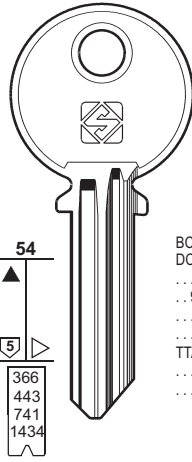

**LH5**  
..... 0-1-2-3-4-5-6-7-8-9  
..... 1-2-3-4-5-6-7-8-9  
TTP ..... 0-1-2-3-4-5-6-7-8-9  
... 9 ... 1-2-3-4-5-6-7-8-9

**LH5R**

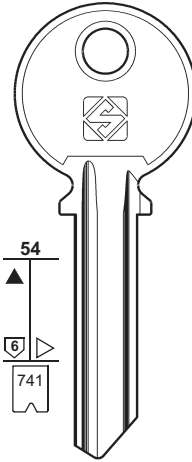

**LH10**  
..... 0123456789  
UUP .....  
0123456789

**LH10R**

**LH2**  
BC ..... 1001-3865  
DC ..... 1001-3865  
..... 1-2-3-4-5-6-7-8-9  
... 9 ... 1-2-3-4-5-6-7-8-9  
..... 15001-16000  
..... 16001-18125  
TTA ..... 0-1-2-3-4-5-6-7-8-9  
..... 13001-13500  
..... 1001-3865

**LH7R**  
..... 1-2-3-4-5-6-7-8-9

**LH20**  
..... 0-1-2-3-4-5-6-7-8-9  
TTR .....  
0-1-2-3-4-5-6-7-8-9

**LH21**  
..... 0-1-2-3-4-5-6-7-8-9  
TTS .....  
0-1-2-3-4-5-6-7-8-9

**LH22**  
..... 0-1-2-3-4-5-6-7-8-9  
TTT .....  
0-1-2-3-4-5-6-7-8-9

**LH23**

**LH24**

**LH25**  
UUR .....  
0-1-2-3-4-5-6-7-8-9

**LH26**  
UUS .....  
0-1-2-3-4-5-6-7-8-9

**LH28**  
UUV .....  
0-1-2-3-4-5-6-7-8-9

**LH27**  
UUT .....  
0-1-2-3-4-5-6-7-8-9

**LH29**  
UUX .....  
0-1-2-3-4-5-6-7-8-9

PER:  
FOR:

## LA PORTE

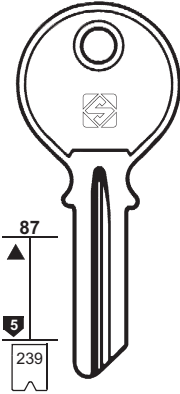

..... 7200-7399  
..... 1001-1052

**LAP1**

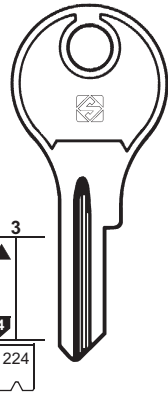

..... 2501-2550

**DL1R**

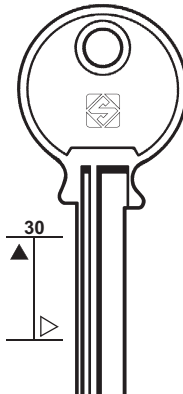

**LAP3**

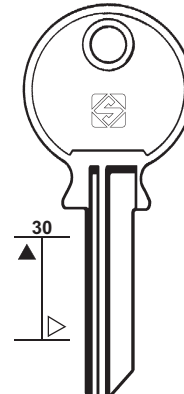

**LAP2**

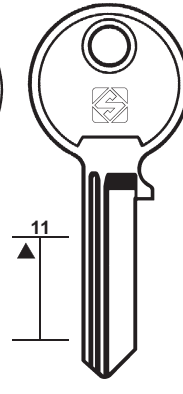

**DL3**

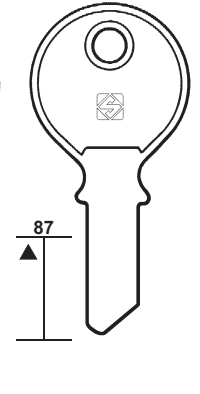

**DL2**

GHE - PRESTA

DLP

PER:  
FOR:

## LAS

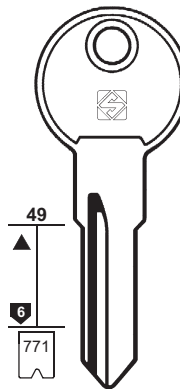

**LS3**  
A ... 1-650

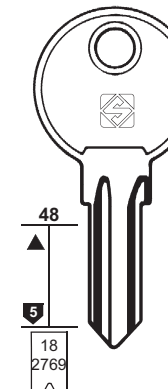

**LS1**  
R ... 1-224  
V ... 1-224

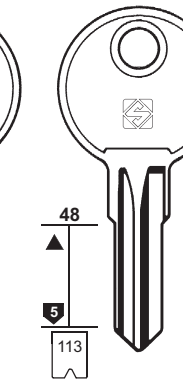

**LS1R**  
V ... 1-224

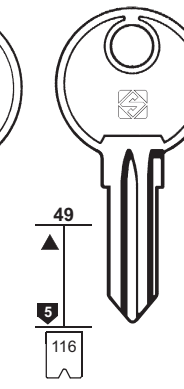

**LS2**  
AX ... 1-224

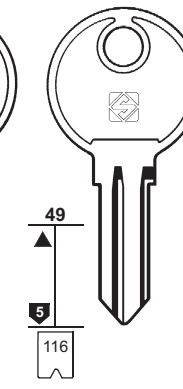

**LS7**  
FH ... 1-400  
LH ... 1-400  
FH ... 501-550

**LS19**  
FH ... 1-400  
LH ... 1-400  
FH ... 501-550

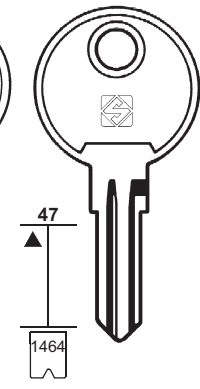

**LS12**  
LS ... 1-60

**LS10**  
AB

DUBOIS - KIFERM  
PK - RENZ  
RONIS - WESCO

ATAL - HÄFELE  
KIFERM

MARCADET - RENZ

**LS4**  
U

**LS4R**  
X

STRAFOR

PER: **LAS**  
FOR:

**LS5**  
L  
47

**LS6**  
L231  
47

**LS9**  
AT ... 1-650  
401  
6  
545  
206

**LS9R**  
TA ... 1-650  
PR

**LS11**  
RM ... 1-2000  
KT ... 3001-4000  
KT ... 7001-8000  
MARCADET - RONIS

**LS11R**  
TK ... 4001-5000

**LS13**  
JH ... 1-100  
FH ... 1-400  
LH ... 1-400  
SH ... 1-400  
WH ... 1-400  
AA ... 1-50  
LH ... 1-60  
... 301-675  
FH ... 501-500  
FORT

**LS14**  
MJ ... 1-400  
FM ... 1-100  
SM ... 1-400  
MR ... 001-050  
FM ... 501-550  
SM ... 501-550

**LS14R**

**LS15**  
403  
116

**LS17**  
PR

**LS18**  
PM ... 1-10  
ABBES - ORDO

**LS13R**  
FM  
SH ...  
501-550



111

PER / FOR

**LAS (F)**  
 ABBES  
 FORT  
 MARCADET  
 ORDO  
 RONIS  
 + KIFERM (106)  
 + RICOUARD (146)

PER: **LÅSBOLAGET**  
FOR:

**LEGALLAIS**

**LB11**

**LB10**

**LB19**

**LB18**

**LB23**

**LB22**

**LB33**

**LB32**

**LB35**

**LB34**

**LB28**  
6543210  
405  
4  
590

**LB29**

**LB29**

**TANLOCKS**

**TANLOCKS**  
288  
5  
591  
X09876V

**LEA1**  
210  
6  
S905  
1-2-3-4-5-6  
HB

**LÅSBOLAGET (S)**  
 TANLOCKS  
 + KABA (102)  
 + SIS (156)

**LAUDON (RSA)**  
 L & F (117)

**LBLM (E)**  
 FORTIS (81)

**LE FEBURE (USA)**  
 CIFIAL (47)

**LEGALLAIS (F)**  
 HB

**LEGGE (GB)**

**LEHEMANN (D)**  
 MLM (127)

**LEN-LOK (AUS)**  
 ROLL-A-DOOR  
 + LOCKWOOD (115)

**LG (F)**  
 ARROW (18)

PER: **LEGALLAIS**  
FOR:

**LEGGE**

**LEN-LOK**

**LEA2**  
11  
5

**LEG1**  
54  
5  
415  
1-2-3-4-5-6-7

**LEG2**  
66  
5

**LEG3**  
PASSEPARTOUT

**LL1**  
LL  
462  
ROLL-A-DOOR



# 112

### PER / FOR

**LINCE (E)**  
ICSA  
+ ALPHA (15)

**LION (USA)**  
JUNKUNC (101)

**LIONA-LIOX (F)**  
RONIS (146)

**LIPS (NL)**  
+ DALWA (57)

PER:  
FOR:

## LINCE

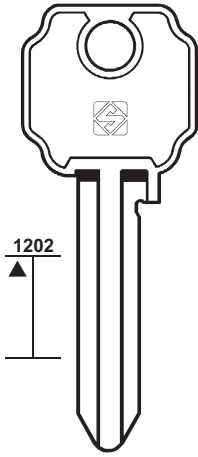

LC10  
K

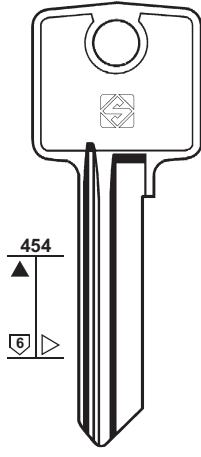

LC7 M LC7R M

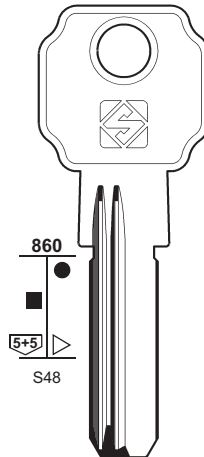

LC14R X  
ICSA

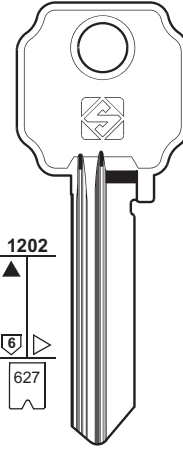

LC15 S LC15R S  
1-2-3-4-5-6-7-8

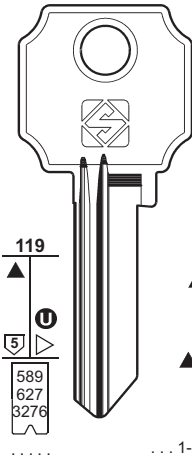

LC11 R  
1-2-3-4-5-6-7-8

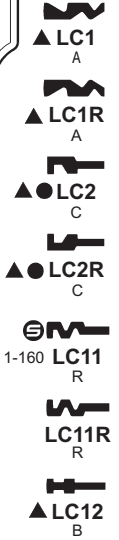

PER:  
FOR:

## LINCE

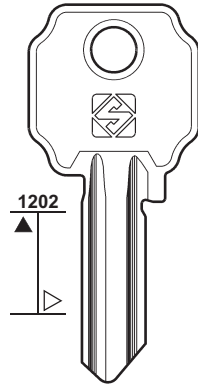

LC13 U

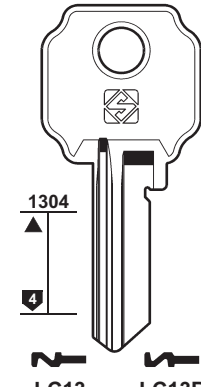

LC13 D1 LC13R D1

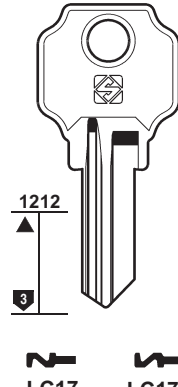

LC17 LC17R

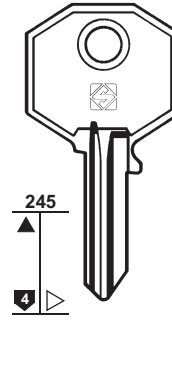

LC9R

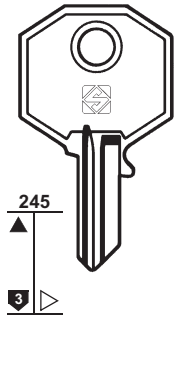

LC6 J LC6R J

LC5 F LC5R F

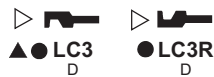

LC8 T LC8R T LC3 D LC3R D



LC4 E LC4R E

mm 30-40

mm 25

mm 20

PER:  
FOR:

## LIPS

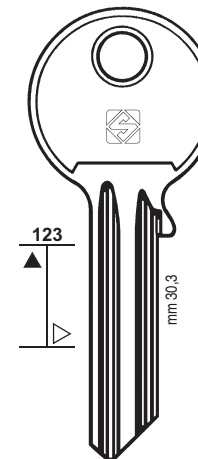

LP12 22 LP12R 25



LP8 39 LP8R 41 LP2 29 LP2R 34

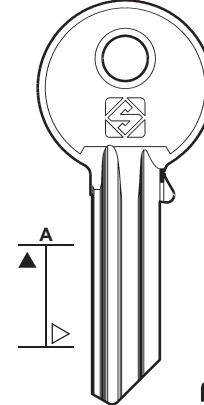

LP13 23 LP13R 26



LP7 40 LP7R 42 LP5 30 LP5R 35

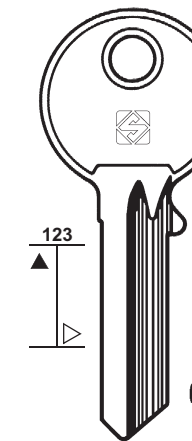

LP17R A



LP18R B LP19R D

LP38R 34D

LP36R 34B

LP35R 34A

LP20R 35C



PER:  
FOR:

# LIPS

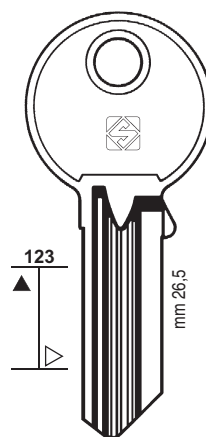
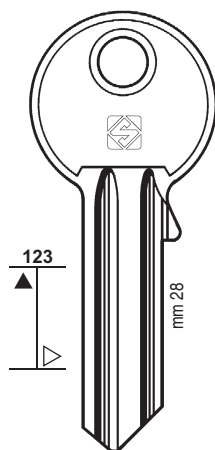
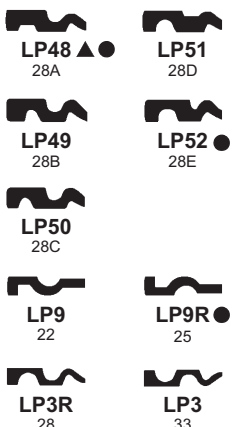
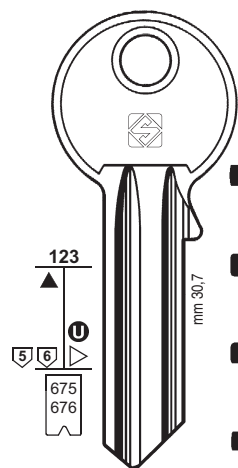

.....  
1-2-3-4-5-6-7-8-9-0  
A-B-C-D-E-F-G-H-I-L



# 113

PER / FOR

**LIPS (NL)**  
+ DALWA (57)

**LIPS-VAGO (I)**  
+ PREFER (143)

**LISTA (D)**  
+ DOM (62)

**LITTO (B)**  
ANKERSLOT  
BKS  
CORBIN  
+ ANKERSLOT (16)  
+ CORBIN (53)

PER:  
FOR:

# LIPS

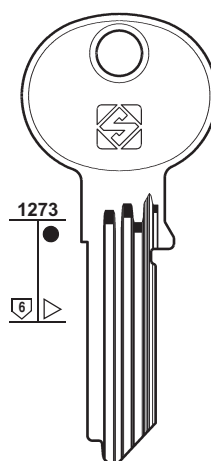
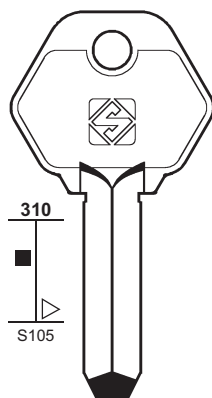
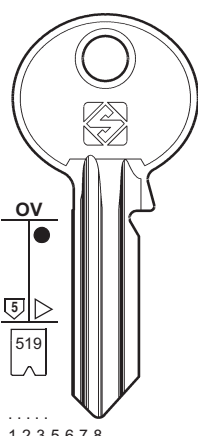
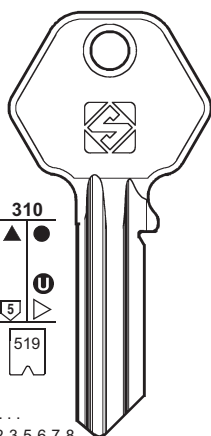

.....  
1-2-3-5-6-7-8

.....  
1-2-3-5-6-7-8



PER:  
FOR:

# LIPS

# LITTO

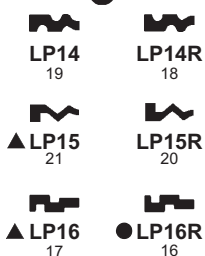
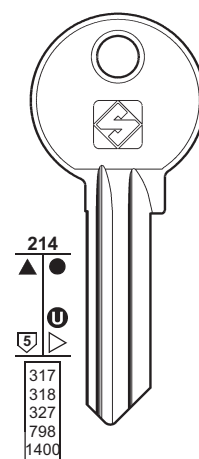
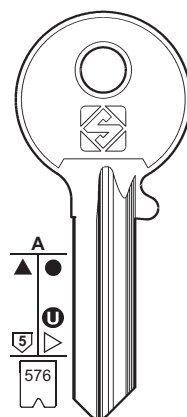
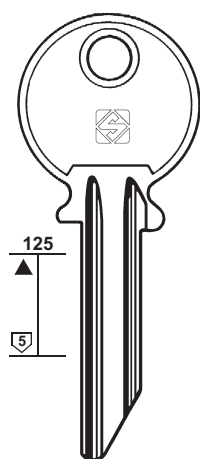
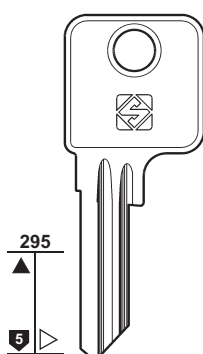
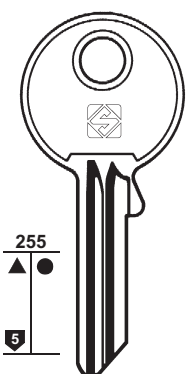

.....  
00E001-05E999  
.....  
1-2-3-5-6-7-8-9-0

..... 012345678  
..... 123456  
DX..... 123456  
..... 123456789  
..... 876543210

BKS

ANKERSLOT

CORBIN



# 114

### PER / FOR

**LITTO (B)**

+ ANKERSLOT (16)

+ CORBIN (53)

**LM (S)**

+ TEKA (165)

**L.M.C. (D)**

+ HUWIL (94)

**LML (I)**

+ MORI E. (128)

**LN (BR)**

**LOB (PL)**

+ BRICARD

+ EXPRES

+ REDY

+ ROSTEX

+ YETI

+ FAB (74)

+ MCM (121)

**LOCKSYS (BG)**

**LOCKWELL (BR)**

PER:  
FOR:

## LITTO

## LN

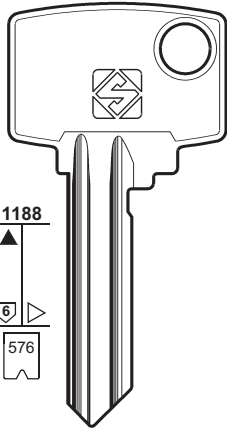

1188  
6  
576

LT3

.....1234567890

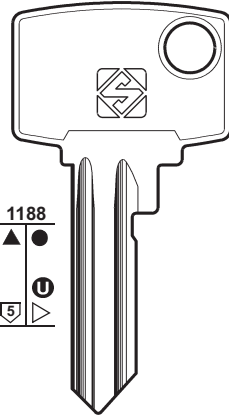

1188  
5

LT4

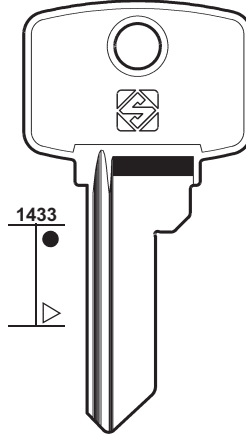

1433

LT5

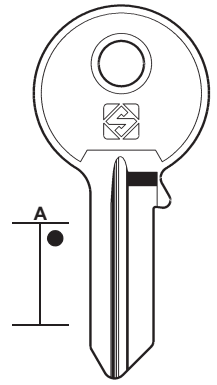

A

LN1

PER:  
FOR:

## LOB

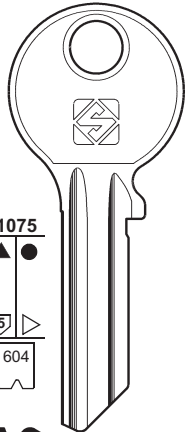

1075  
5  
604

YT16

YT15

.....0-1-2-3-4-5-6-7-8-9

BRICARD - EXPRES  
REDY - YETI

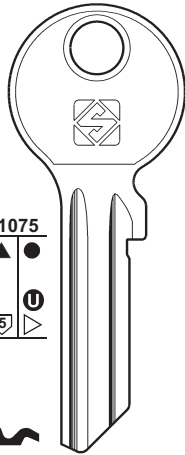

1075  
5

▲YT16X

YT15X

▲YT15RX

YETI

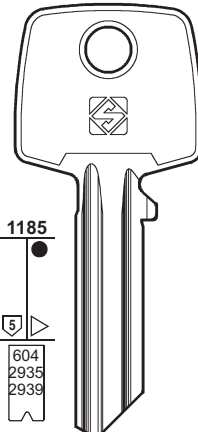

1185  
5  
604  
2935  
2939

LOB16

.....0123456789  
.....123456789ABC

YETI

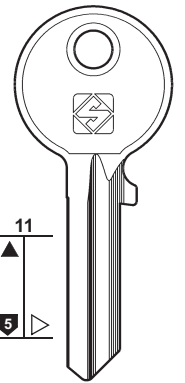

11  
5

LOB1

LOB1R

ROSTEX

PER:  
FOR:

## LOCKSYS

## LOCKWELL

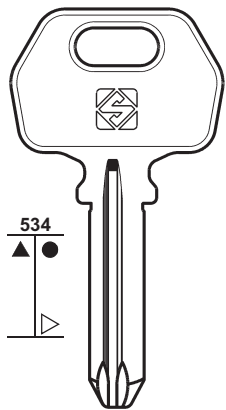

534

LCK1R

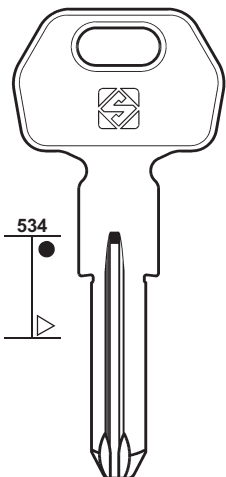

534

LCK1RX

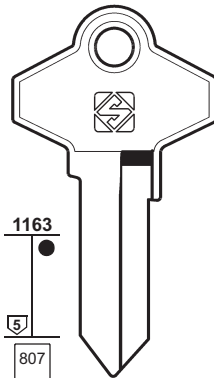

1163  
5  
807

LOC1

.....1-2-3-4-5-6-7-8

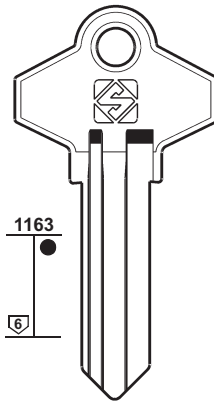

1163  
6

LOC3

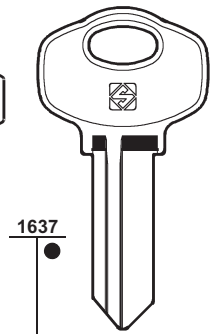

1637

LOC4

PER:  
FOR:

# LOCKWOOD

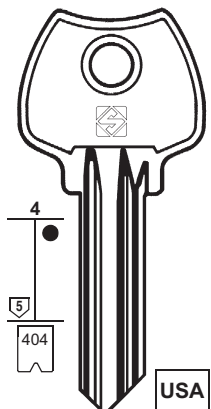

**LW1 ▲ LW1R**  
.....  
0-1-2-3-4-5-6-7-8-9

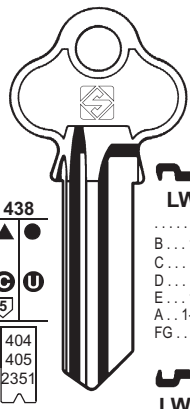

**LW20 ▲ LW20R**  
..... 0123456789  
X..... 100-27787  
HX..... 1000-1500

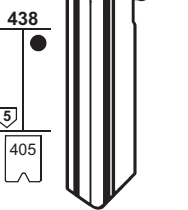
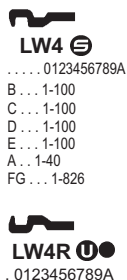

**LW40 ▲ LW40R**  
.....  
0-1-2-3-4-5-6-7-8-9-A

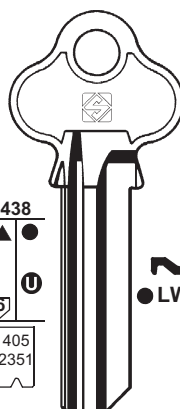

**LW5 ● LW5R ●**  
.....  
0123456789A  
B... 1-100  
D... 1-100  
F... 1-100  
A... 1-40  
C... 1-40

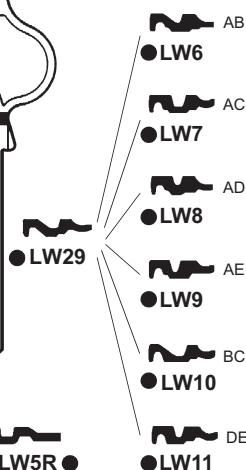

GAINSBOROUGH



# 115

PER / FOR

LOCKWOOD (AUS)  
GAINSBOROUGH

LOCKWOOD (AUS) (USA)  
LEN-LOK

PER:  
FOR:

# LOCKWOOD

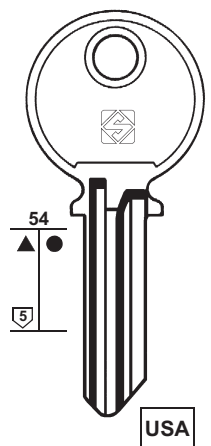

**LW2 ● LW2R ●**

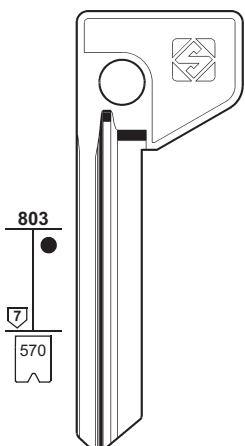

**LW21R**  
.....  
0-1-2-3-4-5-6-7-8-9-A

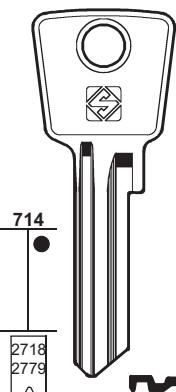

**LW28**  
..... 1-3720  
..... 3001-6720  
..... 456789A

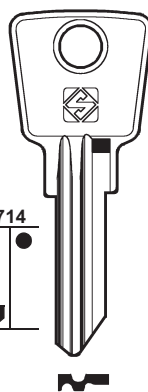

**LW14**  
24A

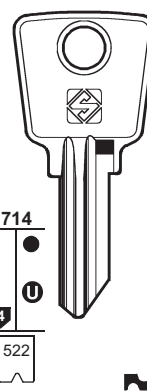

**LW3**  
..... 1-960  
L... 1-960  
L... 151-250

**LW13 ● LW12R ●**  
CL... 1-1000 Y... 1-960



PER:  
FOR:

# LOCKWOOD

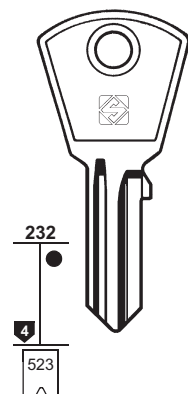

**LW15**  
..... 1-2100

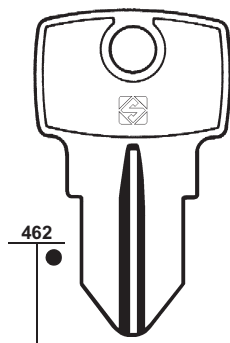

**LL1**  
LL

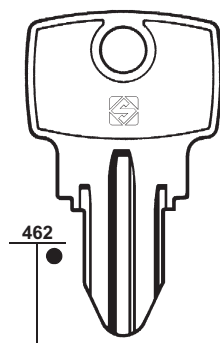

**LW16**  
R

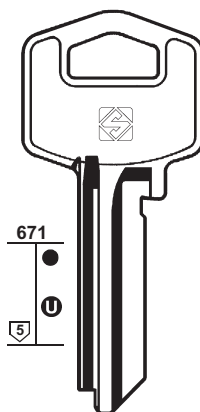

**LW17**  
N

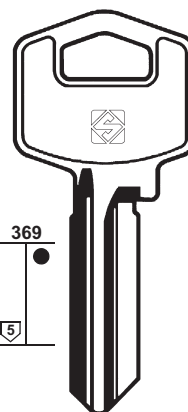

**LW18**

**LW19**



LEN-LOK



# 116

PER / FOR

**LOCKWOOD** (AUS) (USA)

**LOGO** (I)

CISA (48-50)

**LOK 2000** (I)

CISA (50)

**LORI** (USA)

EAGLE (67)

**LOTUS** (RC)

YETI (198-199)

**L & F** (GB)

ATAL  
DAD  
DOUBLE SAFE  
EURO LOCKS  
IBFM  
MIBRA  
TELFORD  
ULTRA  
UTZ

+ CHICAGO (46)

+ EURO LOCKS (71)

## LOCKWOOD

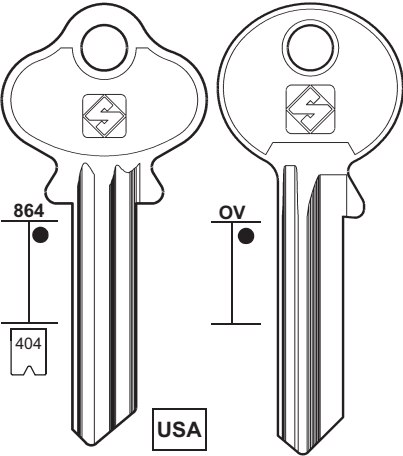

**LW23**

..... 0123456789

**LW24**

## LOWE & FLETCHER

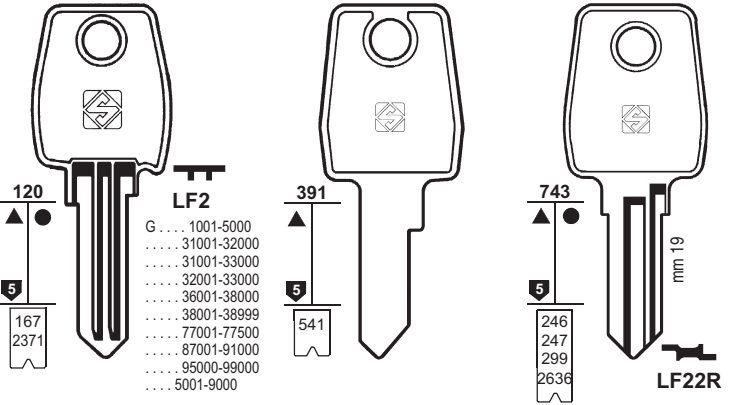

**LF2**  
G ... 1001-5000  
..... 31001-32000  
..... 31001-33000  
..... 32001-33000  
..... 36001-38000  
..... 38001-38999  
..... 77001-77500  
..... 87001-91000  
..... 95000-99000  
..... 5001-9000

**LF26**  
..... 77001-77500  
..... 95000-99000

**LF13**  
..... 2001-4000

**LF17**  
ATAL

**LF23R**  
EL ... 1-500  
..... 1001-1100  
93 ... 401-900  
..... 9001-9500  
EL ... 9001-9500

**LF22**  
93 ... 201-400  
..... 93901-94000

**LF16**

**LF16R**

**LF15R**  
..... 90901-90975

**LF57**

DOUBLE SAFE  
EURO LOCKS

DAD - MIBRA - UTZ

## LOWE & FLETCHER

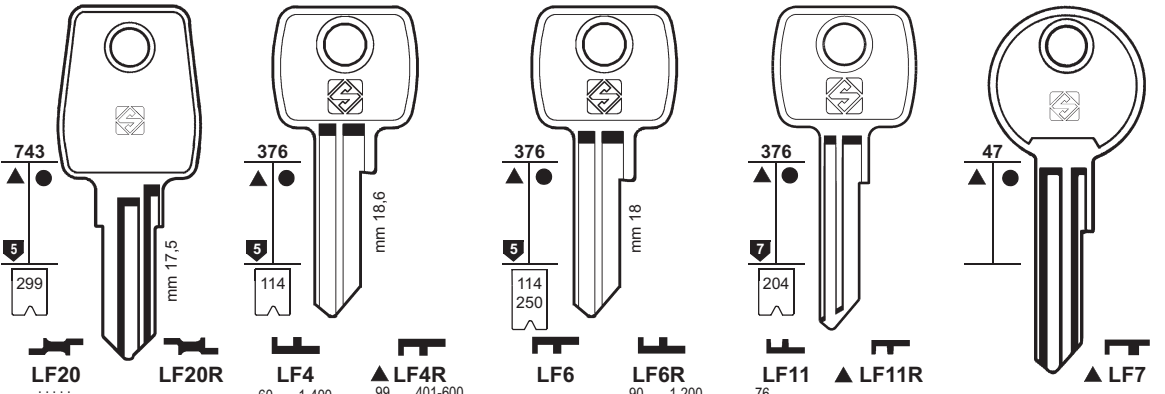

**LF20**  
..... 93901-94000

**LF20R**

**LF4**  
60 ... 1-400  
90 ... 1-200  
92 ... 1-400  
..... 1-400  
GHM ... 1-155  
M ... 1-400  
92 ... 401-600  
99 ... 1-400  
RV ... 1-400  
RVM ... 1-400  
SP ... 1-400  
GS ... 1-400  
... ES1  
... EV1

**LF4R**  
99 ... 401-600  
92 ... 501-700

**LF6**

**LF6R**  
90 ... 1-200  
..... 1-400  
91 ... 201-350  
GH ... 1-400  
SS ... 1-400  
92 ... 401-600  
GS ... 1-400

**LF11**

**LF11R**  
76 ...  
1-400  
.....  
70001-71200

**LF7**

**LF18R**

**LF42R**  
FFE ... 1-100  
NF ... 1-30

**LF52**

**LF8**

**LF8R**

UTZ

ULTRA

TELFORD

## LOWE & FLETCHER

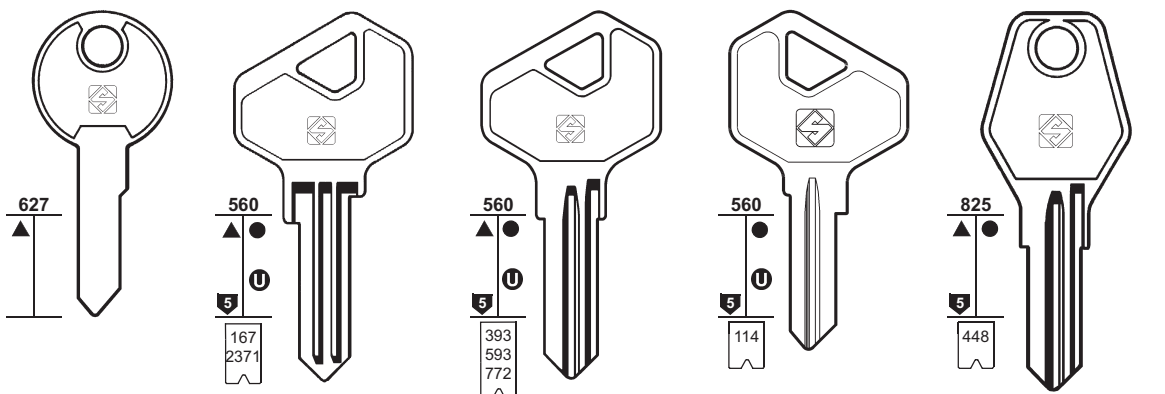

**LF29R**

**LF24**  
V ... 1-88  
E ... 101-600  
RE ... 101-600  
..... 5001-9000  
..... 31001-33000  
..... 36001-38000  
..... 87001-91000

**LF25**  
..... 14001-14088

**LF27**

**LF27R**  
..... 419001-419420  
19 ... 1-420  
..... 17001-19000  
..... 23001-23400  
..... 23001-25100  
..... 27001-27400  
..... 7001-7400  
..... 7001-9000  
..... 701-900  
..... 1-150

**LF43R**  
92 ... 601-800

**LF37**  
R ... 151-650  
T ... 1-1000  
S ... 1-1000  
..... 9001-9494



AUSTRALIA



AUSTRALIA



PER:  
FOR:

## LOWE & FLETCHER

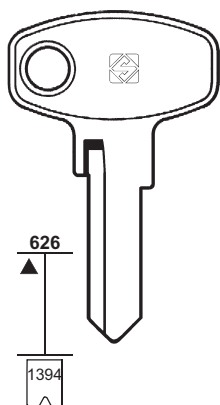

**LF28R**  
RO2...  
101-215

EURO LOCKS  
LAUDON

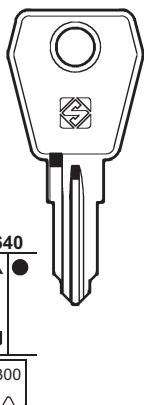

**LF30R**  
... 801-900  
... 901-1000

BASI - DAD

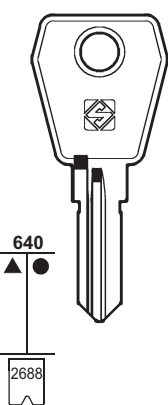

**LF61R**  
... 6601-7100

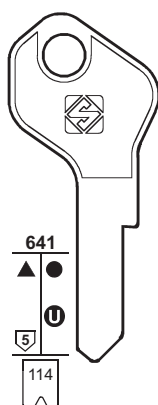

**LF31R**  
60... 001-400  
... 1-400  
92... 1-400  
M... 1-400  
91... 201-350  
... ES1  
... RV1

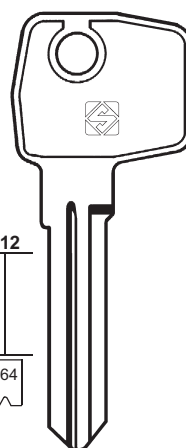

**LF33** 68001-70000

**LF51R**  
EURO LOCKS



# 117

PER / FOR

**L & F (GB)**  
BASI  
DAD  
EURO LOCKS  
LAUDON  
ROLL-A-DOOR  
+ CHICAGO (46)  
+ EURO LOCKS (71)

PER:  
FOR:

## LOWE & FLETCHER

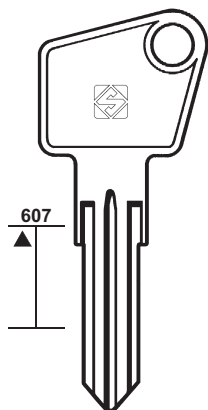

**LF34**

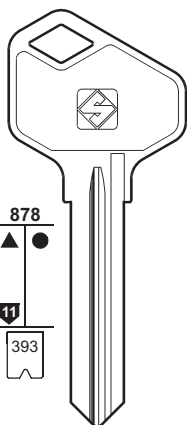

**LF39**  
09... 1-900  
29... 1-478

AUSTRALIA  
ROLL-A-DOOR

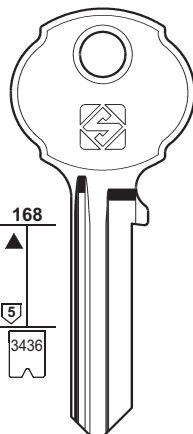

**LF47**  
A... 12000-13049

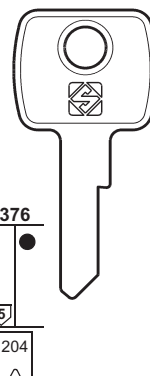

**LF54**  
75... 001-200

PER:  
FOR:

## LOWE & FLETCHER

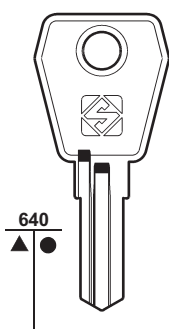

**LF46R**

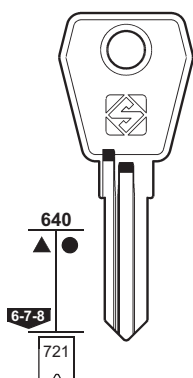

**LF45R** **LF53**  
ME... 001-300  
... 18000-18999  
... 19000-19999  
... 35000-35499  
... 78000-78999  
... 79000-79999

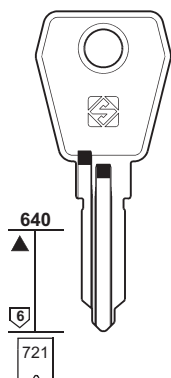

**LF58R** **LF59R**  
AA... 000-999

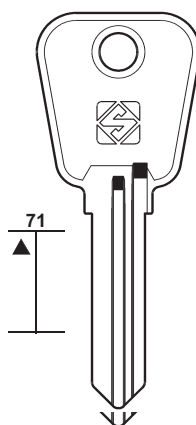

**LF56**

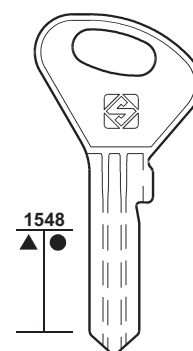

**LF60**



# 118

PER / FOR

**LOXEM** (GB)

**LR** (I)  
MORI E. (128)

**LUCO** (RC)  
GLOBE (87)

**LUCKY** (RC)

**LUMA** (E)

**LUME** (I)  
GIUSSANI (86)

**LUNA** (I)  
P.C. (CORTELLEZZI) (139)

**LUX** (ET)

**LYF** (E)

**M** (I)  
CAS-CISMA (40)

**MAFOR** (F)  
RONIS (146)

**MAQUET** (F)  
DOM (62)

**MARCADET** (F)  
LAS (110-111)

**MARCO** (D)  
DOM (62)

**MAGNUM** (I)

**MARIANI** (I)

**MARK** (RC)  
TRI-CIRCLE (173)

**MARLIN** (I)  
BOSS (33)

**MARS** (RC)

**MASTER** (USA)  
+ ABUS (8)  
+ KWIKSET (108)  
+ TOK-WINKHAUS (168)

PER: **LOXEM**

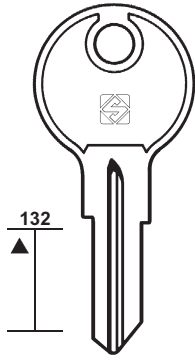

**LXM1R**



FOR: **LUCKY**

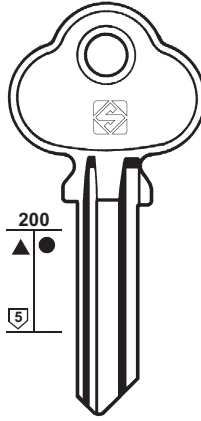

**LU1**

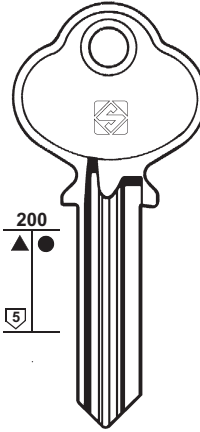

**LU2**

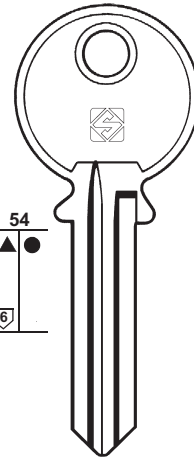

**LU3R**

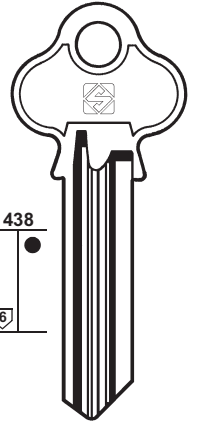

**LU4**

PER: **LUMA**

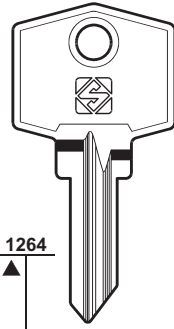

**LM3**

**LM3R**

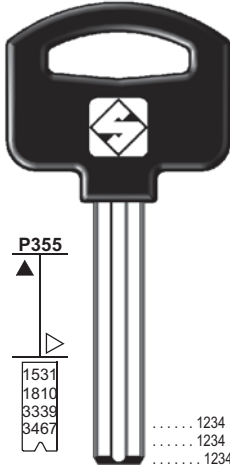

**LM4**

**LM4R**

**LM5P**



FOR: **LUX**

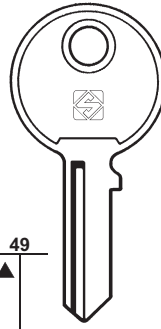

**LX1**

**LX1R**



**LYF**

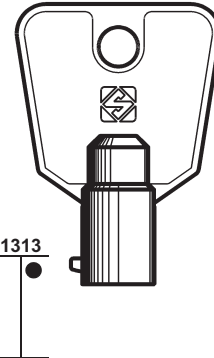

**LYF1T**

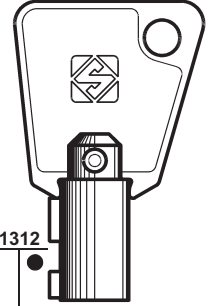

**LYF2T**



S536  
S818

..... 654321  
..... 76543210

PER: **MAGNUM**

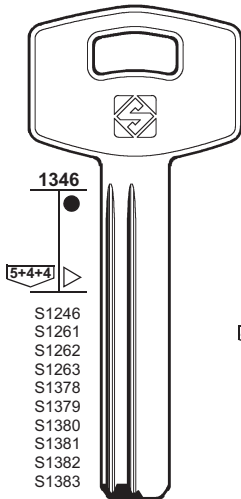

**MGN1R**

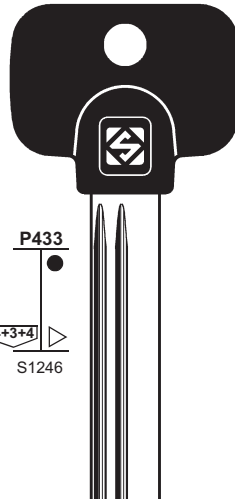

**MGN1RP**



FOR: **MARIANI**

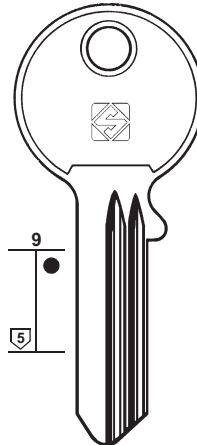

**MR1**

**MARS**

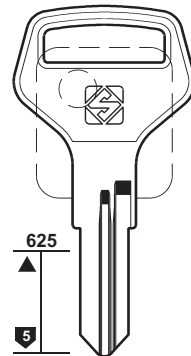

**MAR1**

**MASTER**

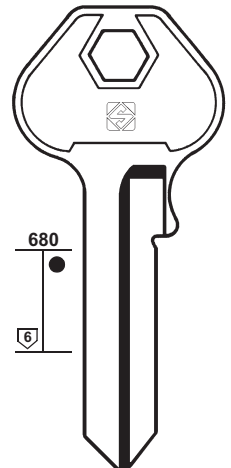

**MS8**



PER: **MASTER**  
FOR:

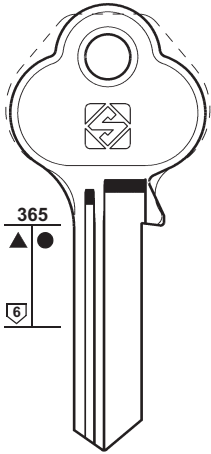

**MS19**

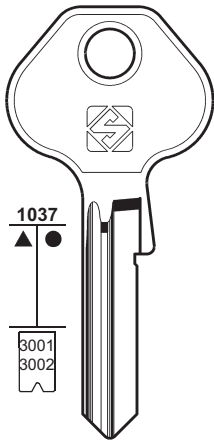

**MS17**  
..... 01234567  
410K ..... 001-999

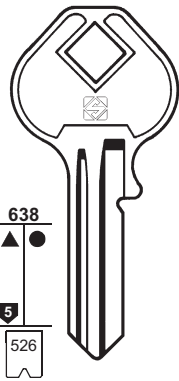

**MS6**

**MS5R**  
10T ..... 1-1000

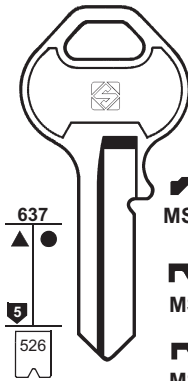

**MS13R**

**MS9R**

**MS4R**

..... 1-9800  
34H ..... 601-912

**MS3**

**MS3R**  
10L ..... 1-1000

**MS11**

**MS11R**

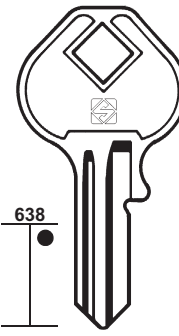

**MS10**



**119**

PER: **MASTER**  
FOR:

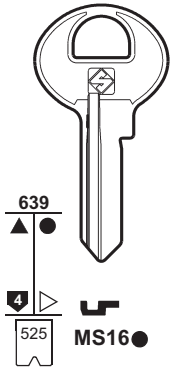

**MS16**

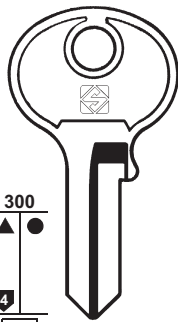

**MS7**

**MS1**

**MS12**

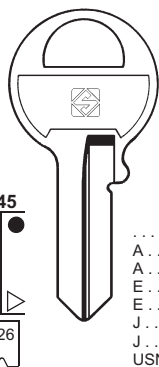

**MS2**

1K

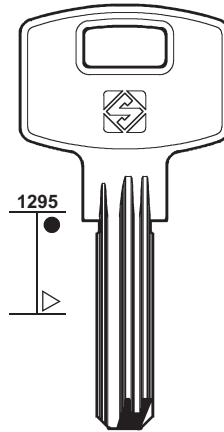

**MS23**

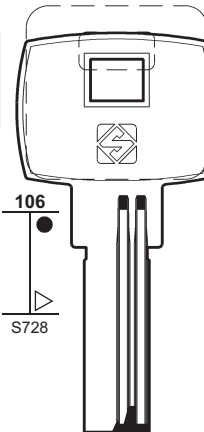

**MS22**

P ..... 1-850  
T ..... 1-3000  
X ..... 1-1500

**MS14**

mm 30

HAMPTON

..... 3201-4000  
A ..... 101-2100  
A ..... 5501-6400  
U ..... 1-3250  
X ..... 2001-3000  
X ..... 5001-6000  
M ..... 2001-4515  
J.U. .... 01-50

mm 40

HAMPTON

..... 1-3200  
A ..... 101-2100  
A ..... 5501-6400  
E ..... 1-700  
E ..... 2001-3000  
J ..... 301-1250  
J ..... 2001-2150  
USN ..... 1-4500  
W ..... 0-3500  
WO ..... 1-1000  
X ..... 2001-3000  
X ..... 5001-6000  
..... 4201-5000  
..... 5001-6000  
..... 6001-7000  
..... 7001-8000  
..... 8001-9000  
..... 9001-10000  
M ..... 2001-4515



PER: **MASTER**      **MASTER LOCK**      **MAUER**  
FOR:

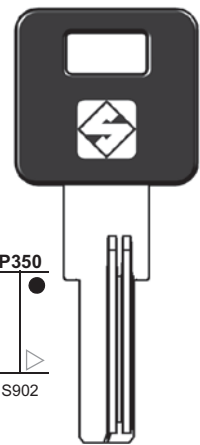

**MS20P**

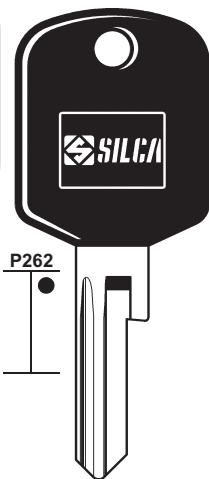

**MS21AP**

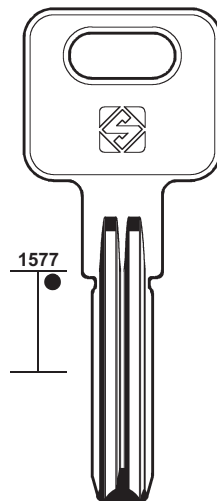

**MSL1**

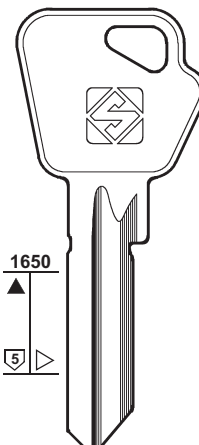

**MAU1R**

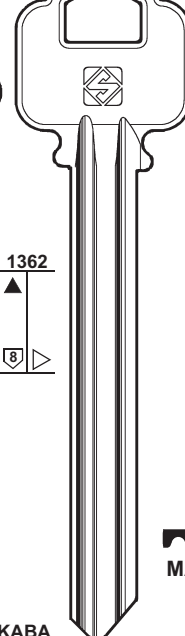

**MAU2**

DEKABA



# 120

PER / FOR

**MAUER LOCKS** (BG)  
DEKABA  
+ DEKABA (57)

**MAUSER** (D)  
 CES (42)  
 HOPPE (93)  
 HUWIL (94)

**MAXIGARD** (F)  
 GABON (84)

**MAXUS** (GB)

**MAY-TAY** (IL)

**MBB** (D)  
 CES (42)

**MCM** (E)  
MONDRAGON

PER: FOR:	MAUER	MAXUS	MAY-TAY
	 1362  1362 MAU3      MAU4 DEKABA	 1671 5 MXU1R	 1355 MAY1

PER: FOR:	MCM								
	 128 5 MC1	 129 5 6 U 595 749 MC1R	 129 5 6 MC2 1..... 1-2-3-4-5-6-7 ..... 0-1-2-3-4-5-6-7	 129 5 6 MC2R 1..... 1-2-3-4-5-6-7 ..... 0-1-2-3-4-5-6-7	 129 5 6 MC7	 129 4 MC5	 129 3 MC5R	 129 MC6	 129 MC6R
	MONDRAGON								

PER: FOR:	MCM					
	 129 5 U 3116 MC4	 454 7 6 748 750 MC4R	 459 MC3	 890 MC17	 890 MC8	 890 MC13
	MONDRAGON					



PER:  
FOR:

### MCM

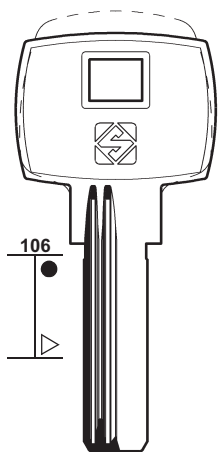

**MC14R**

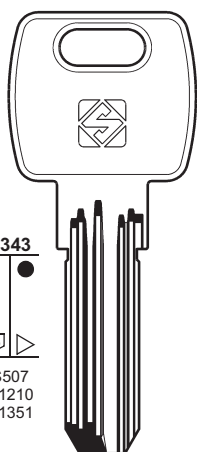

S507  
S1210  
S1351

..... 162-17HH6

**MC15R**  
E8

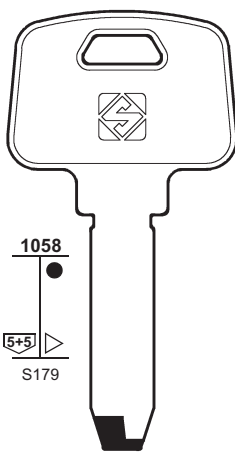

S179

**MC9X**  
4SS



LOB - YETI

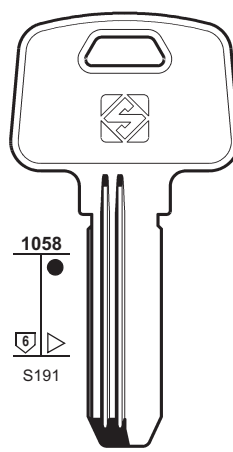

S191

**MC10R**  
4SE



TROMER



# 121

PER / FOR

**MCM** (E)  
LOB  
TROMER  
YETI

**MECALUX** (F)  
AGA (10)

**MECO** (D)

**MEDECO** (USA)

PER:  
FOR:

### MCM

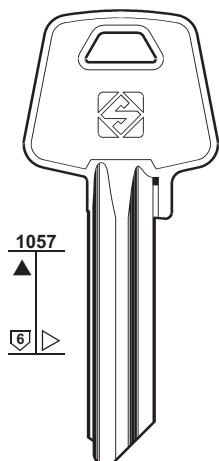

**MC11**  
X

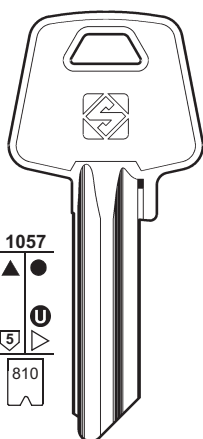

E..... 11241-79868  
X..... 123456789

**MC12**

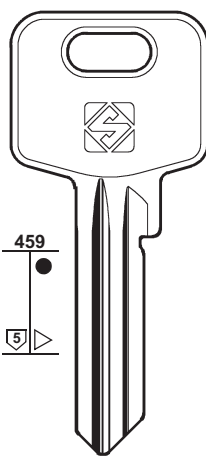

**MC18R**

B

**MC19R**

C

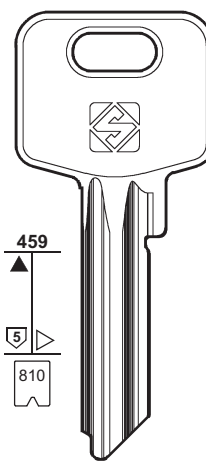

**MC20**

X..... 1234567890  
E..... 11241-79868

PER:  
FOR:

### MECO

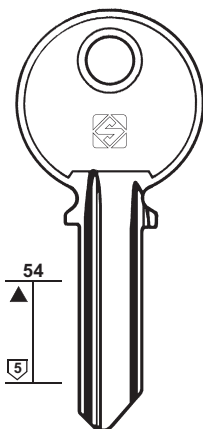

**MEC1**

### MEDECO

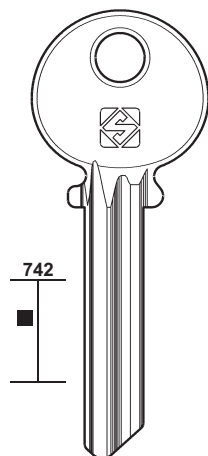

**MD4**

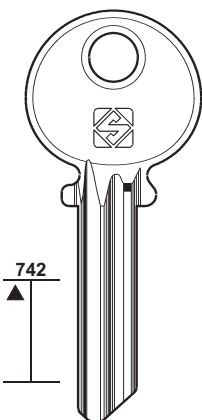

**MD7**

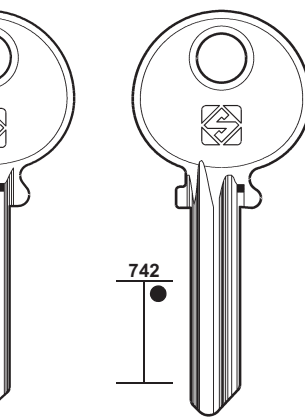

**MD11**

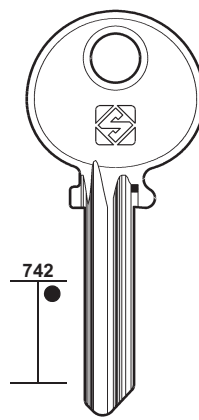

**MD6**

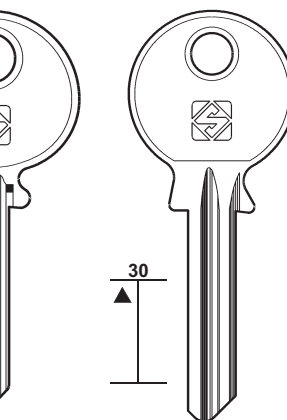

**MD8R**



**MD1R**



# 122

**PER / FOR**

**ME-FA (RC)**  
BRABANTIA  
CLAUSOR

**MEGA (RO)**

**MELSMETALL (D)**

BURG  
FARCE  
HBC  
KEYA  
SES  
+ BURG (37)

**MENOVA (D)**

DOM (61)

**MERCUR (D)**

JOWIL (100)

**MERLE (RA)**

**MERMIER (F)**

CORBIN (52-53)

**PER: ME-FA**

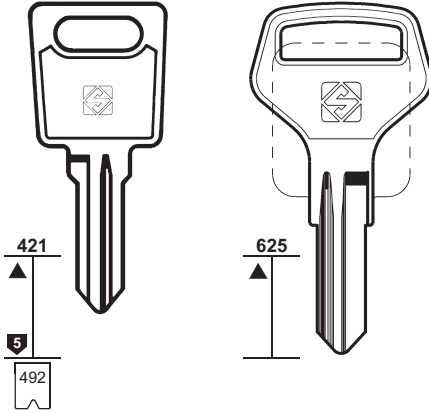

421  
5  
492

625

**MF1R**  
... 1-100  
... 101-200

**MFA1**



BRABANTIA - CLAUSOR

**PER: MEGA**

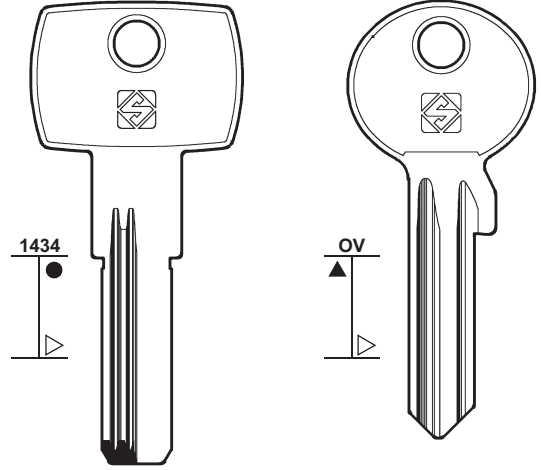

1434

OV

**MEG1R**

**MEG2**



**PER: MELSMETALL**

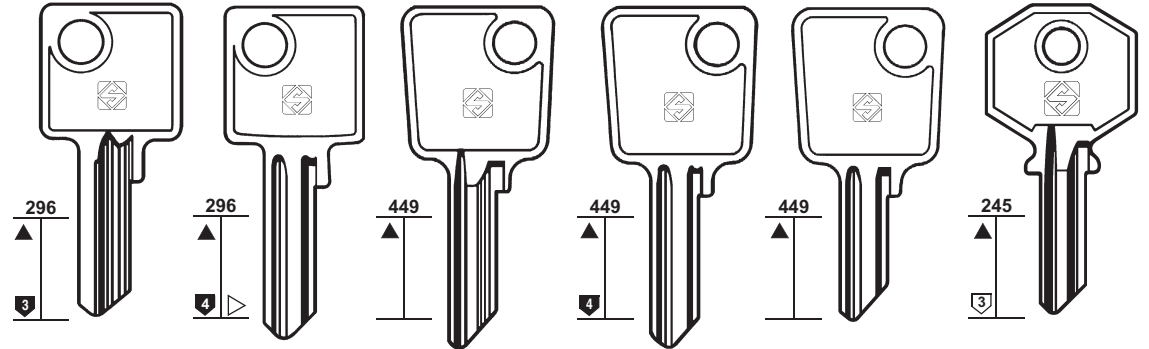

296  
3

296  
4

449

449  
4

449

245  
3

**ME1**

**ME3**

**ME6**

**ME7**

**BUR6**

**ME2R**

**ME8**

**ME4**

**ME4R**

**ME5**

**ME5R**

**BURG**



**HBC**



**PER: MELSMETALL**

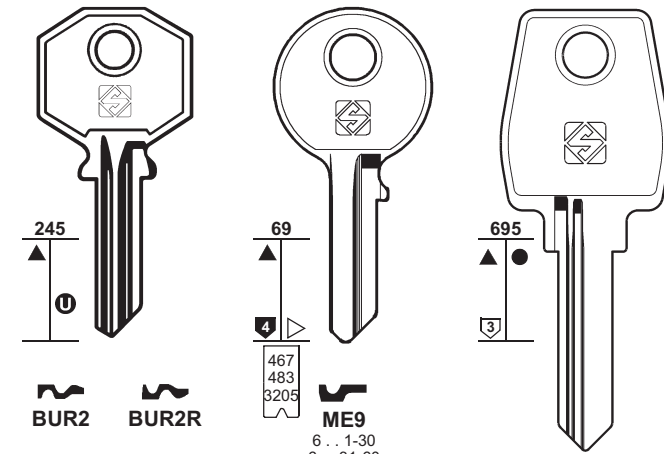

245  
1

69  
4

695  
3

**BUR2**

**BUR2R**

467  
483  
3205  
  
**ME9**  
6 ... 1-30  
6 ... 31-60  
..... 1234

**ME10R**



**BURG**



**FARCE - KEYA  
SES**

**PER: MERLE**

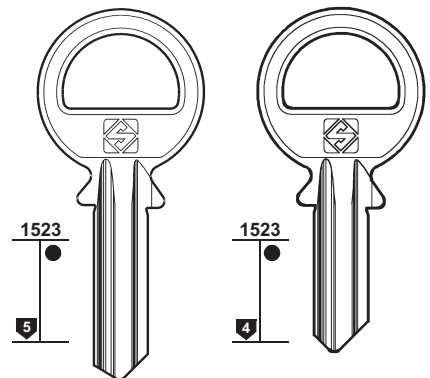

1523  
5

1523  
4

**MLE1**

**MLE2**

PER:  
FOR:

# MERONI

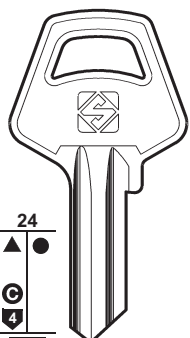

**MER1**

... 1001-1500

BIB - NOVOTECNICA



**MER1R**



LAMA

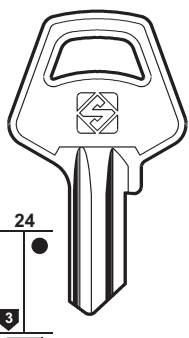

**MER27**

... T001-113  
... 1701-1810

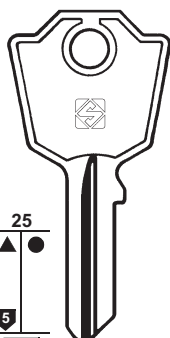

**MER4**

G ... 3001-3480  
G ... 0-479  
... 3001-3480



**MER4R**



LAMA

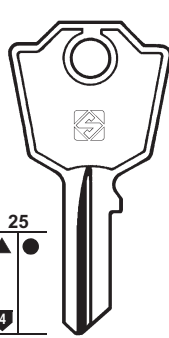

**MER5**

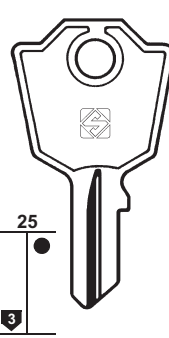

**MER6**



**MER6R**



# 123

PER / FOR

**MERONI (I)**  
BIB  
CAROLI  
LAMA  
NOVOTECNICA  
+ EVERGOOD (71)

PER:  
FOR:

# MERONI

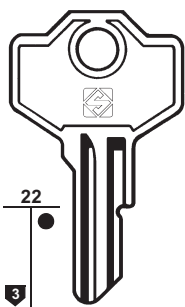

**MER7R**

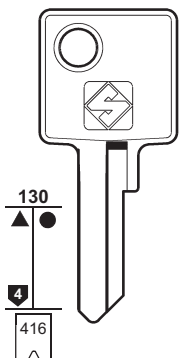

**MER2**

... 1-294  
... 301-400  
... 401-694  
... 941-975



CAROLI

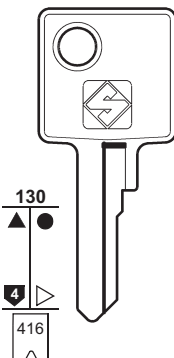

**MER24**

... 1-294

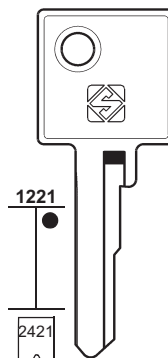

**MER29**

... 1-294  
... 301-400  
... 401-694  
... 941-975

PER:  
FOR:

# MERONI

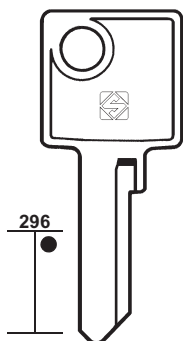

**MER23**  
PREMI-APRI

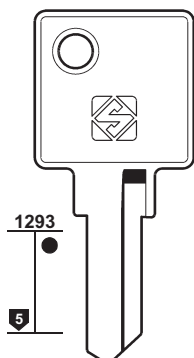

**MER31**

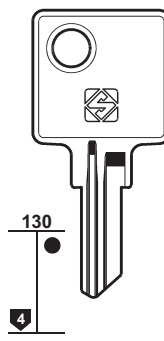

**MER32**



# 124

PER / FOR

**MERONI** (I)  
 EBA  
 IJ  
 JTF  
 MING-TAY  
 WINFOR  
 + EVERGOOD (71)

PER:  
FOR:

## MERONI

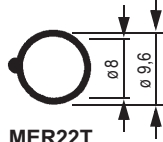
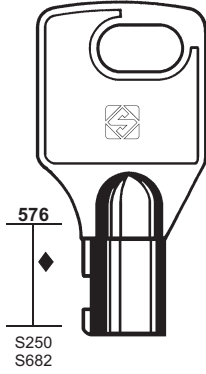

**MER22T**  
..... 543210

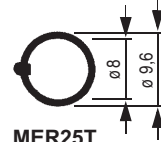
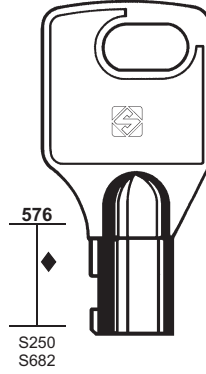

**MER25T**  
..... 543210

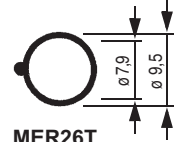
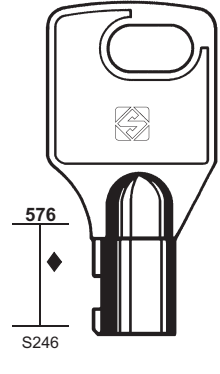

**MER26T**  
..... 10000-10998



MING-TAY - WINFOR

PER:  
FOR:

## MERONI

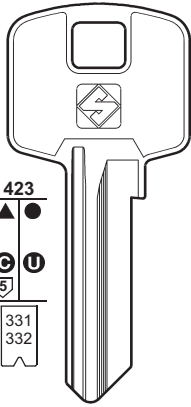

**MER8**

..... T  
 0-1-2-3-4-5-6-7-8-9  
 M.....  
 0-1-2-3-4-5-6-7-8-9  
 PREMI-APRI  
 EBA - IJ - JTF

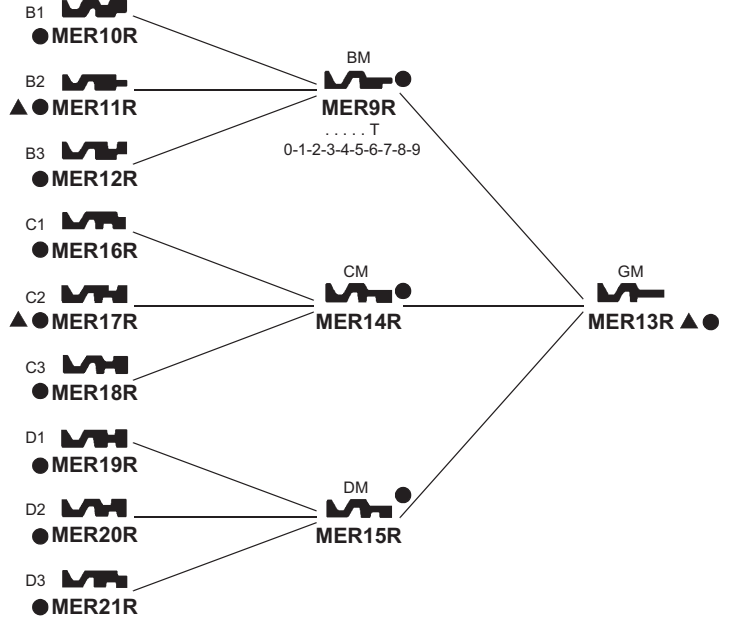

PER:  
FOR:

## MERONI

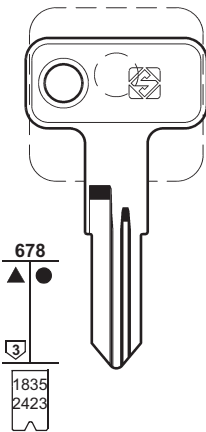

**MER33R**

... 0-1-2-3  
 ... 1-709  
 CB ... 1-709

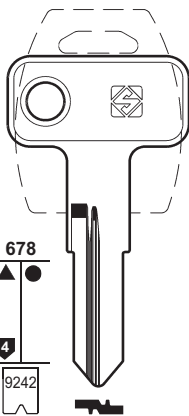

**MER34R**

CC ..... 4001-4650

**MER35R**

CD

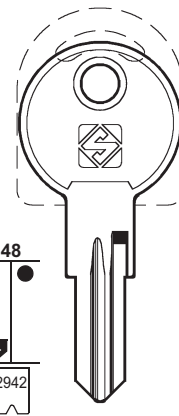

**MER36**

..... 1234

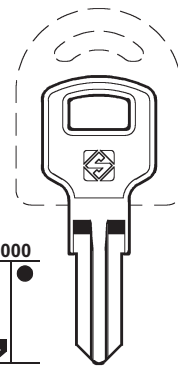



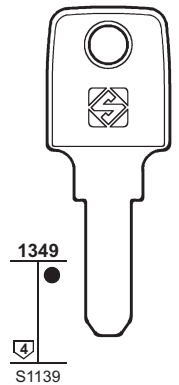





**MER37**

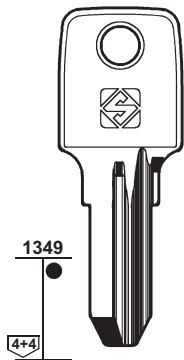
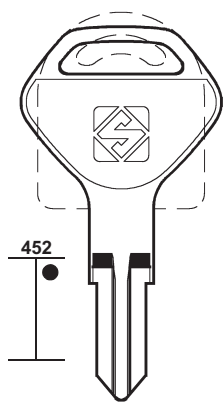
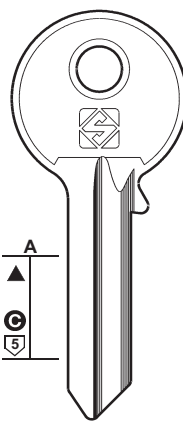
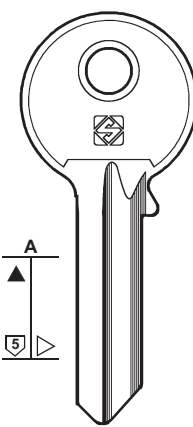

**MER39**







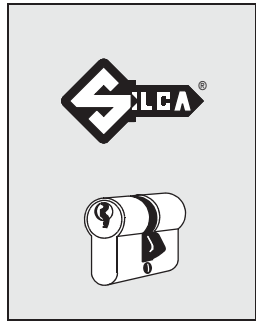



WA .....











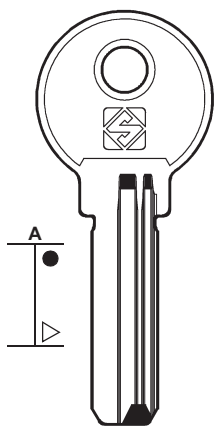
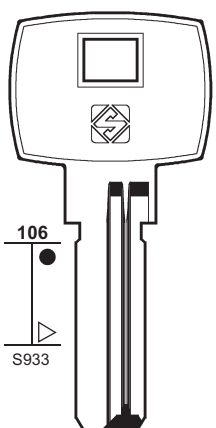
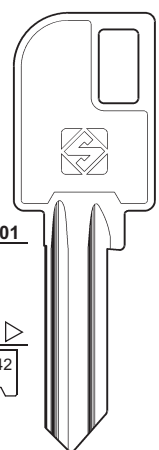
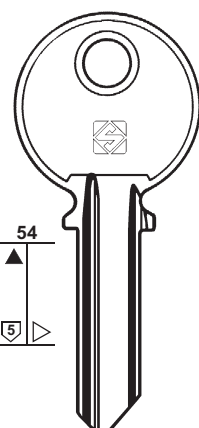





PER: FOR:	<b>MERONI</b>	PER: FOR:	<b>METAL</b>
	 1349  452		 A  A
	 <b>MER38</b> 		 <b>MTA1R</b> 
	 <b>MER41</b> 		 <b>MTA3R</b> 

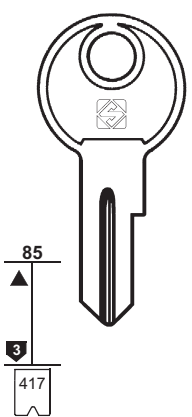
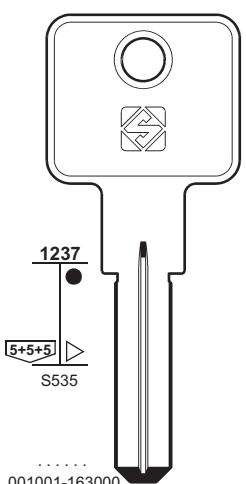
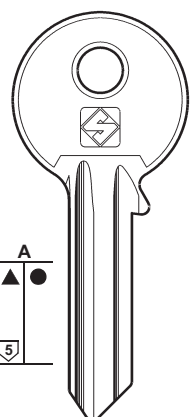
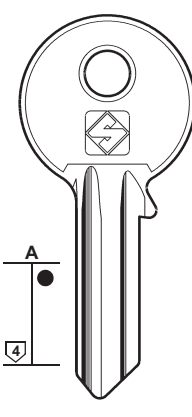
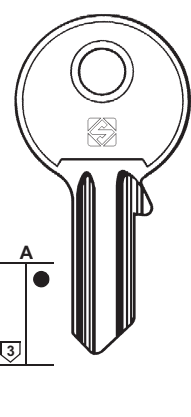

# 125

- PER / FOR**
- MERONI** (I)
  - +  EVERGOOD (71)
  - METAL** (BG)
  - +  OJMAR (134)
  - METALCASTELLI** (I)
  - +  GIUSSANI (86)
  - +  HEKNA (92)
  - +  PREFER (143)
  - METALUX** (F)
  - +  TESA (165)
  - +  VACHETTE (181)
  - METEOR** (F)
  - +  BKS (31)
  - +  DOM (61)
  - +  KIFERM (106)
  - METIZ** (UA)
  - +  KIEV (106)
  - MG (MONTI)** (I)

PER: FOR:	<b>METAL</b>	PER: FOR:	<b>METALUX</b>
	 A  106 S933		 1001  54 442
	 <b>MTA4</b> 		 <b>MX1</b> ..... 1001-2178 L ..... 1001-2178 ..... 1234567 L ..... 14001-14500 L ..... 15001-18199 ..... 20001-20625
	 <b>MTA2</b> 		 <b>MX5</b>

PER: FOR:	<b>METEOR</b>	<b>MG (MONTI)</b>					
	 85 417	 1237 S535 ..... 001001-163000	 A  A  A				
	 <b>MET1</b> B ... 1-600 G ... 1-600	 <b>MG8</b> PBA 	 <b>MG1</b>	 <b>MG1R</b>	 <b>MG2</b>	 <b>MG2R</b>	 <b>MG3</b>



# 126

PER / FOR

**MG (MONTI)** (I)

**MIAN-FORCE** (RC)

**GLOBE** (87)

**MIBRA** (GB)

**L & F** (116)

**MICHEL-SEAT** (I)

+ **O.M.R.** (136)

+ **POTENT** (142)

+ **SEAT** (152)

**MILA** (DK)

+ **EVO** (72)

**MILANO** (BR)

**MILES** (RUS)

**MING-TAY** (RC)

**SOS**

+ **MERONI** (124)

**MIPPART** (D)

**DOM** (62)

**MIT** (I)

**INDESIT** (96)

PER:  
FOR: **MG (MONTI)**

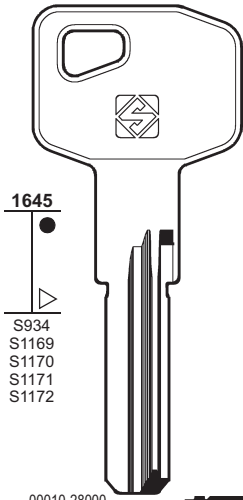

A5 ..... 00010-28000  
A6 ..... 00010-28000  
A7 ..... 00010-28000  
A8 ..... 00010-28000

**MG9**  
X8



**MICHEL-SEAT**

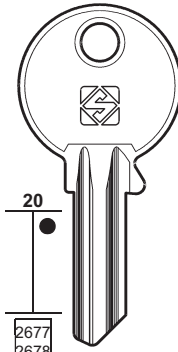

**MH1**  
... 201-436

**MH1R**  
... 437-672

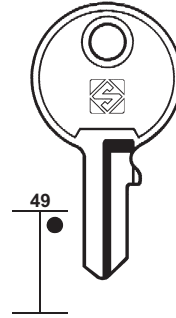

**SEA4**

**SEA4R**

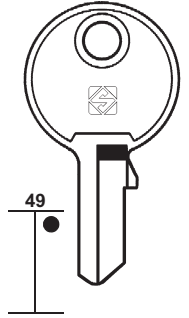

**MH5R**



PER:  
FOR: **MILA**

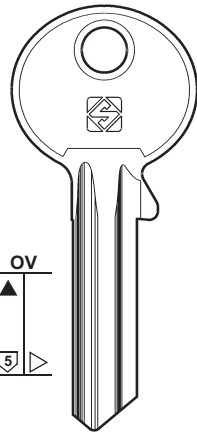

**MIL1**

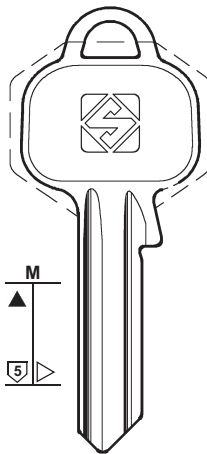

**MIL2**

**MILANO**

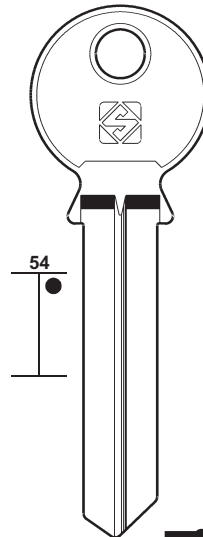

**MLN3**

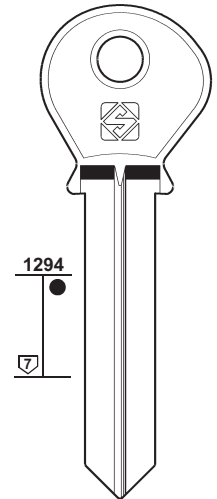

**MLN1**

PER:  
FOR: **MILES**

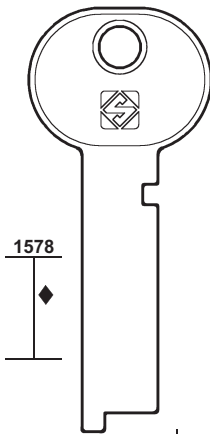

**MIS1**

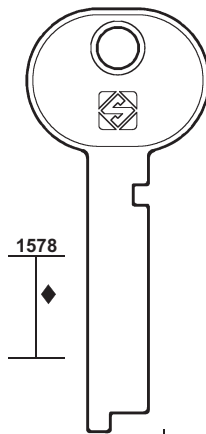

**MIS2**



**MING-TAY**

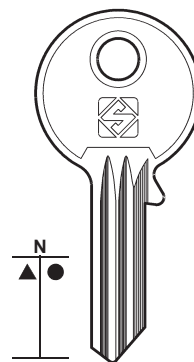

**MTY1**

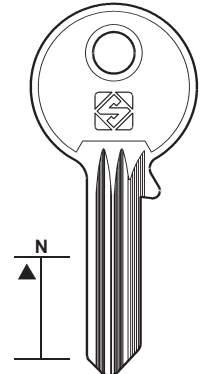

**MTY2**

**SOS**

PER: **MIWA**  
FOR:

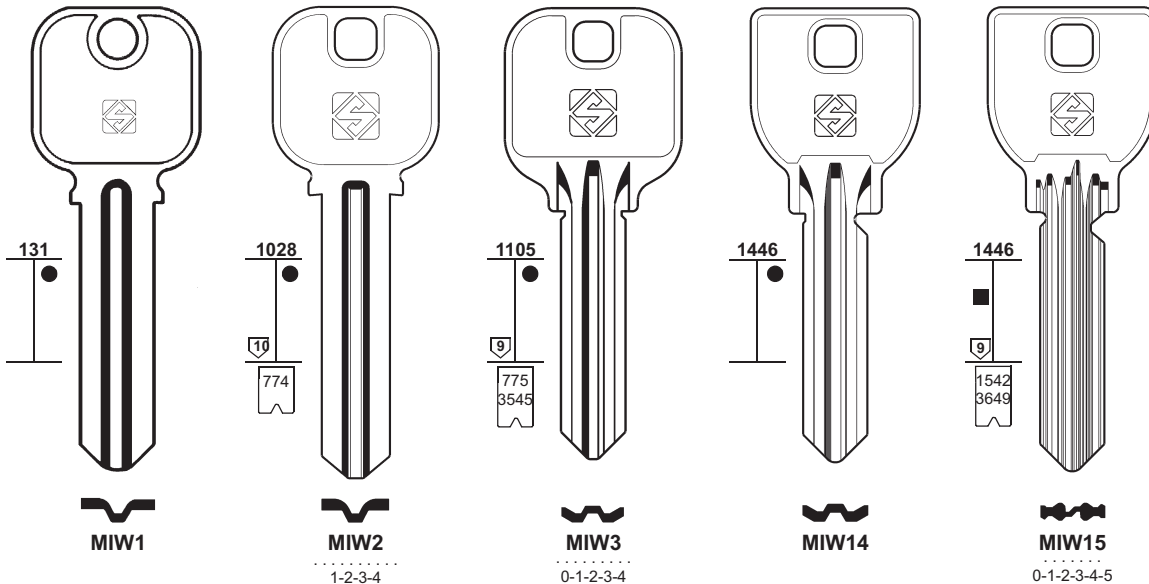

NITI LOCKS



**127**

PER / FOR

**MIWA (J)**  
NITI LOCKS

**MLM (D)**  
DOM  
LEHEMANN  
ORDO  
STUV  
+ DOM (61-62)  
+ OJMAR (134)  
+ RONIS (147)

**MLP (I)**  
GIUSSANI  
+ GIUSSANI (86-87)

PER: **MIWA**  
FOR:

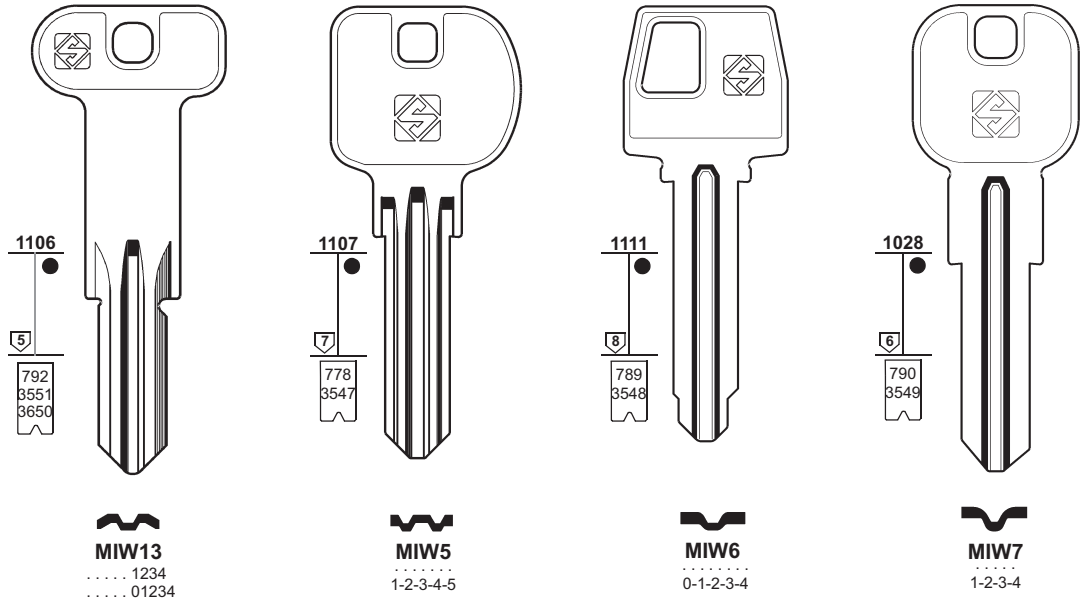

PER: **MLM**  
FOR:

**MLP**

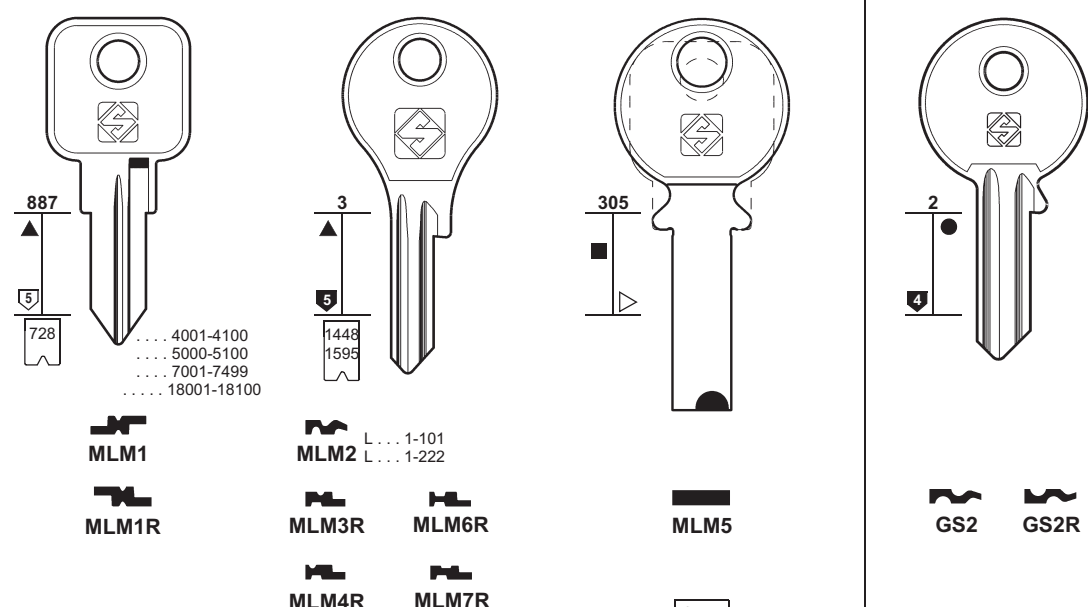

DOM - LEHEMANN - ORDO - STUV

GIUSSANI



# 128

PER / FOR

**MOBELLA (S)**

**MODA (F)**  
PICARDIE (141)

**MODERN (RC)**

**MODERN BAU (D)**  
VACHETTE (181)

**MOFLEX (E)**  
OJMAR (134)

**MON (E)**

**MONACOR (RC)**  
ALPHA (15)

**MONDIAL (F)**  
G.R. (89)  
RONIS (146)

**MONDRAGON (E)**  
MCM (120)

**MONOBLOC (F)**  
FO  
+ ZENITH (201)

**MONTI-MG (I)**

**MOREAUX (F)**  
DOM (63)  
RONIS (146)  
WALLY (188)

**MORI E. (I)**  
CRISTIANI  
LML  
LR  
TAMPALINI  
ZANI  
+ FIAM (79)

PER: FOR:	MOBELLA	MODERN	MON	MONOBLOC

PER: FOR:	MONTI-MG									

PER: FOR:	MONTI-MG		MORI E.		

CRISTIANI - LML - LR - TAMPALINI - ZANI



PER: FOR:	MORI E.	MORI G.
	<p>472 1556 ..... 1-2-3-4-5-6</p>	<p>A 4 5</p>
	<p>MI3 MI7 MI7R</p>	<p>MIG1 MIG2</p>
	FEB	

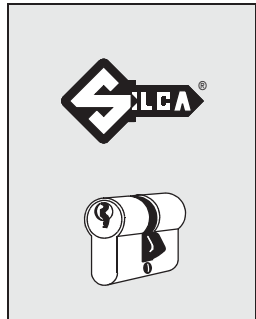

# 129

PER / FOR
MORI E. (I) FEB +  FIAM (79)
MORI G. (I)
MOSCON (RUS)
MOSRENTGEN (RUS)
MOTORSICH (UA)
MOTTA (BR)
MOTTURA (I) GEVY (86)
MP-PLODARI (I)

PER: FOR:	MOSCON	MOSRENTGEN	MOTORSICH
	<p>1081</p>	<p>1101</p>	<p>1147</p>
	<p>MSC1</p>	<p>MST1</p>	<p>MTS1 MTS1R</p>

PER: FOR:	MOTTA	MP-PLODARI
	<p>1532 1532</p>	<p>A 5 A 4 26</p>
	<p>MTT1R MTT2R</p>	<p>▲ MP230 MP231 ▲ MP228 MP229 MP101</p>



# 130

PER / FOR

**MP-PLODARI** (I)

**M.S.S.** (P)

**MST** (I)  
CAS-CISMA (40)

**MSV** (P)

**MUKRA** (D)  
CORBIN (53)

**MULT-LEI** (GR)

**MULT** (BR)

**MUL.T.LOCK** (IL)  
GARRISON  
+ CORNI (55)

PER: **MP-PLODARI**

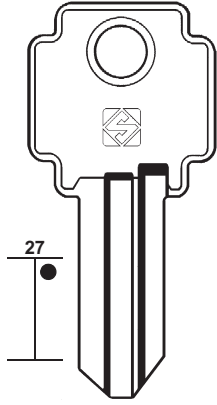

PER: **M.S.S.**

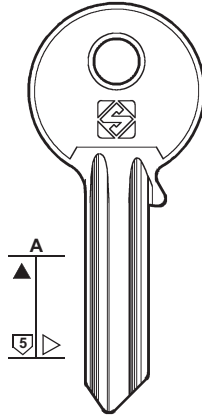

PER: **MSV**

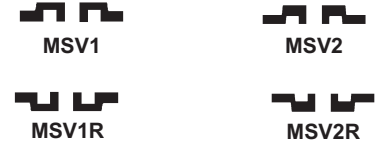
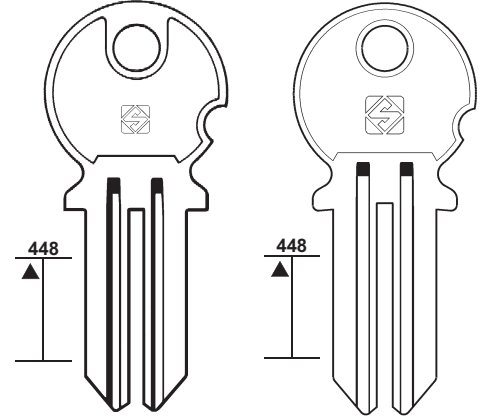

PER: **MULT-LEI**

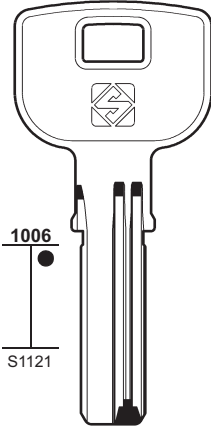

PER: **MULT**

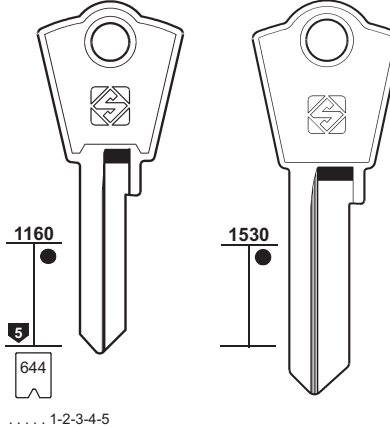

PER: **MUL.T.LOCK**

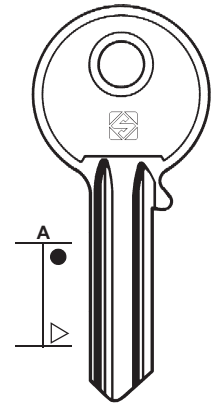

PER: **MUL.T.LOCK**

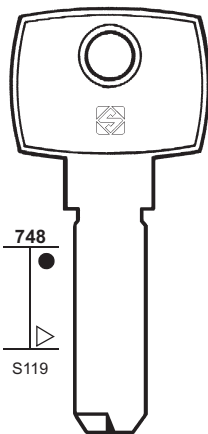

J.....  
9001-9766

**MTK1**

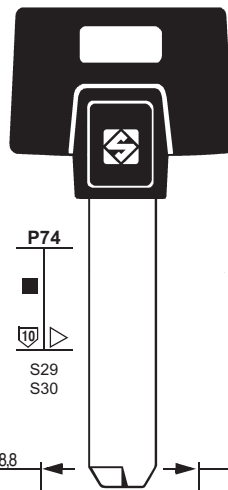

**MTK2P**  
(006)  
ABCD-12345



**MTK3P**  
(006)  
ABCD-12345-01

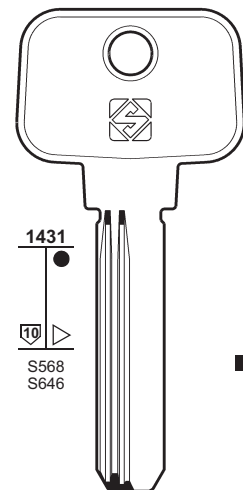

**MTK11R**  
06



**MTK15R**  
66

**MTK16**  
11

**MTK12R**  
08  
(008)  
ABCD-12345

**MTK13R**  
77

**GARRISON**

PER:  
FOR:

# MUL.T.LOCK



# 131

PER / FOR

**MUL.T.LOCK (IL)**  
GARRISON  
SP

+ CORNI (55)

**NABOB (IL)**

**NAIKI (J)**

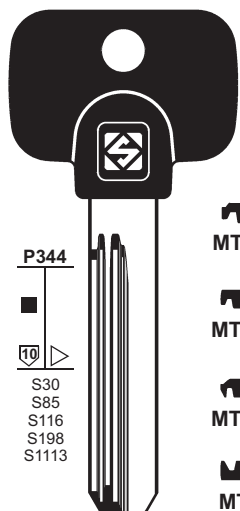

**MTK9RP**

P344



S30  
S85  
S116  
S198  
S1113

(006)  
**MTK8RP** ABCD-12345-01  
64

(006)  
**MTK7RP** ABCD-12345-01  
50

(005)  
**MTK4P** ABCD-12345  
05

(006)  
ABCD-12345-01 **MTK10RP**



SP

(006) **MTK4RP** ABCD-12345-01  
06

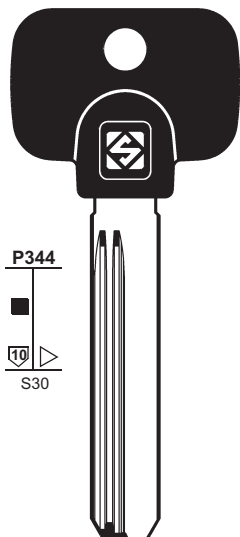

**MTK4RPX**  
06

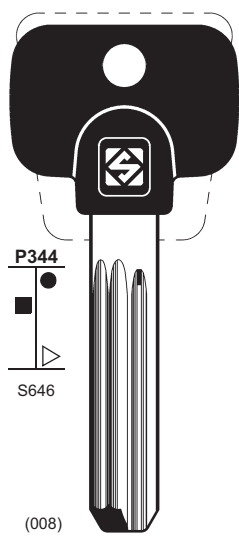

(008)  
ABCD-12345

**MTK12RP**  
08



PER:  
FOR:

# MUL.T.LOCK

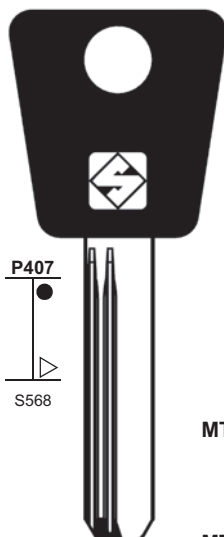

**MTK15RAP**  
66

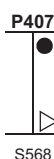

S568

**MTK13RAP**  
77



GARRISON

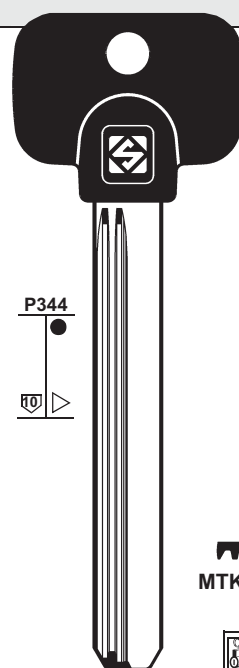

**MTK14RP**



P344



PER:  
FOR:

# NABOB

# NAIKI

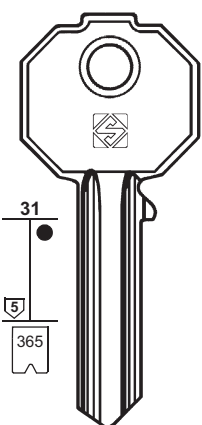

**NAB1**  
.....

0-1-2-3-4-5-6-7-8

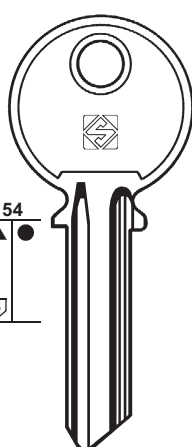

**NAB2**

**NAB6**  
6HB

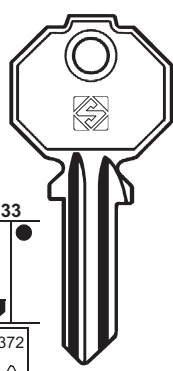

**NAB3R**

0-1-2-3-4-5-6

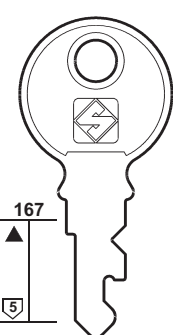

**NR1R**

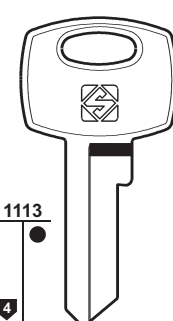

**NK1**  
H...  
1-960

**NK3**  
J...  
1-960

**NK2**  
E...  
1-960



# 132

### PER / FOR

**NATIONAL CABINET (USA)**  
NATIONAL CASH REGISTER  
NATIONAL ROCKFORD

**NATIONAL CASH REGISTER (USA)**  
NATIONAL CABINET (132)

**NATIONAL LOCK HARDWARE (USA)**  
NATIONAL LOCK HARDWARE  
+ NATIONAL CABINET (132)

**NATIONAL ROCKFORD (USA)**  
NATIONAL LOCK HARDWARE  
+ NATIONAL CABINET (132)

**NAZABAL (E)**  
EZCURRA (73)

**NB (D)**  
CISA (48)  
FLORA (81)

**NEC (J)**

**NELFA (DK)**

**NEMEF (NL)**  
+ CES (41-42-43)  
+ CORBIN (53)  
+ RONIS (147)

**NEPTUNE (GB)**

**NICO (D)**  
FTH (81)  
KFV (105)

**NINO (E)**  
TESA (165)

**NITI LOCKS (J)**  
MIWA (127)

**NOBO (N)**  
DOM (60-61-63)  
VING (186)

**NONES (I)**

**NONFANGO (I)**

PER:  
FOR:

## NATIONAL CABINET

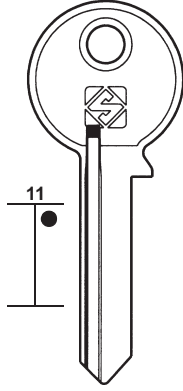

NCR1 NCR1R



NATIONAL CASH REGISTER

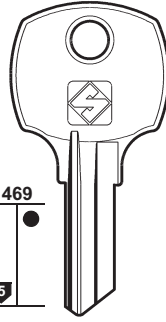

NCR6

NCR11R NCR19

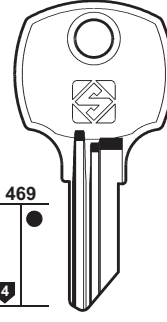

NCR12 NCR13

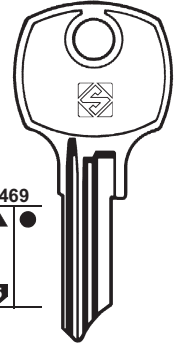

NCR3



NATIONAL ROCKFORD

PER:  
FOR:

## NATIONAL ROCKFORD

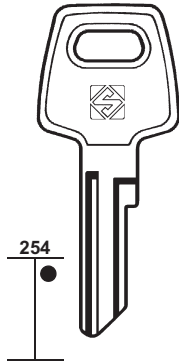

NCR2

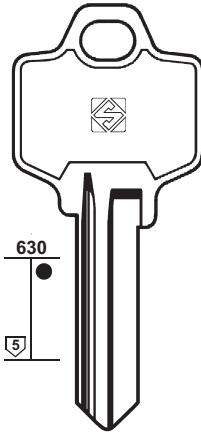

NCR4

NATIONAL LOCK HARDWARE

## NEC

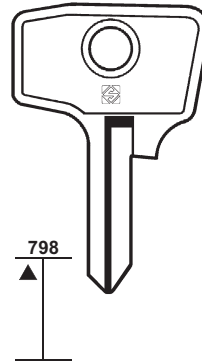

NEC1



## NELFA

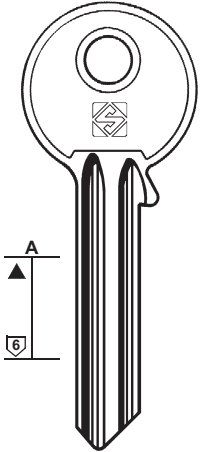

NF1 NF1R

PER:  
FOR:

## NEMEF

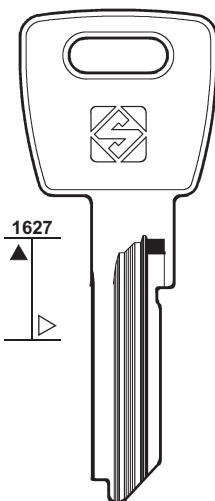

NME1R NME2R  
NF1

## NEPTUNE

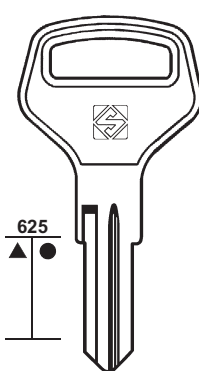

NP1R



## NONES

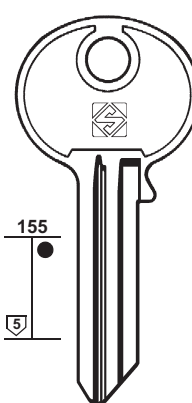

NN1



## NONFANGO

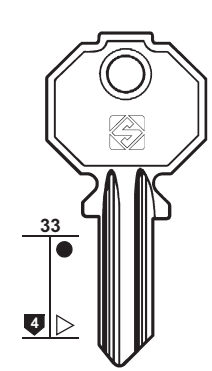

PF12



PER: **NONFANGO**  
FOR:

**OAL**

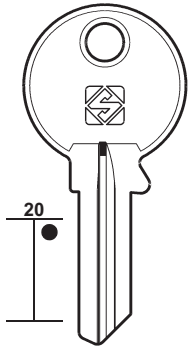

**PT1 PT1R**

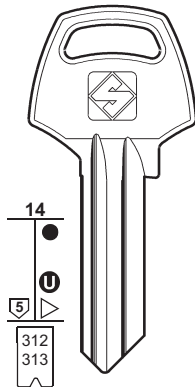

**CB1 CB1R**  
..... 2-3-4-5-6-7-8-9  
..... 1-2-3-4-5-6-7-8-9

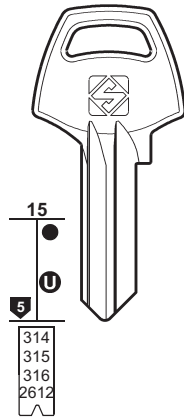

**CB3**  
..... 1-2-3-4-5-6-7-8-9  
..... 2-3-4-5-6-7  
..... 1-2-3-4-5-6-7-8

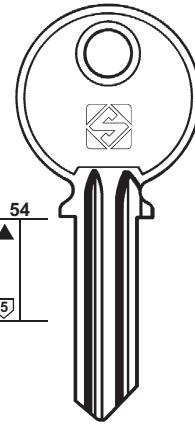

**OAL4**



**133**

PER / FOR  
**NONFANGO (I)**

**NORDWEST (D)**  
👁️ FLORA (81)  
👁️ SCHLECHTENDAHL (152)

**NOVA (D)**  
👁️ TOP (171)  
👁️ YETI (199)

**NOVOFERM (I)**  
👁️ CORBIN (53)

**NOVOTECNICA (I)**  
👁️ MERONI (123)

**NUMIDIA (E)**  
👁️ ESA (69)  
👁️ RONIS (146)

**OAL (I)**  
CORBIN  
+ 👁️ CORBIN (52)  
+ 👁️ GIUSSANI (86)

**OB (I)**  
👁️ ZANETTI A. (200)

**OBEL-ODARIA (J)**

**ODA (NL)**  
👁️ ANKERSLOT (16)  
👁️ CHICAGO (45)

**OFFERMANS-FLOOD (RCH)**

**OJMAR (E)**  
+ 👁️ CES (41-42)  
+ 👁️ HR (93)

PER: **OAL**  
FOR:

**OBEL-ODARIA**

**OFFERMANS-FLOOD**

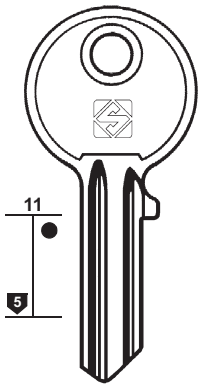

**OAL3**

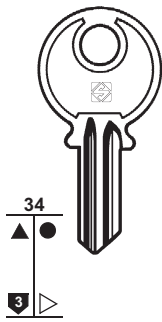

**OAL1 OAL1R**

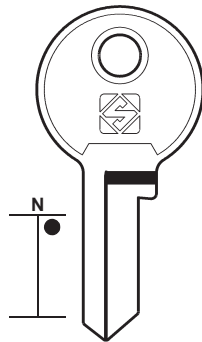

**OB1**

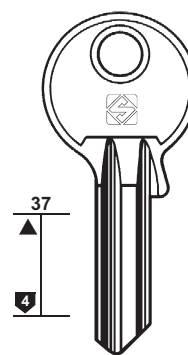

**OF4**



PER: **OJMAR**  
FOR:

**OJMAR**

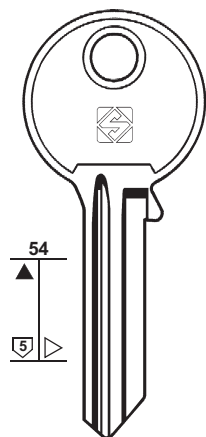

**OJ2**

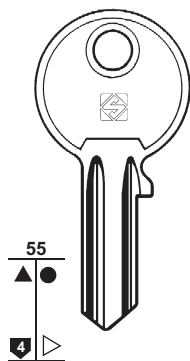

**OJ1 OJ1R**

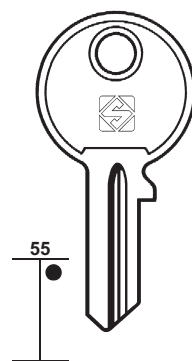

**OJ3R**

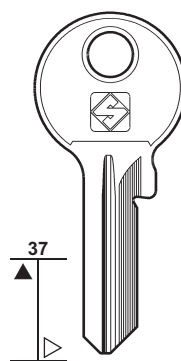

**OJ4 OJ4R**

**OJ16R**

J

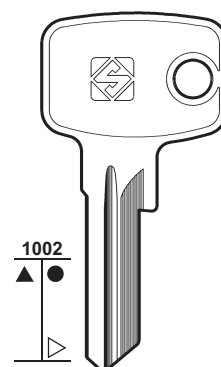

**OJ5R**



# 134

**PER / FOR**

**OJMAR (E)**

BURG  
METAL  
MLM  
MOFLEX  
SISO  
STUMPF  
+ CES (42)  
+ HR (93)

**OLIVA (I)**

FERMABLOCK  
PB  
PREFER

**OLIVETTI (I)**

CASIO  
 GIOBERT (86)

PER:  
FOR:

## OJMAR

A1 ... 1-698  
S ... 1-698  
..... 680  
S ..... 680

A ... 1-698  
S ... 1-698  
U ... 1-698  
..... 680

**OJ8R** F ..... 680      **OJ9** F1

**OJ10R** U ..... 680      **OJ11**

**BURG - METAL - MOFLEX**      **BURG - MLM**  
**SISO - STUMPF**

**OJ15RP** ..... 0-1-2      **OJ18** 5-Q4

PER:  
FOR:

## OLIVA

## OLIVETTI

**OL5R**

**OL5**

**OL4**

**OL6**

**OLT1**

**OLT2**

**FERMABLOCK - PB - PREFER**

PER:  
FOR:

## OLIVETTI

**OLT4**

**OLT5**

**OLT6R** X

**OLT8R** P

**CASIO**      **CASIO**      **CASIO**      **CASIO**

PER:  
FOR:

## OLIVETTI

616      616

**OLT7**  
X

**OLT3**

PER:  
FOR:

## OMA

54      A      A

6      5      4

▲ OA1    OA1R      ▲ OA2    OA2R ●      ▲ OA3R ●

C.A.R.S.      C.A.R.S.

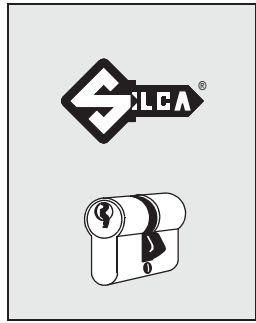

# 135

PER / FOR

**OLIVETTI (I)**  
GIOBERT (86)

**O.M.A. (I)**  
C.A.R.S.

**OMEC (I)**  
SANTOS

PER:  
FOR:

## OMEC

1369      29      29      29      29

5      5      4      3      4

3688      3688      333      334

**OC5**  
.....  
123456789

**OC238**    **OC239 ●**

**OC236**    **OC237 ●**

**OC2**

**OC1**  
..... 1-2-3-4-5

PER:  
FOR:

## OMEC

29      1339      1339      1339

5      6      6      6

333      S661      S711      S710  
334      S1053

⊕ **OC074**    **OC075 ●**

..... 1-2-3-4-5

**OC3**

**OC4**  
AB .....  
000001-0046656

**OC6**  
BA .....  
000001-0046656



# 136

### PER / FOR

#### OMIV (I)

CIB  
STV  
+ BIELLE (30)

#### O.M.R. (I)

MICHEL-SEAT  
+ POTENT (142)  
+ PREFER (143)

#### ONIUN (RC)

UNION (176)

#### ORBA (D)

SIMECA (155)

#### ORDO (F)

+ KIFERM (106)  
+ LAS (111)  
+ MLM (127)

#### ORION NOVOX (F)

DECAYEUX

#### ORLANDO (I)

ICSA (94)

#### ORO (IL)

#### ORSA (BY)

#### OSKO (D)

JOWIL (100)

#### OT (I)

FONDAR (81)

#### OTHMER (D)

ABUS (6)

#### OTIS (I)

CES (42)  
 ILLINOIS (96)  
 ZEISS-IKON (200)

#### OTTO (I)

BURG (37)

PER:  
FOR:

## OMIV

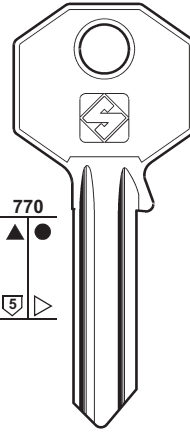
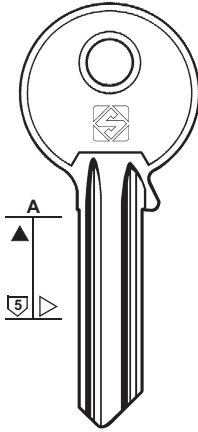
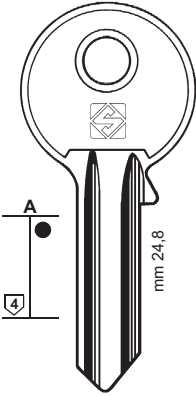

OV1



OV1R



OV2



OV2R



OV3



OV3R

CIB - STV

CIB - STV

## O.M.R.

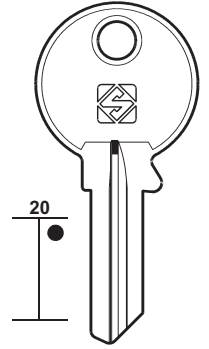
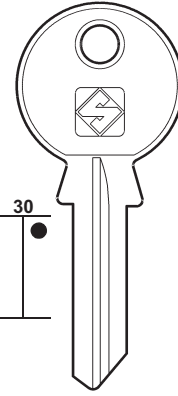

MH2



MH2R



PT1



PT1R

MICHEL-SEAT

PER:  
FOR:

## O.M.R.

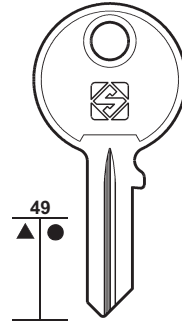
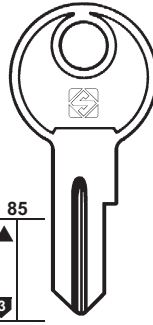
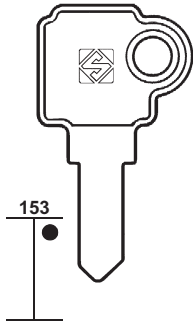

SEA5



SEA5R



MET1

B... 1-600  
G... 1-600



OMR1R



SEA7



SEA8



MICHEL-SEAT



MICHEL-SEAT

## ORDO

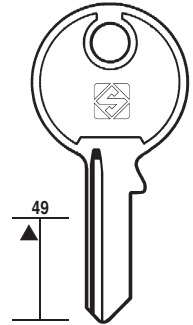

OR1R



PER:  
FOR:

## ORION NOVOX

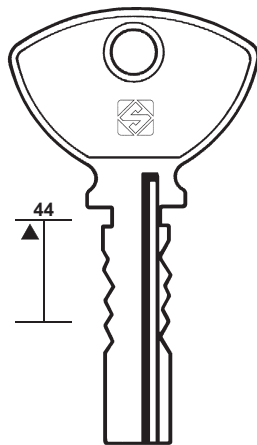

ON1



ON1R

DECAYEUX

## ORO

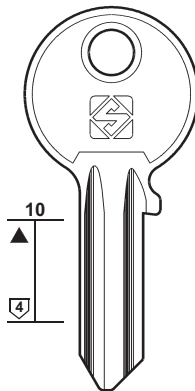

ORO1



ORO2

## ORSA

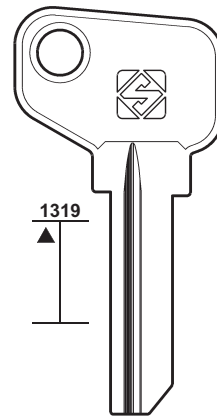

ORA1

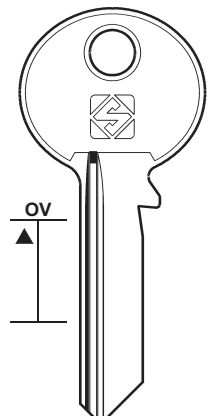

ORA2



PER:  
FOR:

### PACRI

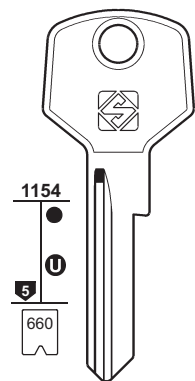

..... 1-2-3-4-5-6-7



PAC1R

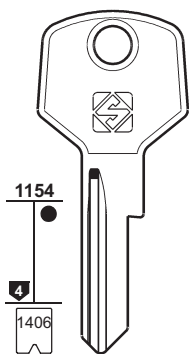

..... 1-2-3-4



PAC2R

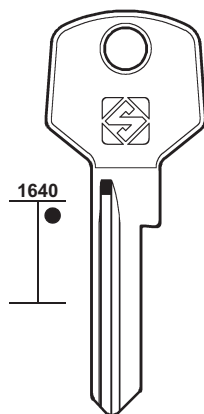

PAC3R

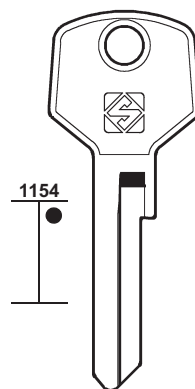

PAC4



# 137

PER / FOR

PACRI (BR)

PADO (BR)

PER:  
FOR:

### PADO

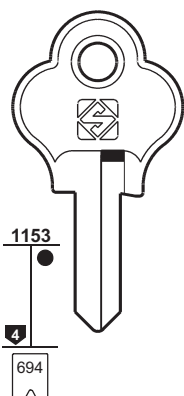

..... 1-2-3



PDO12



PDO12R

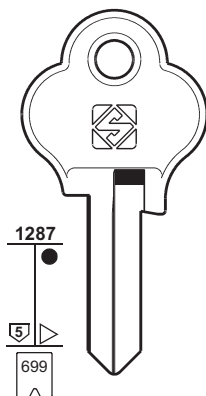

..... 1-2-3-4-5



PDO17



PDO17R

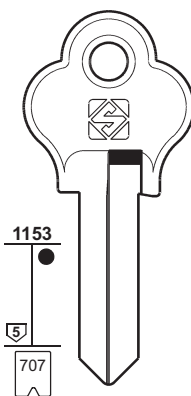

..... 1-2-3-4-5-6



PDO2

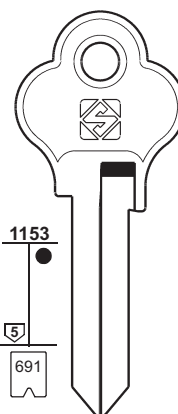

..... 1-2-3-4-5



PDO9



PDO9R

PER:  
FOR:

### PADO

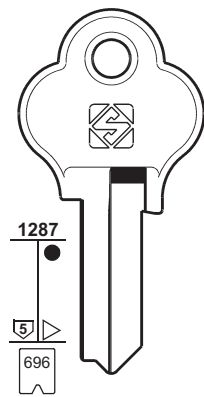

..... 1-2-3-4-5



PDO14



PDO14R

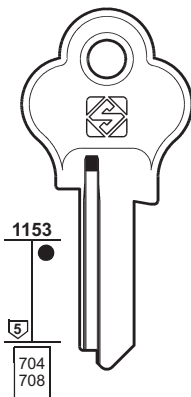

..... 1-2-3-4-5



PDO1R



PDO1R

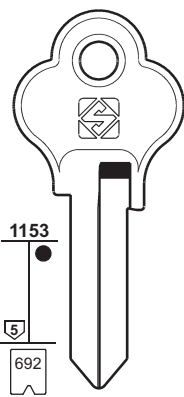

..... 1-2-3-4-5



PDO10R



PDO10R

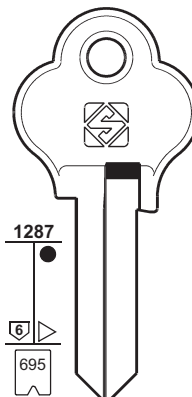

..... 1-2-3-4-5-6



PDO13



PDO13R

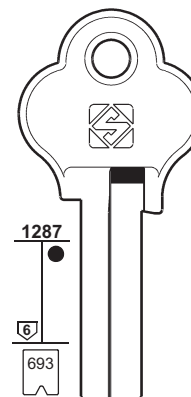

..... 1-2-3-4-5



PDO11



PDO11



# 138

PER / FOR

**PADO** (BR)

**PANDA** (F) (RC)

**PANTHER** (D)  
JOWIL (100)

**PAPAIZ** (BR)

PER:  
FOR:

## PADO

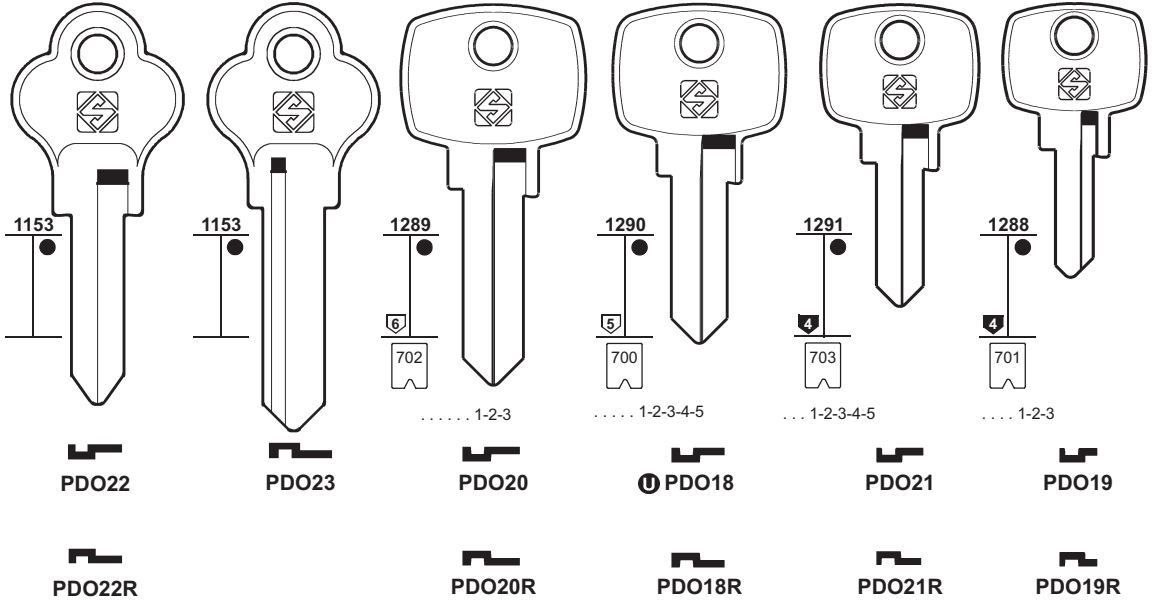

PER:  
FOR:

## PANDA

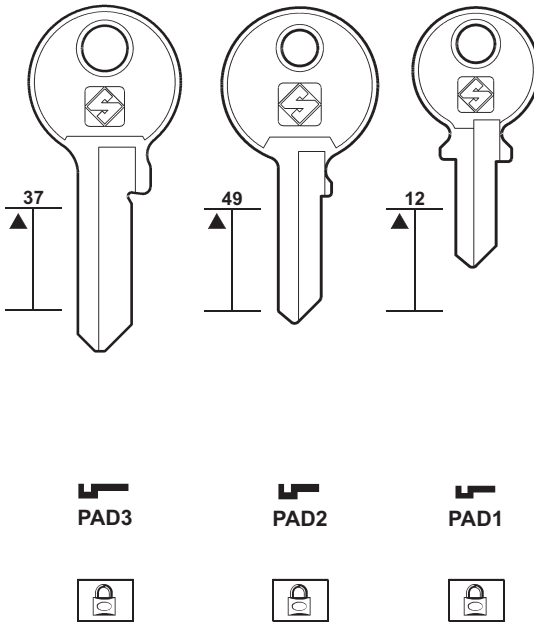

## PAPAIZ

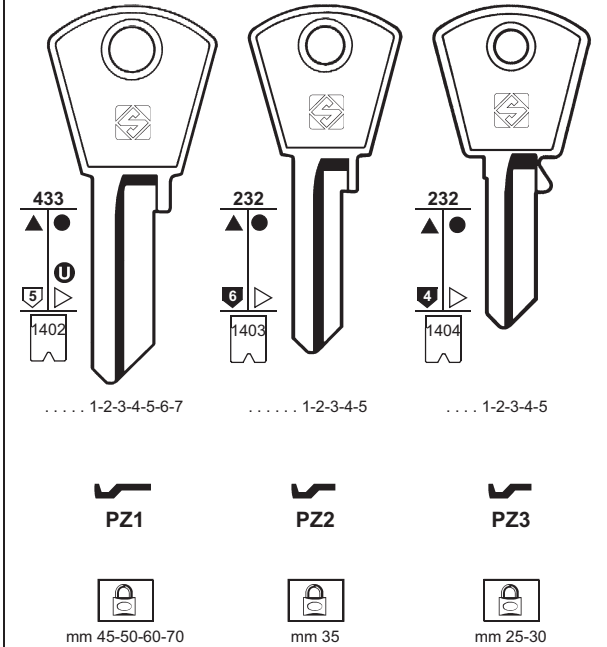

PER:  
FOR:

## PAPAIZ

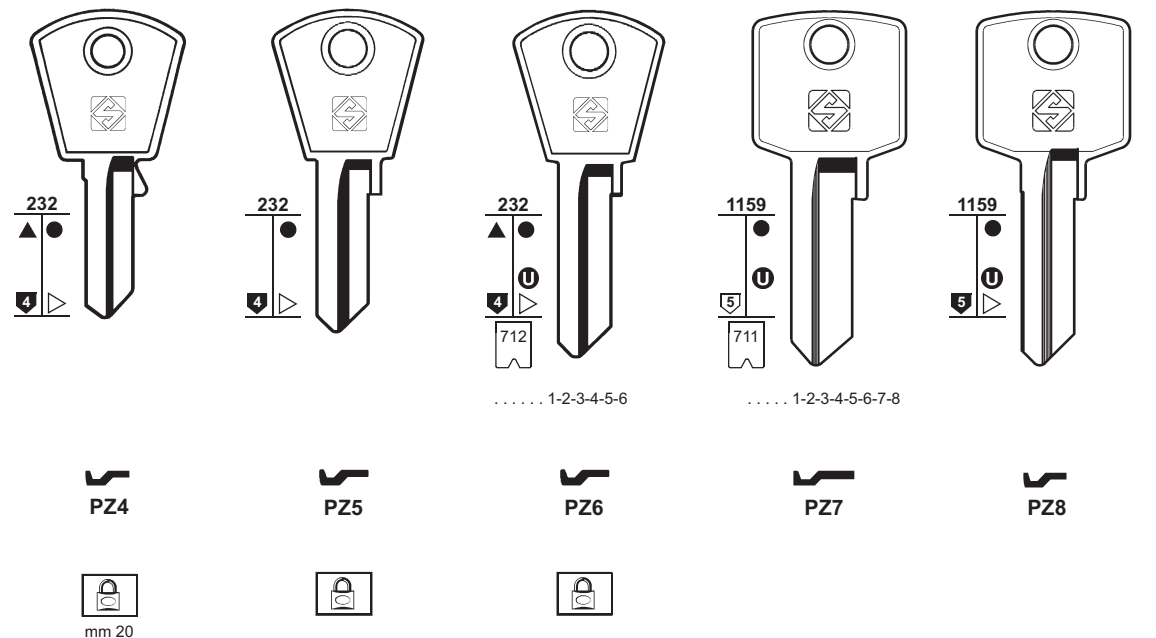

PER:  
FOR:

## PAPAIZ

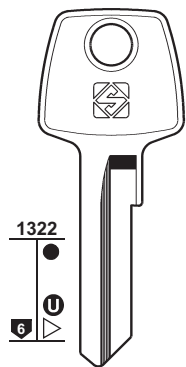

PZ9

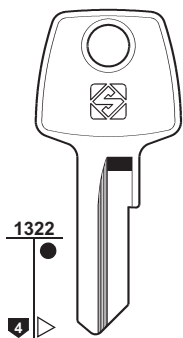

PZ14

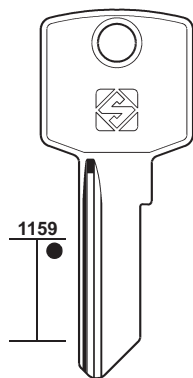

PZ18R

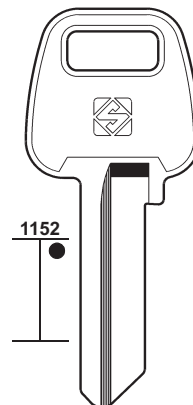

PZ17



# 139

PER / FOR

**PAPAIZ** (BR)

**PARMA** (I)

**PAS** (I)

👁️ PREFER (143)

**PASSY** (F)

👁️ RICOUARD (146)

**PASTORE** (I)

👁️ GIUSSANI (87)

👁️ PREFER (142)

**P.B.** (I)

👁️ OLIVA (134)

**P.C. (CORTELLEZZI)** (I)

ETNA

FEB

FPB

FRAL

LUNA

PLODARI

SANTOS

SAVIO

+ 👁️ BIELLE (30)

+ 👁️ JVAL (102)

PER:  
FOR:

## PAPAIZ

## PARMA

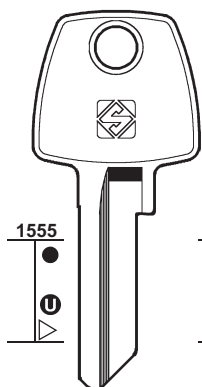

PZ15

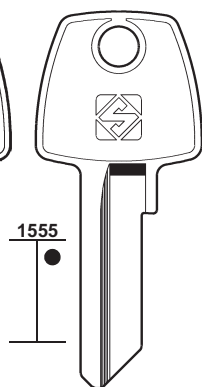

PZ19

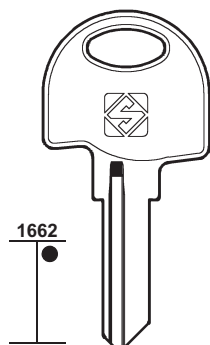

PZ20R

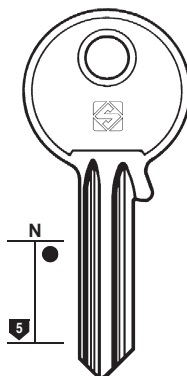

PA2



▲PA2R

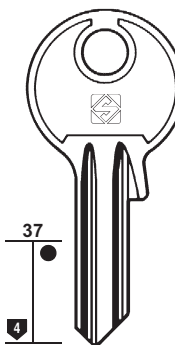

PA1



PA1R

PER:  
FOR:

## P.C. (CORTELLEZZI)

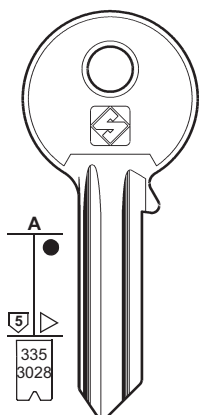

PC14

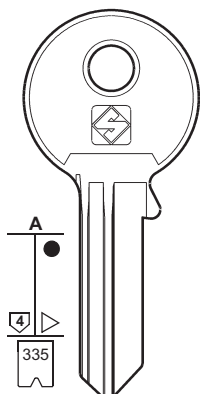

PC20



PC18R ▲●

... 1-2-3-4-5

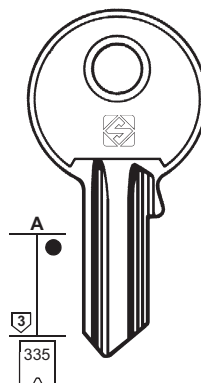

PC4

PC4R

... 1-2-3-4-5

PC10

PC10R ▲●

... 1-2-3-4-5

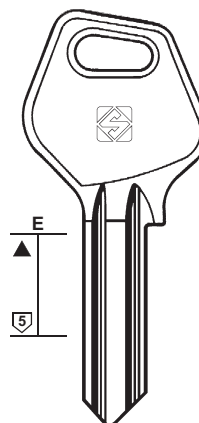

PC13

▲●PC1

PC1R

... 1-2-3-4-5

... 1-2-3-4-5-6-7

ETNA - FEB - FPB  
FRAL - SANTOS - SAVIO

ETNA - FEB  
FPB - LUNA - PLODARI



# 140

PER / FOR

**P.C. (CORTELLEZZI) (I)**

CASMA  
FEB  
GEVY  
JVAL  
R.S.M.  
SILCA  
SUL

+ BIELLE (30)  
+ JVAL (102)

**PENZA (RUS)**

**PERINO PG (I)**  
IMSI

**PEROHAUS (F)**

DOM (61)  
 GEGE (84-85)  
 JUNIE (101)

**PERRIER (F)**

G.R. (90)

**PETERBORO (USA)**

DOMINION (66)

PER:  
FOR:

## P.C. (CORTELLEZZI)

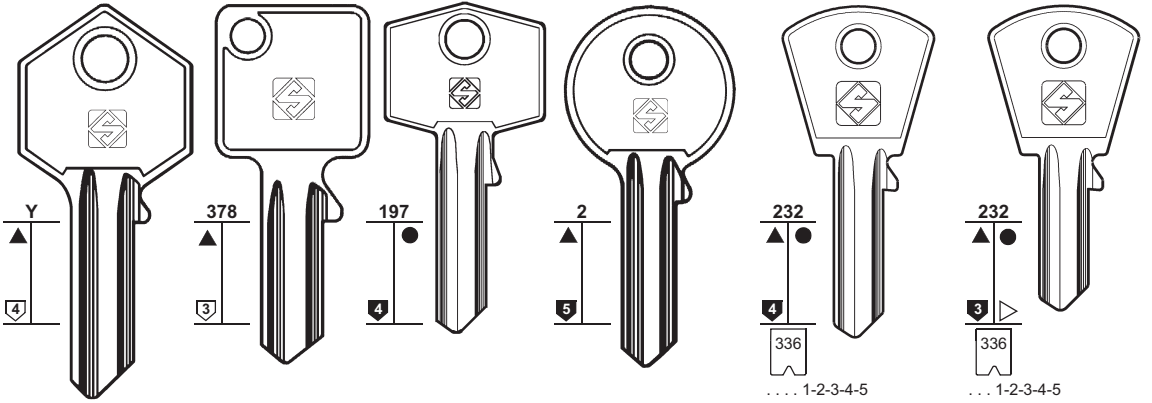

PC11

PC5

PC6

PC8

PC2

PC3

● PC2R

GEVY - R.S.M.

JVAL - SUL

CASMA



PER:  
FOR:

## P.C. (CORTELLEZZI)

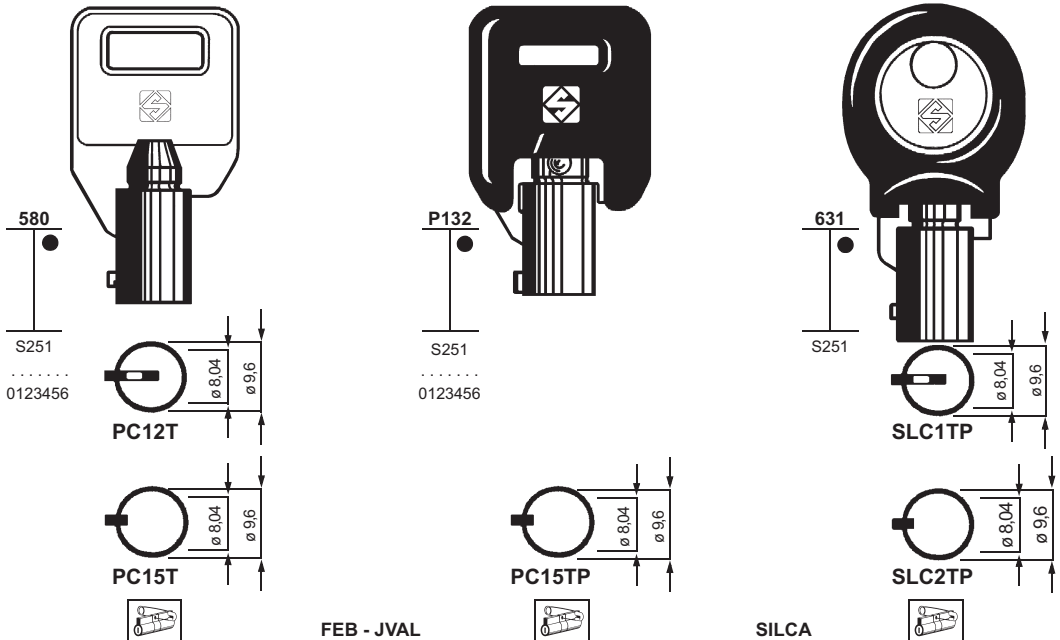

PC12T

P132

631

S251  
.....  
0123456

S251  
.....  
0123456

S251

PC15T

PC15TP

SLC2TP

FEB - JVAL

SILCA

PER:  
FOR:

## PENZA

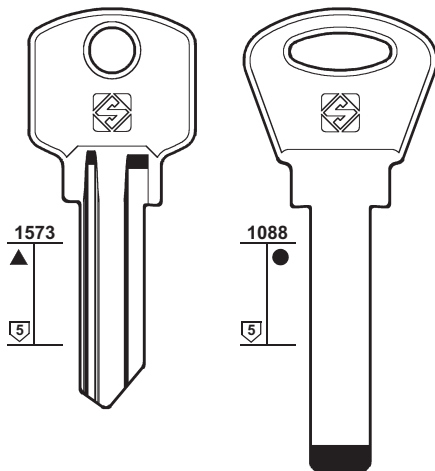

BZ2

BZ2R

BZ3



IMSI

## PERINO PG

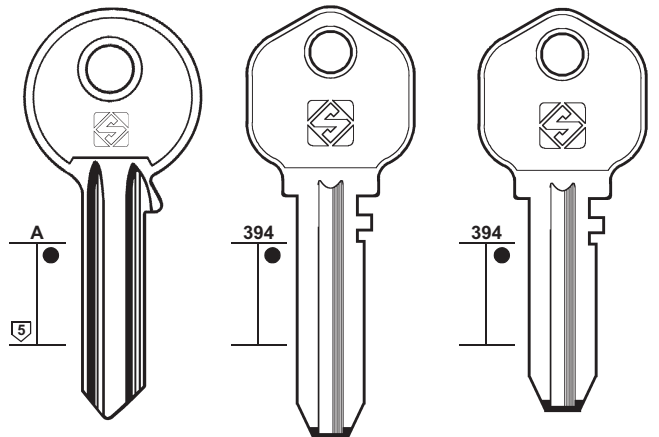

▲ PG1

PG1R

PN1

PN2



IMSI



PER: **PETROZAVODSK**  
FOR:

**PFAFFENHAIN**



**141**

PER / FOR

**PETROZAVODSK**  
(RUS)

**PFAFFENHAIN (D)**  
ABUS  
BUVA

**PICARD (F)**  
BETA (29)  
KABA (102)

**PICARDIE (F)**  
DECAYEUX  
MODA  
S & E  
STS  
+ AMARO LIMITADA (15)  
+ FTH (81)  
+ GABON (84)  
+ SIS (156)  
+ TITAN (167)

**P.J. (F)**  
RONIS (147)

**P.K. (F)**  
LAS (110)

**PLG (I)**  
GIUSSANI (86)

**PLODARI (I)**  
P.C. (139)

**PM (F)**  
RONIS (146-147)

**POLI (RCH)**

**POPLOCK (I)**  
CORBIN (52-53)

**POS (D)**  
SIGENIA

**POTENT (I)**  
MICHEL (126)

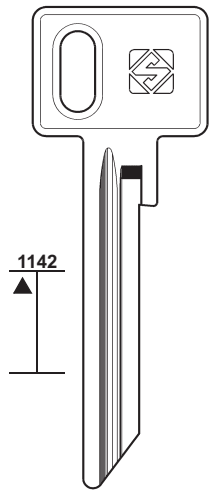

1142

**PTZ1R**

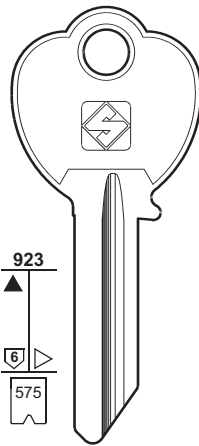

923

6  
575

**PHF1R**  
HK

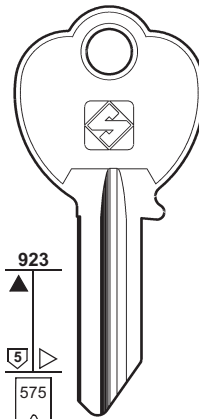

923

5  
575

**PHF2R**  
L

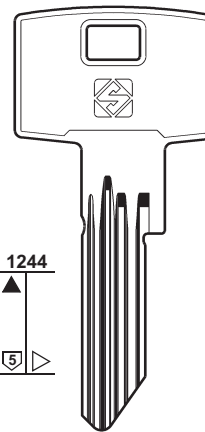

1244

5

**PHF7R**

**PHF8R**

**PHF9R**

**PHF10R**

**PHF11R**

**PHF12**

**PHF15**

**PHF5**

**PHF6**

**PHF4R**



ABUS

ABUS

PER: **PFAFFENHAIN**  
FOR:

**PICARDIE**

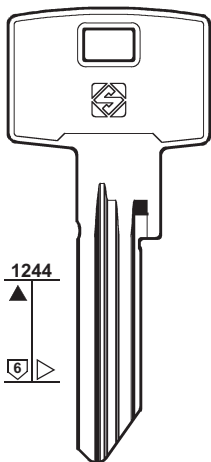

1244

6

**PHF16R**  
SRA  
BUVA

**PHF23**

**PHF22R**

**PHF19**  
EA

**PHF18R**  
FD

**PHF17**  
ED

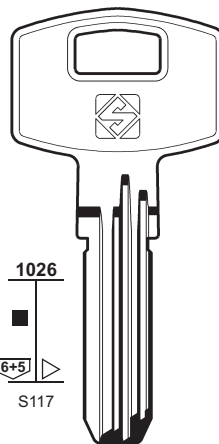

1026

6+5  
S117

**PIC1**

DECAYEUX - MODA  
S & E - STS

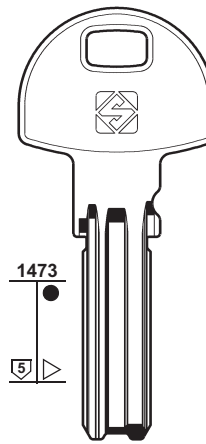

1473

5

**PIC2**



PER: **POLI**  
FOR:

**POS**

**POTENT**

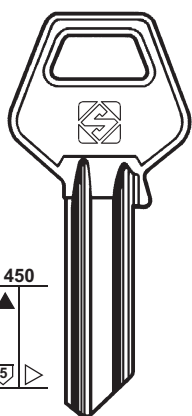

450

5

**PL1**

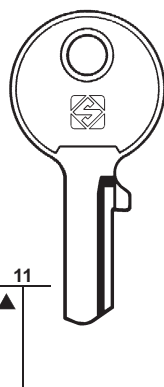

11

**PS1**  
CZ

SIGENIA

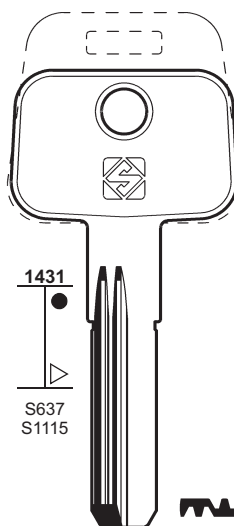

1431

S637  
S1115

**PT4R**

..... 1-2-3-4-5

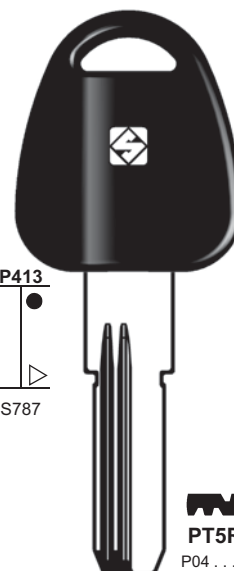

P413

S787

**PT5RP**

P04 .....  
1-2-3-4-5-6





# 142

### PER / FOR

#### POTENT (I)

AM  
MICHEL  
NONFANGO  
O.M.R.

+ MICHEL (126)

#### PREFER (I)

BLOCUS  
CAP  
CIB  
FATTORINI  
JIP  
PASTORE  
PROMO  
UNIFOR

+ OLIVA (134)

+ TRAU (172)

PER:  
FOR:

## POTENT

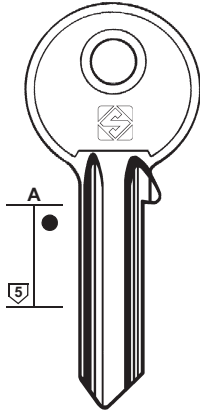

PT2

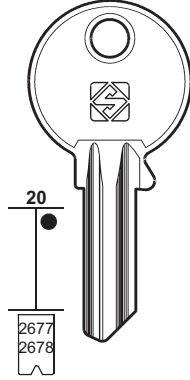

MH1  
... 201-436



MH1R  
... 437-672

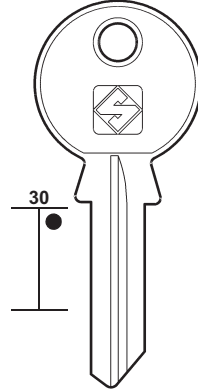

MH2



MH2R

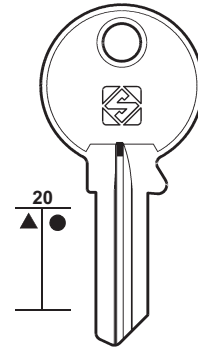

PT1



PT1R



AM  
MICHEL  
NONFANGO

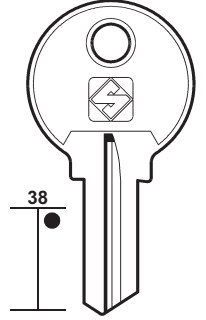

MH4



MH4R



MICHEL  
O.M.R.

PER:  
FOR:

## PREFER

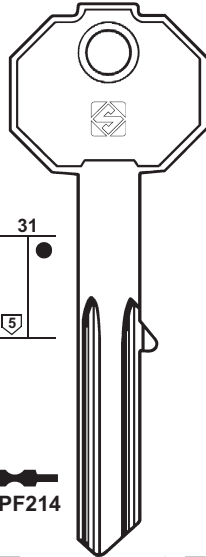

PF214



PF215

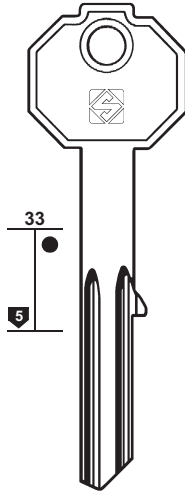

PF215R

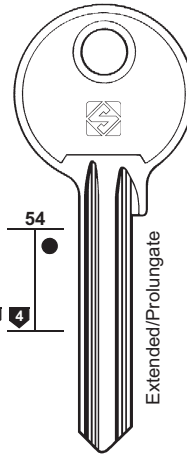

PF3



PF3R



PF11



PF11R

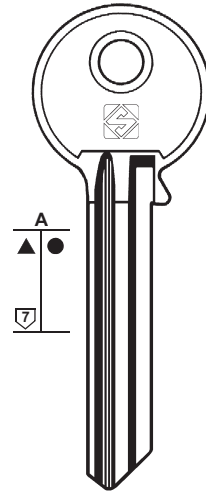

PF7



PF7S

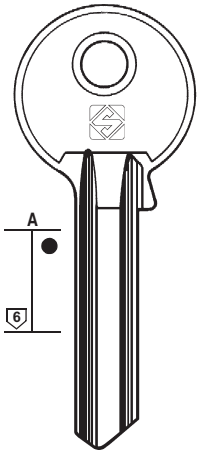

PF8



PF8R

PER:  
FOR:

## PREFER

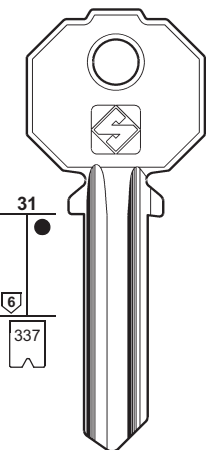

PF6



PF6R

..... 1-2-3-4-5

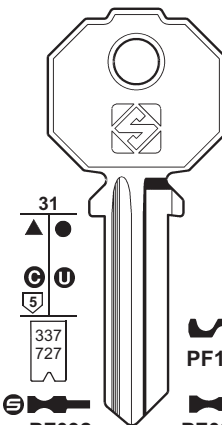

PF92

..... 1-2-3-4-5



PF16R



PF92S

..... 1-2-3-4-5

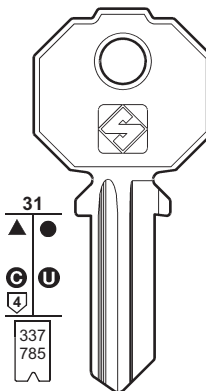

PF2

..... 1-2-3-4-5



PF2S

..... 1-2-3-4-5

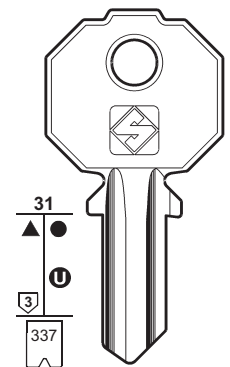

PF5

..... 1-2-3-4-5



PF5S

..... 1-2-3-4-5



BLOCUS - CAP - CIB - JIP  
PASTORE - PROMO



BLOCUS - CAP - CIB  
FATTORINI - PASTORE - PROMO



UNIFOR

PER:  
FOR:

# PREFER

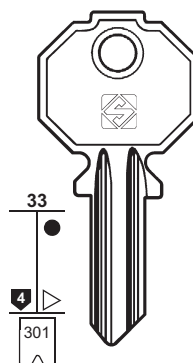
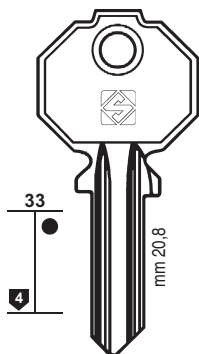
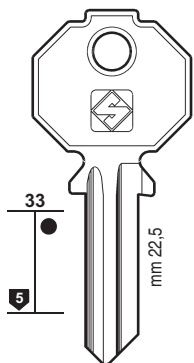
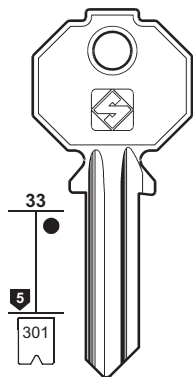

▲ PF072 PF073  
..... 1-2-3-4-5

PF15 PF19

PF9 PF9R

PF12  
... 501-700



NONFANGO



# 143

PER / FOR

**PREFER (I)**  
FOSAM  
IMBAC  
LIPS VAGO  
METALCASTELLI  
NONFANGO  
O.M.R.  
PAS  
SERITAL  
SWEDA  
+ OLIVA (134)  
+ TRAU (172)

**PRESTA (D)**  
 BOMORO (33)  
 LA PORTE (110)

PER:  
FOR:

# PREFER

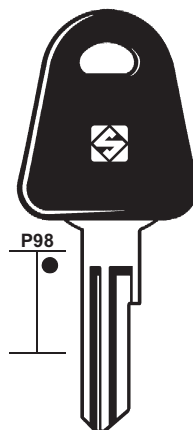
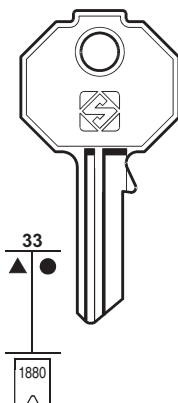
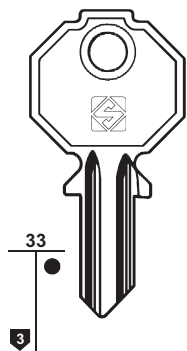
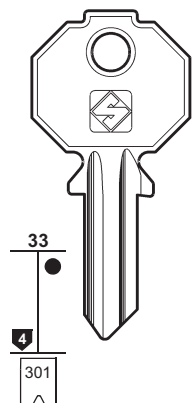

▲ PF070 PF071  
..... 501-700

PF4 PF4R

PF1R PF1  
..... 1234

PF1RP ▲ PF1P



LIPS VAGO - PAS - SWEDA

FOSAM

METALCASTELLI  
SERITAL - O.M.R.

METALCASTELLI

PER:  
FOR:

# PREFER

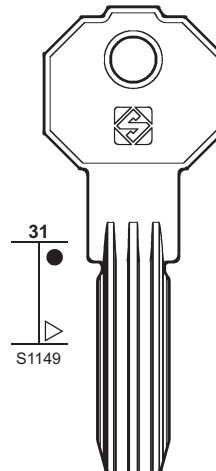
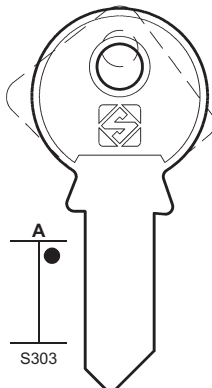
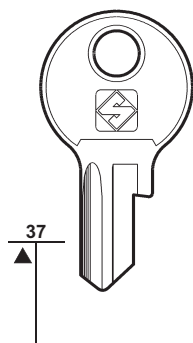
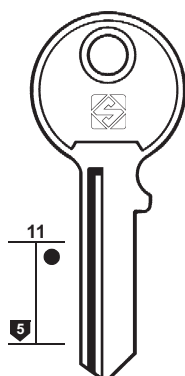

PF13R

PF14

PF18

PF20



IMBAC





# 144

PER / FOR

**PRIM** (CH)

**PRIVE** (RA)  
YALE (193)

**PROBAT** (F)  
FTH (81)

**PROFILMAR** (F)

**PROMECA** (F)  
RONIS (146)

**PROMETA** (I)

**PROMO** (I)  
PREFER (142)

**PROTEC** (F)  
CITY (51)  
KVR (108)

**PUNDRA** (USA)

**QCP** (F)  
CITY (51)  
ZENITH (201)

**RABBIT** (HK)

**RAFI** (D)  
DOM (61)

**RAM** (RC)  
YETI (198-199)

**RAMIS** (ET)

**RAUCO** (D)  
HEKNA (92)

**R.C.** (I)  
CRISTANI (56)

**READING** (USA)  
SEGAL (153)

**RECA** (I)  
INDESIT (96)

**REDY** (IND)  
LOB (114)

**REGAL** (GB)

**REGENT** (USA)  
HEKNA (92)  
HENDERSON (93)

**REGISTRATORI DI CASSA** (I)

**RELIANCE** (J)

**REMO** (I)  
ICSA (94)

PER: FOR:	PRIM	PROFILMAR	PROMETA	PUNDRA
	 PRI3R	 PRL1	 PM1	 PD1

PER: FOR:	RABBIT	RAMIS	REGAL
	 YA1 YA1R	 RBT2	 RG1
	..... 0-1-2-3-4-5-6-7-8-9	FP... 626-750	

PER: FOR:	REGISTRATORI DI CASSA	RELIANCE
	 RDC1 Z	 REL1R REL2
		 REL3



PER:  
FOR:

# RENZ

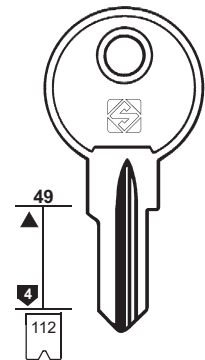

**KI5**  
C ... 1-275  
XS ... 1-275

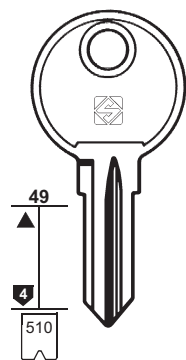

**KI5R**  
SX ... 1-275  
XT ... 1-75  
RX ... 1-275

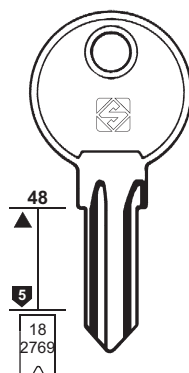

**KI12** ... 151-218  
... 101-150  
... 1116-7776  
H ... 1116-7776  
E ... 425-499

**KI12R** ... 1-68  
... 51-100  
H ... 500-574  
E ... 1116-7776

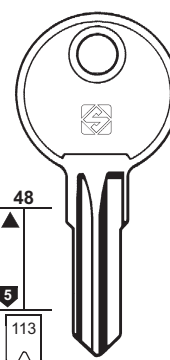

**LS1** R ... 1-224

**LS1R** V ... 1-224

**LS2** AX ... 1-224

**KI7**  
XY ... 1-275

ATAL



# 145

PER / FOR

**RENZ (D)**  
ATAL  
+ KIFERM (106)  
+ LAS (110)

**RESMINI (I)**

**REX (DK)**

PER:  
FOR:

# RENZ

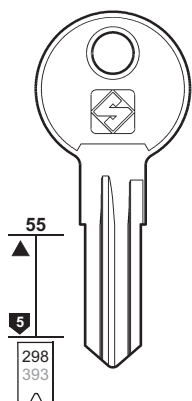

**REN1** REN1R  
... 1-200

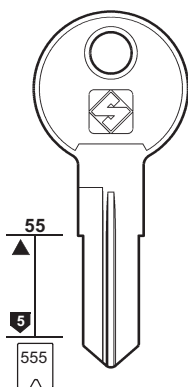

**REN2** REN2R  
32 ... 001-200

**REN4R**

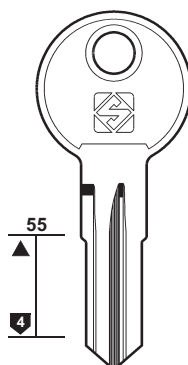

**REN3R**

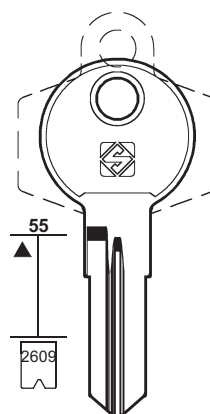

**REN5R**  
ER ... 1-500



PER:  
FOR:

# RESMINI

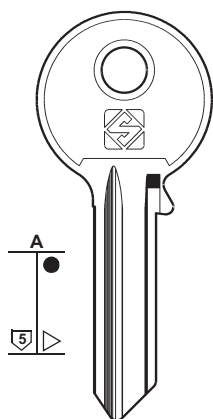

**RM1A** RM1RA

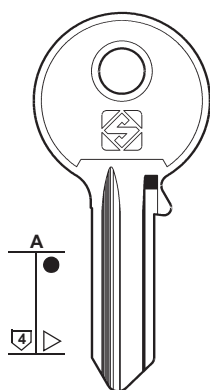

**RM2A** RM2RA

# REX

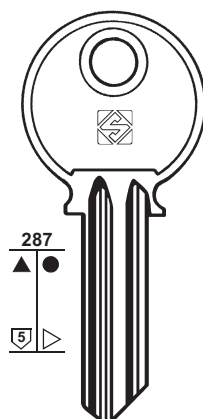

**RX2**

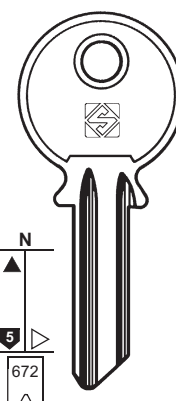

**RX1**  
K ... 1-50



# 146

PER / FOR

**RGM (E)**

**RICOUARD (F)**

COUILLET  
DECAYEUX  
KIFERM  
LAS  
PASSY  
YVEL

**RIGA (LV)**

**RIPA (E)**

IFAM (95)

**RIQUIER (F)**

G.R. (89)

**RIV (E)**

UCEM (175)

**RIVERS (AUS)**

**RJAZAN (RUS)**

**ROC (F)**

YALE (193)

**ROLEX (GR)**

ZANETTI A. (200)

**ROLL-A-DOOR (GB)**

+ LEN-LOK (111)

+ L & F (117)

**ROMA (I)**

**RONEO (E)**

RONIS (147)

**RONIS (F)**

ANTAR

BLOCUS

CATOR

DAD

DC

DEBEAURAIN

DELTA

DERLOCHE

DESPREZ

EMGE

EMHART

EQUIBATIR

FONTAINE

FORINDEX

GOLLOT

GUIDOTTI

JIP

LAPERCHE

LIONA-LIOX

MAFOR

MONDIAL

MOREAUX

NUMIDIA

PM

PROMECA

SESA

SOFRANQ

STREMLER

VEGA

+ EMKA (69)

+ LAS (110-111)

+ VACHETTE (181)

PER:  
FOR:

**RGM**

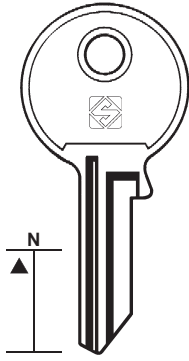

RGM1 RGM1R

**RICOUARD**

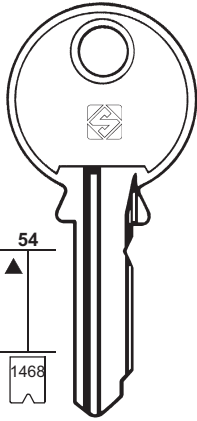

RIC1

K... 726-950

COUILLET - DECAYEUX  
KIFERM - LAS - PASSY - YVEL

**RIGA**

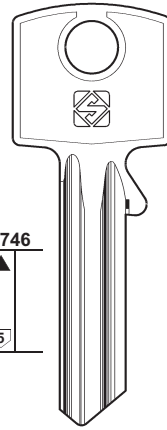

RGA1

**RIVERS**

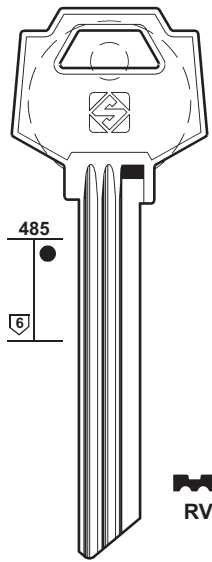

RV1

PER:  
FOR:

**RJAZAN**

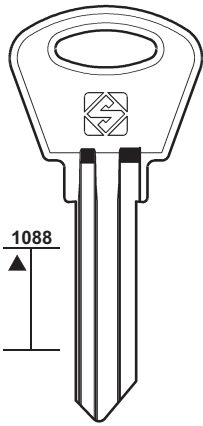

RZA1

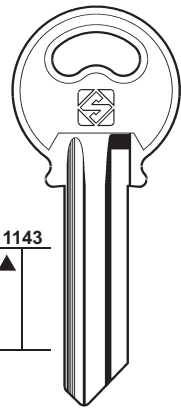

RZA2

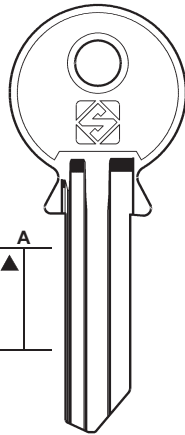

RZA3

**ROLL-A-DOOR**

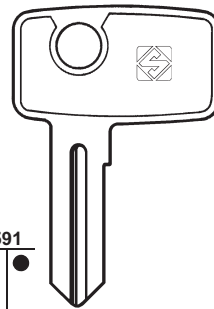

RD1

RD2  
19... 1-420

**ROMA**

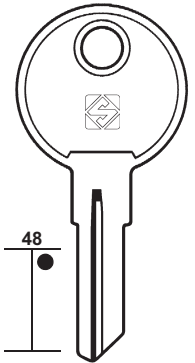

RA1

PER:  
FOR:

**RONIS**

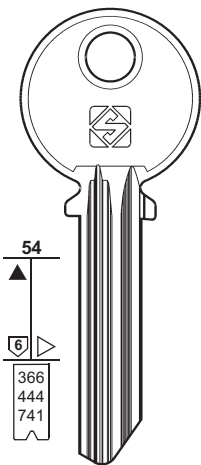

54

366  
444  
741

0-1-2-3-4-5-6-7-8-9

1-2-3-4-5-6-7-8-9

K...  
KK...  
N...  
NN...  
123456789

RO9 RO9R

ANTAR  
LAPERCHE - SESA

UUL RO23 RO23R  
FL  
LAPERCHE

UUK RO25 RO25R  
FK  
LAPERCHE

UUM RO27 RO27R  
FM  
LAPERCHE

RO47 RO47R

1-1296  
V20... 1-1296  
1234567890  
A/Z... 1234567890

RO41  
DAD

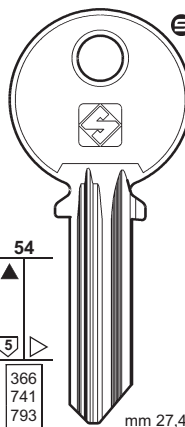

54

366  
741  
793

mm 27,4

MX... 1100-1699  
A/Z... 12345678  
A/Z... 12345678  
ANTAR... 123456789  
BLOCUS... 9... 123456789  
CATOR... J... 123456789

RO8

ANTAR

BLOCUS

CATOR

DC

DEBEAURAIN

DELTA

DERLOCHE

DESPREZ

EMGE

EMHART

EQUIBATIR

FONTAINE

FORINDEX

GOLLOT

GUIDOTTI

JIP

LAPERCHE

LIONA-LIOX

MAFOR

MONDIAL

MOREAUX

NUMIDIA

PM

PROMECA

SESA

SOFRANQ

STREMLER

VEGA

RO8R

9 123456789

N 123456789

9 123456789

TTL RO22 RO22R  
FL  
LAPERCHE

TTK RO24 RO24R  
FK  
FONTAINE  
LAPERCHE

TTM RO26 RO26R  
FM  
LIONA-LIOX  
LAPERCHE

RO37

RO37R  
ET

RO43R

0-1-2-3-4-5-6-7-8-9

PER:  
FOR:

# RONIS

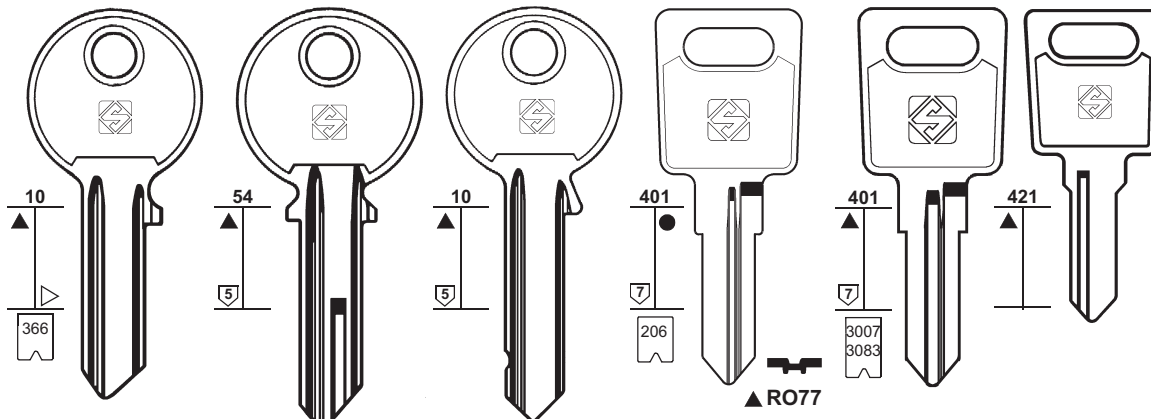

**RO7**   **RO7R**  
... 0-1-2-3-4-5-6-7-8

**RO13**

**RO14**

**RO67**  
NA ...  
4001-5000

**RO67R**  
ND ...  
4001-5000

**RO69**  
CC ... 1-2000

**RO46R**

ANTAR - GIMM  
JIP - LAPERCHE  
PM - SESA

SOLOR

CATOR

**RO68**  
NC ...  
4001-5000

**RO68R**  
NB ...  
4001-5000



# 147

PER / FOR

**RONIS (F)**

- ANTAR
- ARMOR
- BURG
- CATOR
- DAV
- EMHART
- EMKA
- FORINDEX
- GIMM
- JIP
- KARDEX
- LAPERCHE
- MLM
- NEMEF
- P.J.
- PM
- RONEO
- SANEL
- SCHÄFER
- SESA
- SOLOR
- STRAFOR
- TAV
- YAC
- + EMKA (69)
- + LAS (110-111)
- + VACHETTE (181)

PER:  
FOR:

# RONIS

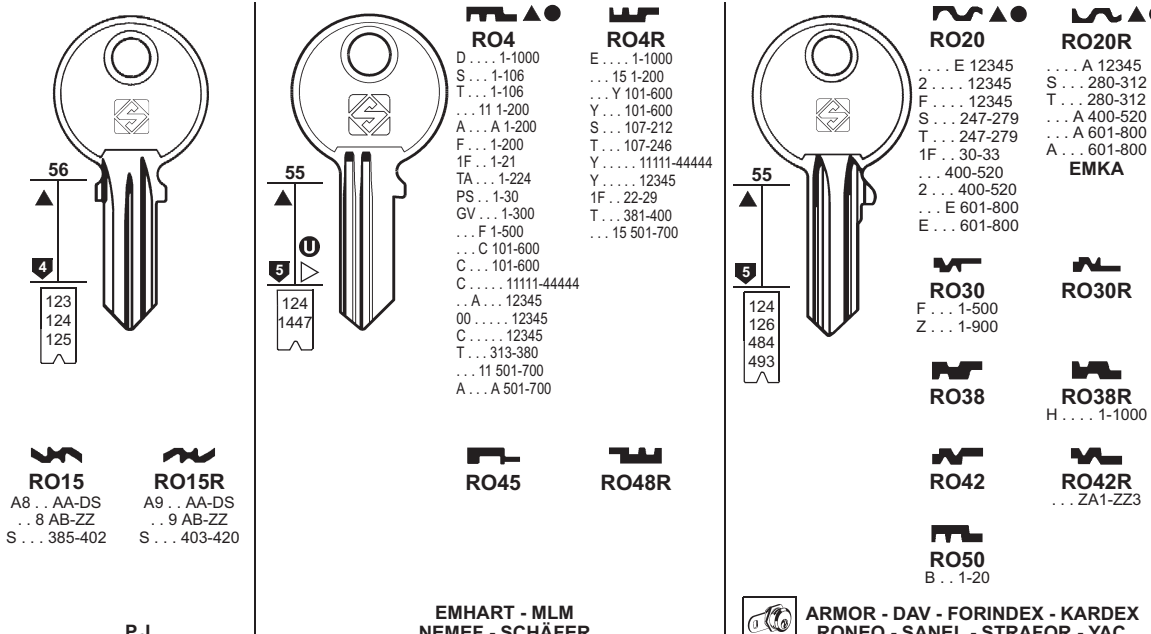

**RO4**  
D ... 1-1000  
S ... 1-106  
T ... 1-106  
... 11 1-200  
A ... A 1-200  
F ... 1-200  
1F ... 1-21  
TA ... 1-224  
PS ... 1-30  
GV ... 1-300  
... F 1-500  
... C 101-600  
C ... 101-600  
C ... 11111-44444  
... A ... 12345  
00 ... 12345  
C ... 12345  
T ... 313-380  
... 11 501-700  
A ... A 501-700

**RO4R**  
E ... 1-1000  
... 15 1-200  
... Y 101-600  
Y ... 101-600  
S ... 107-212  
T ... 107-246  
Y ... 11111-44444  
Y ... 12345  
1F ... 22-29  
T ... 381-400  
... 15 501-700

**RO20**  
... E 12345  
2 ... 12345  
F ... 12345  
S ... 247-279  
T ... 247-279  
1F ... 30-33  
... 400-520  
2 ... 400-520  
... E 601-800  
E ... 601-800

**RO20R**  
... A 12345  
S ... 280-312  
T ... 280-312  
... A 400-520  
... A 601-800  
A ... 601-800

**EMKA**

**RO30**  
F ... 1-500  
Z ... 1-900

**RO30R**

**RO38**

**RO38R**  
H ... 1-1000

**RO42**

**RO42R**  
... ZA1-ZZ3

**RO50**  
B ... 1-20



ARMOR - DAV - FORINDEX - KARDEX  
RONEO - SANEL - STRAFOR - YAC

PER:  
FOR:

# RONIS

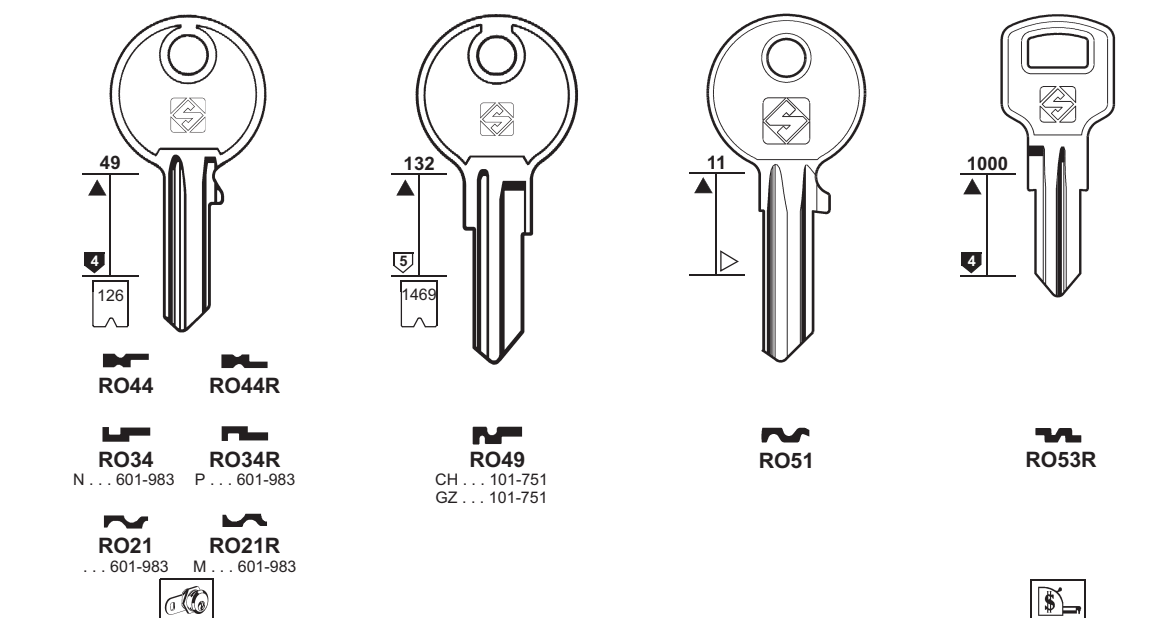

**RO44**   **RO44R**

**RO34**   **RO34R**  
N ... 601-983   P ... 601-983

**RO21**   **RO21R**  
... 601-983   M ... 601-983

BURG - STRAFOR - TAV

**RO49**  
CH ... 101-751  
GZ ... 101-751

**RO51**

**RO53R**





# 148

PER / FOR

**ROSSETTI** (R)

**ROSTEX** (CZ)

LOB (114)

**ROYAL** (RC)

ABUS (8)

COLE (52)

GUARD (90)

VIRO (187)

YETI (198-199)

**R.S.M.** (GB)

P.C.

CORTELEZZI (140)

**RUFFLER &**

**DEITH** (GB)

SIDLEEN (154)

**RUFFLER &**

**WALKER** (GB)

SIDLEEN (154)

**RUKA** (D)

DOM (61)

VACHETTE (182)

**RUKO** (DK)

ASSA

DIFA

**RUSSIA** (RUS)

**RUSSWIN** (USA)

## PER: ROSSETTI

FOR:

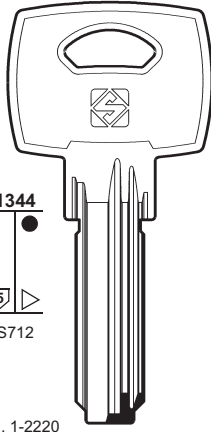

... 1-2220



## RUKO

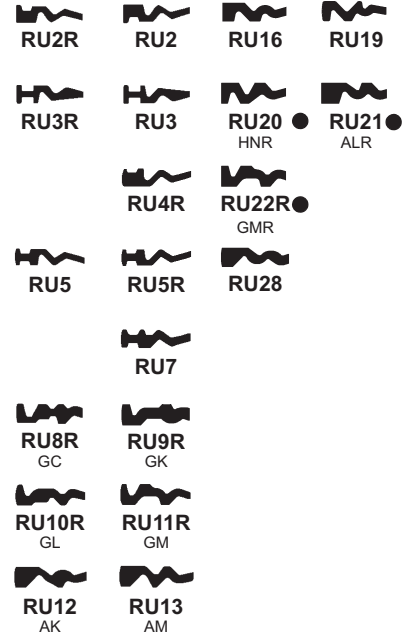

**RU1**  
..... 1-2-3-4-5-6-7-8  
..... 1-2-3-4-5-6-7-8-9  
..... 1-2-3-4-5-6-7-8-9-0-A-B  
..... 0-1-2-3-4-5-6-7-8-9-A-B-C-D-E-F-G-H-L-M  
S..... 1-2-3-4-5-6-7-8-9

**RU1R**

**DIFA**

## PER: RUKO

FOR:

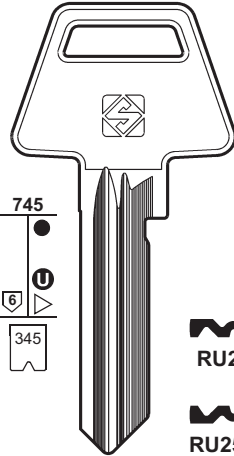

**RU14**  
..... ABCDEFGHJ



ASSA

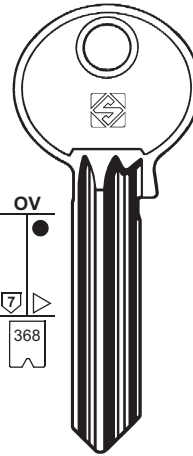

1-2-3-4-5-6-7-8-9-A-B-C

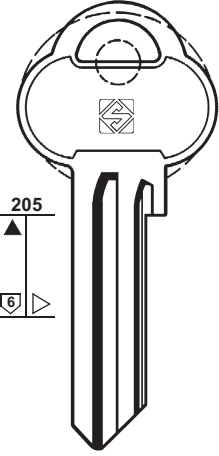

## PER: RUSSIA

FOR:

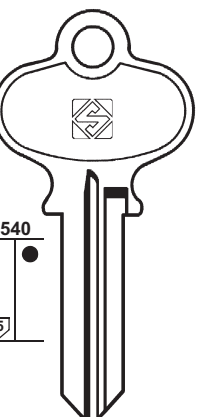
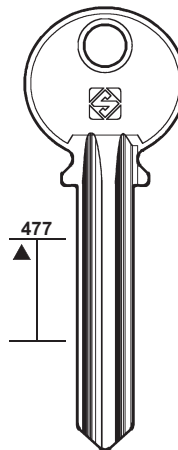
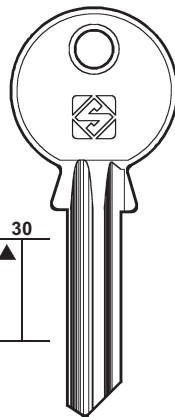
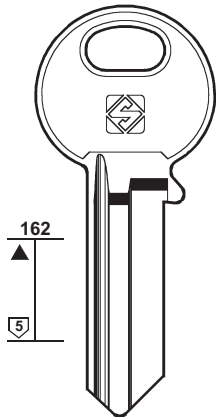

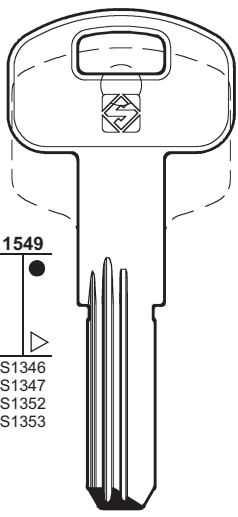
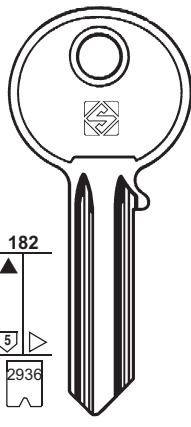
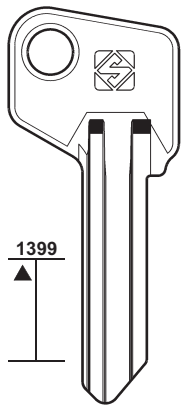
PER: FOR:	S-TECH	SABI	SAM
	 <p>1549</p> <p>S1346 S1347 S1352 S1353</p> <p>SCH1R</p>	 <p>182</p> <p>5</p> <p>2936</p> <p>..... 01234567</p> <p>SB1</p>	 <p>1399</p> <p>SMA1</p>

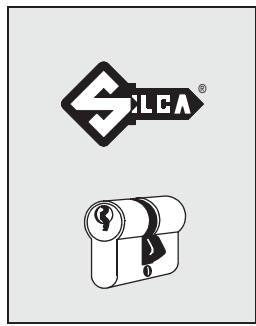

# 149

- PER / FOR
- S-TECH** (GB)
  - SAB** (I)  
👁️ TAMPALINI (164)
  - SABI** (ET)
  - SAFE** (I)
  - SAM** (RUS)
  - SAMA** (F)  
👁️ FTH (82)
  - SAMSONITE** (USA)
  - SANCHUN** (RC)  
👁️ YETI (198-199)
  - SANEL** (F)  
👁️ RONIS (147)
  - SANPEUR** (F)  
👁️ VACHETTE (180)
  - SÄNTIS** (CH)  
+ 👁️ CES (41-42)
  - SANTOS** (P)  
👁️ OMEC (135)  
👁️ P.C. (CORTELLEZZI) (139)
  - SANWA** (J)
  - SANY** (F)  
👁️ ALPHA (15)

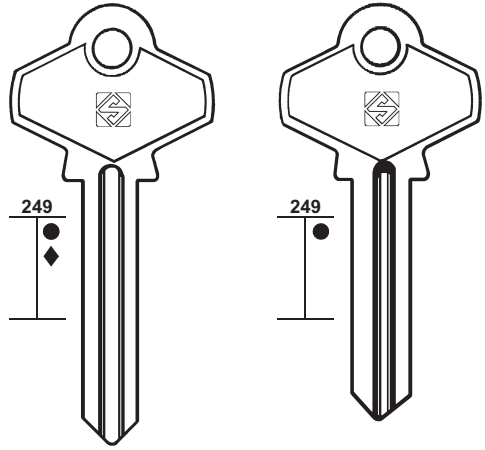
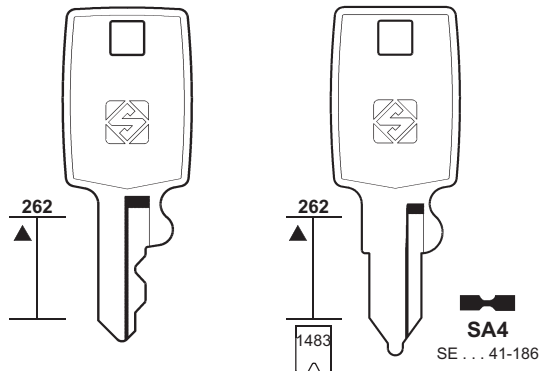
PER: FOR:	SAFE	SAMSONITE
	 <p>249</p> <p>SF1</p> <p>SF2</p>	 <p>262</p> <p>1483</p> <p>SA4 SE ... 41-186</p> <p>SA1 170 S    SA1R</p> <p>SA2 70 S    SA2R</p> <p>SA3 SE ... 315-396    SA3R SE ... 231-294</p> <p>SA5    SA5R</p>

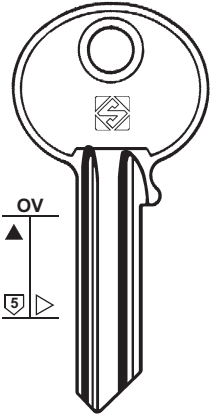
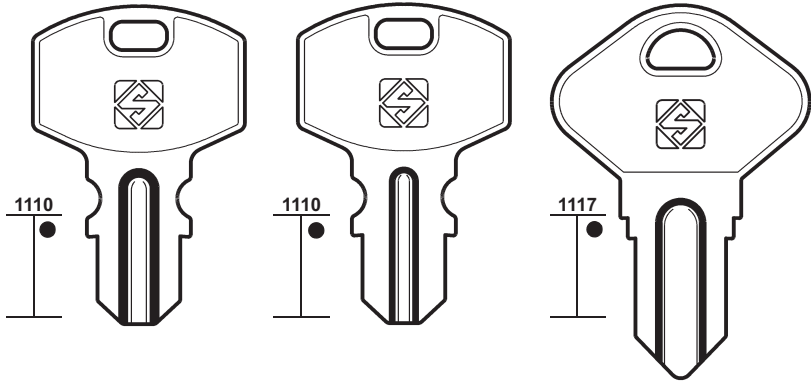
PER: FOR:	SÄNTIS	SANWA
	 <p>OV</p> <p>SAN1    SAN1R</p>	 <p>1110</p> <p>1110</p> <p>1117</p> <p>SNW1    SNW2    SNW3</p>



# 150

PER / FOR

**SARATOV** (RUS)

**SARGENT** (USA)  
BRICARD  
KESO  
SHOWA

**SARGENT & GREENLEAF** (USA)  
SLAYMAKER (157)

PER:  
FOR:

## SARATOV

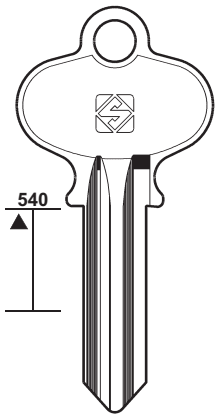

  
**SRT1**

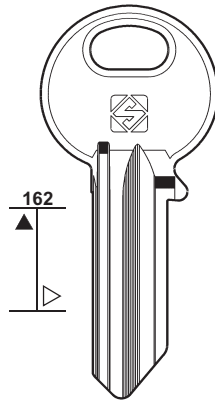

  
**SRT2**

## SARGENT

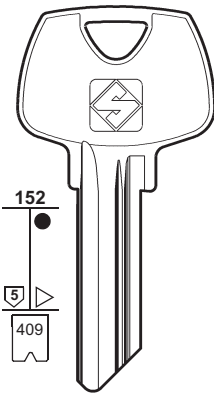



 **SAR8**      **SAR17**

.....  
1-2-3-4-5-6-7-8-9-0

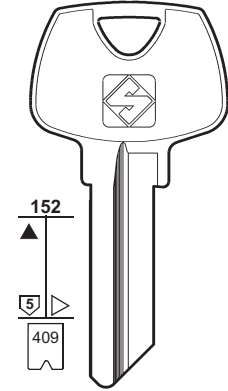

PER:  
FOR:

## SARGENT



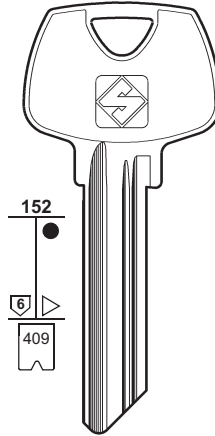

  
**SAR17R**  
.....  
1-2-3-4-5-6-7-8-9-0

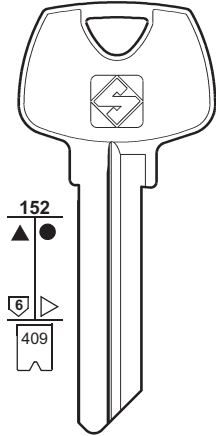

 **SAR21**      **SAR3**  
.....  
1-2-3-4-5-6-7-8-9-0



 **SAR3R**  
.....  
1-2-3-4-5-6-7-8-9-0  
 **SAR22R**  
 **SAR21R**

PER:  
FOR:

## SARGENT

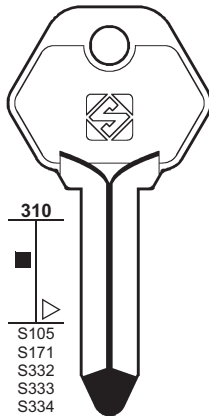

S105  
S171  
S332  
S333  
S334  
S335  
S336  
S598  
S599  
S600  
S601  
 **KE4**

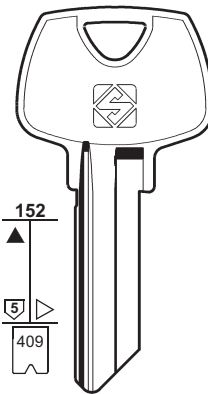

 **SAR1**  
S  
.....  
1-2-3-4-5-6-7-8-9-0

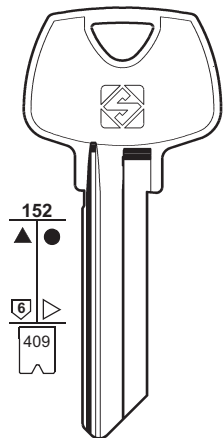

 **SAR2**      **SAR4R**  
S  
.....  
1-2-3-4-5-6-7-8-9-0

BRICARD - SHOWA

BRICARD - SHOWA

SATURN			SAVE	
OV ▲ 587	37 ▲ 5	1346 ● S1103	1047 ▲	1329 ▲
STU1	STU3	STU6R	SVE1R	SVE2R
1-2-3-4-5-6-7-8-9	mm 50	BASI		
GERA - VERA				



# 151

PER / FOR
<b>SATURN</b> (SLO) BASI GERA VERA
<b>SAVE</b> (CZ)
<b>SAVIO</b> (I) AGB (11) JVAL (102) P.C. (CORTELLEZZI) (139)
<b>SCHÄFER</b> (D) RONIS (147)
<b>SCHÄRF</b> (D) HUWIL (94)
<b>SCHLAGE</b> (I) (USA) BALDWIN EPO TACO

SCHLAGE				
249 ●	583 ●	301 ▲	301 ●	301 ●
SH1 A	SH2 W	SH5R	SH27	T SH12R
EPO		A/Z ..... 0123456789 A/Z-A/Z ..... 0123456789		A/Z ..... 0123456789 A/Z-A/Z ..... 0123456789

SCHLAGE	
	<p>..... 0123456789 C </p> <p>..... A 0123456789 <b>SH3</b></p> <p>S ..... 100-27787 <b>BALDWIN</b></p> <p>CE </p> <p>● SH17</p> <p>E </p> <p>● SH11</p> <p>EF </p> <p>▲ SH8</p> <p>F </p> <p>▲ SH9</p> <p>FG </p> <p>● SH18</p> <p>G </p> <p>▲ SH12</p> <p>H </p> <p>● SH13</p> <p>J </p> <p>▲ SH14</p> <p>K </p> <p>▲ SH15</p> <p>L </p> <p>SH16</p> <p>A/Z ..... 0123456789</p> <p>A/Z-A/Z ..... 0123456789</p>
301 ▲	
410 546	
TACO	



# 152

**PER / FOR****SCHLAGE** (I) (USA)  
BALDWIN  
TACO**SCHLECHTENDAHL** (D)  
CASI  
HUTRA  
NORDWEST**SCHLEGEL** (D)  
DOM (61)**SCHÜCO** (D)  
CISA (48)  
KFV (105)**SCHULTZ** (D)  
EURO LOCKS (71)**S & E** (F)  
PICARDIE (141)**SE** (F)  
G.R. (89)**SEA** (CH)  
EZCURRA  
HASLER  
VIDMAR**SEAT** (I)  
MICHEL  
SICCAF**SECURE** (GB)  
STA-LOCKPER:  
FOR:

## SCHLAGE

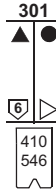
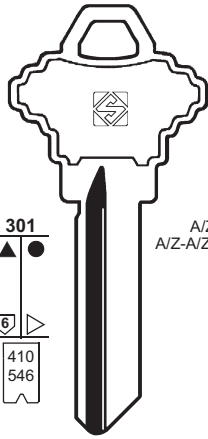
A/Z ..... 0123456789  
A/Z-A/Z ..... 0123456789

- ..... DG C **SH5**  
BALDWIN
- CE **SH23**
- E **SH10**
- EF **SH6**
- F **SH7**
- FG **SH24**
- G **SH19**

A/Z ..... 0123456789  
A/Z-A/Z ..... 0123456789

TACO

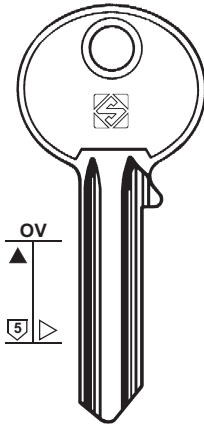
**PER: FOR: SCHLECHTENDAHL****SEA****ST1**

CASI - HUTRA - NORDWEST

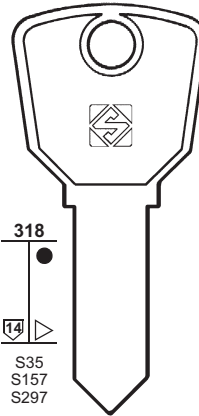
**SEB1**  
20-23

EZCURRA - HASLER

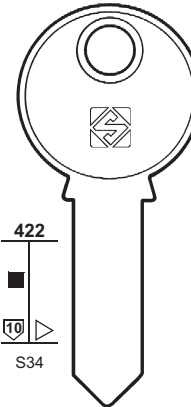
**SEB2**

EZCURRA - HASLER - VIDMAR

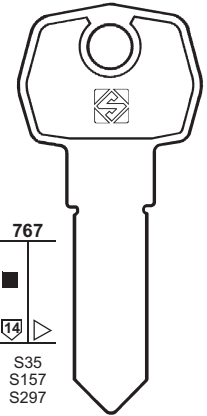
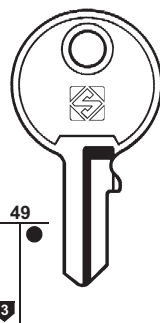
**SEB3**  
20-23**PER: FOR: SEAT****SECURE****SEA4****SEA4R**

MICHEL - SICCAF

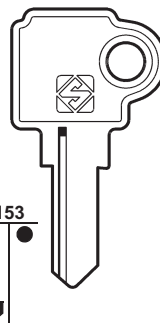
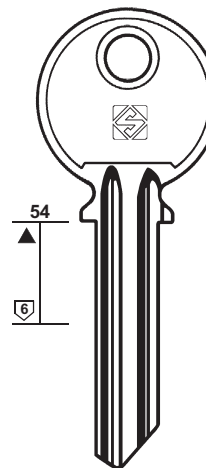
**SEA5****SEA5R****SEA7****SEA8****SC1**

STA-LOCK

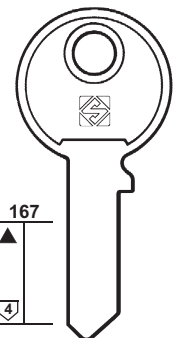
**SC2**

STA-LOCK



PER:  
FOR:

# SECUREMME

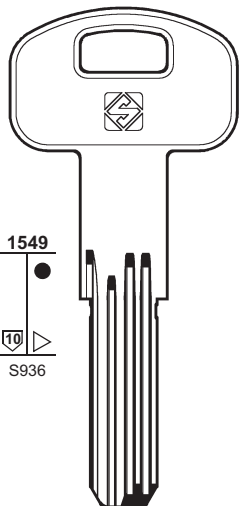

**SCM1R**  
K2

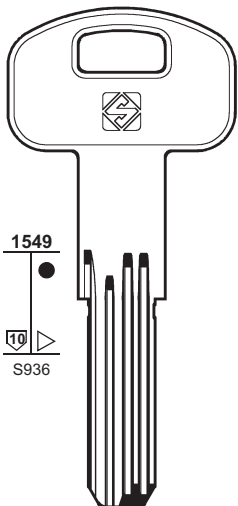

**SCM2**  
K1

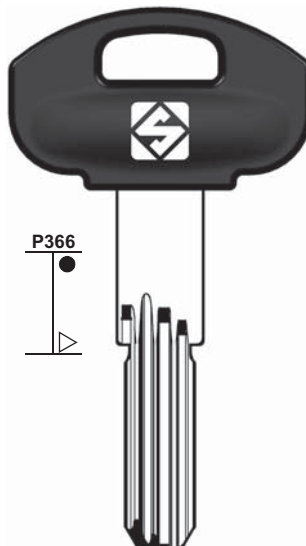

**SCM3RP**



# 153

PER / FOR

**SECUREMME (I)**

**SECURITAL (I)**

KYR  
+ ABUS (9)  
+ FORT (81)

**SEEBURG (USA)**

ILLINOIS (96)

**SEGAL (USA)**

HUDSON  
READING

**SEIM (F)**

KIFERM (106)

**SELECT (F)**

**SELMACH (RUS)**

**SEMEL (F)**

JIS (99)

**SEN (D)**

KFV (105)

**SERITAL (I)**

PREFER (142)

**SERRALLER (E)**

AGA (11)

**SES (F)**

MELSMETAL (122)

**SESA (F)**

RONIS (146-147)

**SEZAN (RC)**

YETI (198-199)

**SHANGHAI (PRC)**

CINA  
+ CINA (48)

PER:  
FOR:

## SECURITAL

## SEGAL

## SELECT

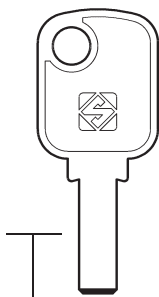

ZAMA  
S39  
S612  
S760  
S761  
S1265  
S1391  
**SCU1**

KYR

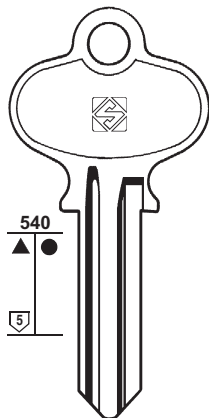

**SL1**  
A  
K9

HUDSON - READING

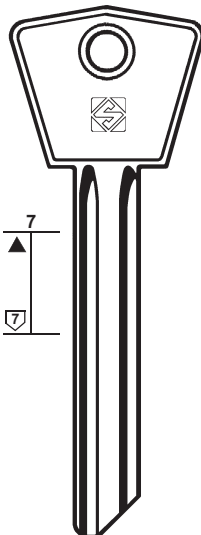

**SE8**

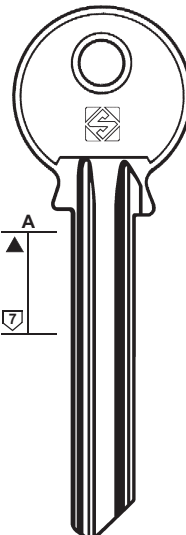

**SE7**

**SE7R**

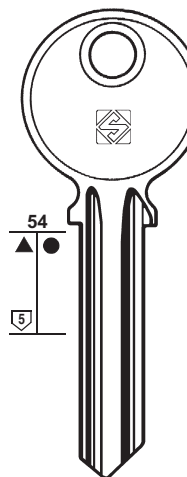

**SE5**

**SE5R**

PER:  
FOR:

## SELECT

## SELMACH

## SHANGHAI

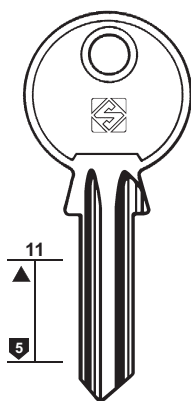

**SE3**

**SE3R**

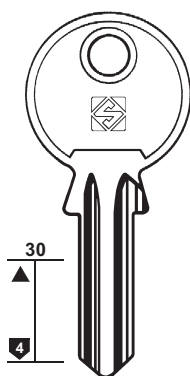

**SE1**

**SE1R**

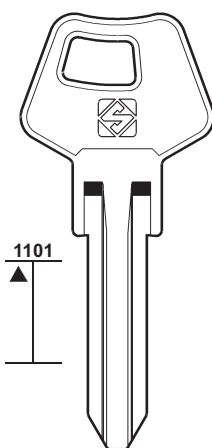

**SEM1**

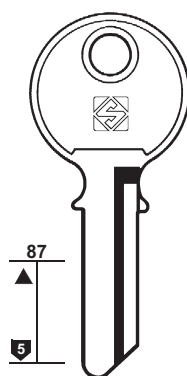

**SG1**

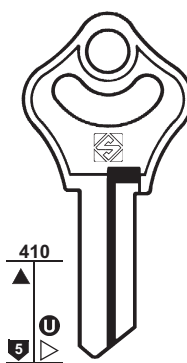

**SG808**

**SG808R**



CINA





# 154

**PER / FOR****SHAW** (GB)  
+ HTV (93)**SHILUTE** (RUS)**SHOWA** (J)  
+ SARGENT (150)**SIAM** (DZ)  
+ CITY (51)  
+ SIMECA (155)  
+ ZENITH (201)**SICCAF** (I)  
+ SEAT (152)**SICMA** (F)  
+ ZENITH (201)**SIDLEEN** (GB)  
BANHAM  
EXCEL  
REGENT  
RUFFLER & DEITH  
RUFFLER & WALKER**SIEBAU** (D)  
+ CES (42)  
+ TOK-WINKHAUS (170)**SIGENIA** (D)  
+ POS (141)**SIGMA** (PL)**SIL** (P)

PER: FOR:	SHAW	SHILUTE	SHOWA
	 SHW1	 SHW2	 SHT1
			 SWA10

PER: FOR:	SHOWA	SIAM	SIDLEEN
	 SWA1 1-2-3-4-5-6-7-8-9	 SIA1R	 SD1
			EXCEL

PER: FOR:	SIDLEEN	SIGMA	SIL
	 SD2 BANHAM RUFFLER & DEITH RUFFLER & WALKER REGENT	 SD3T	 SGM1
			 SIL1R

PER: FOR: **SILCA** **SILVANA**

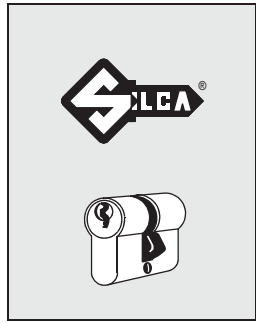
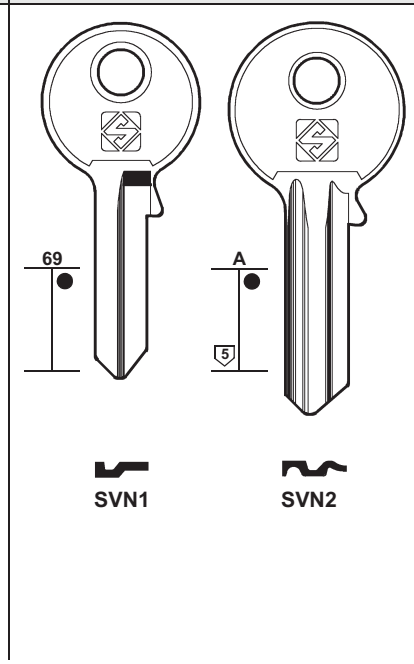
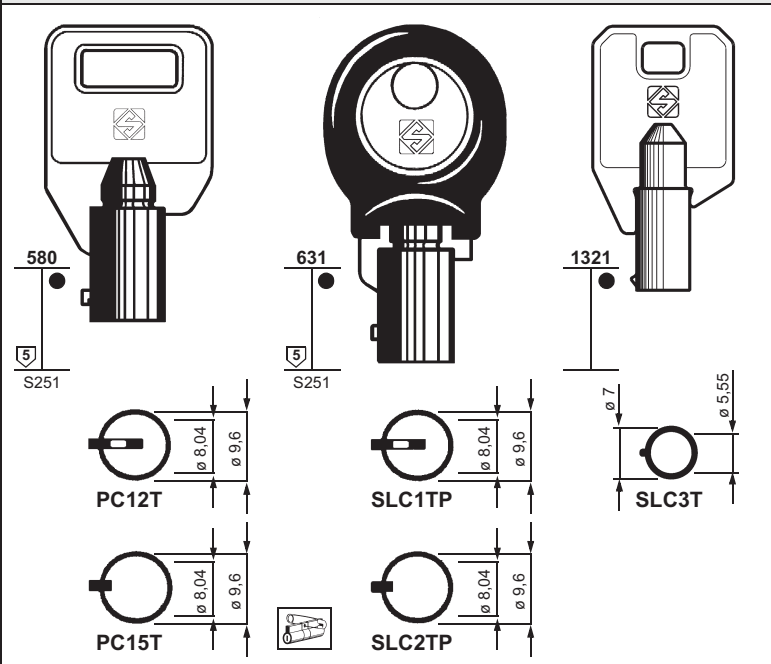

**155**

PER / FOR  
**SILCA** (I)  
 + P.C. CORTELLEZZI (140)  
**SILVANA** (BR)  
**SIMATIC** (CH)  
 SIMECA (155)

PER: FOR: **SIMECA**

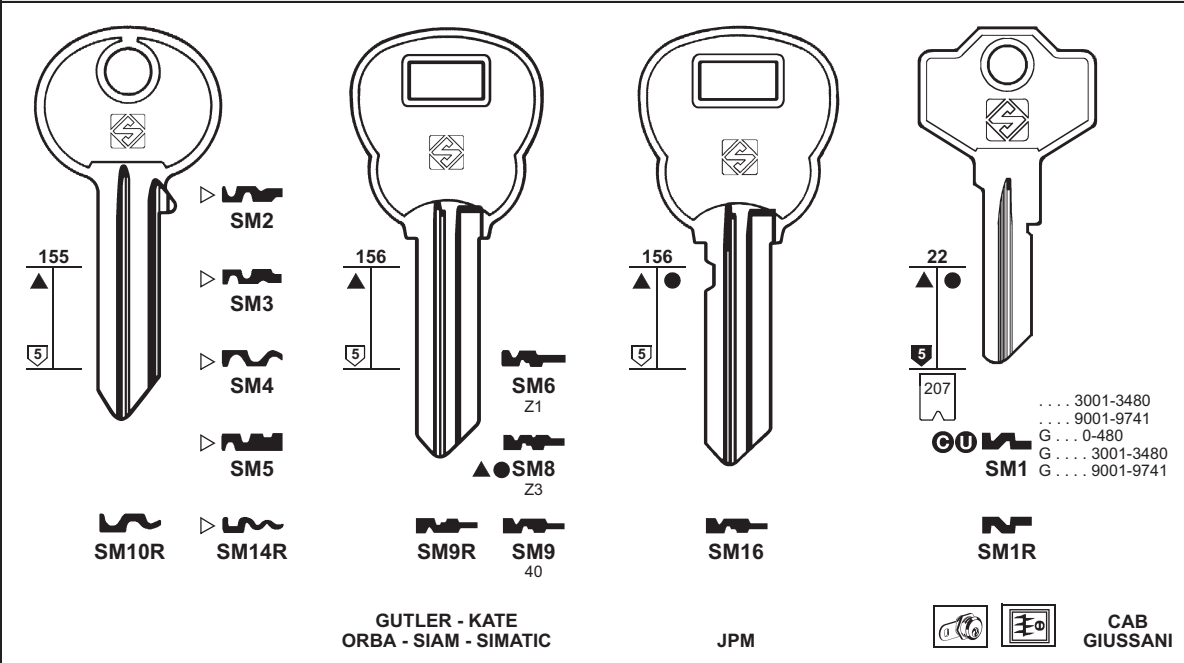

**SIMECA** (CH)  
 CAB  
 GIUSSANI  
 GUTLER  
 JPM  
 KATE  
 ORBA  
 SIAM  
 SIMATIC  
**SINA** (I)  
 ZANI (200)  
**SINJET** (D)  
 DOM (61)  
**SIS** (I)  
 ZENITH

PER: FOR: **SIMECA** **SIS** (I)

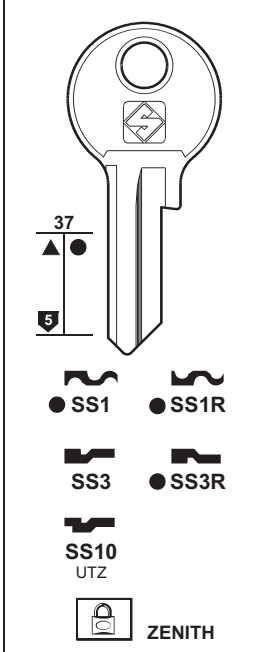
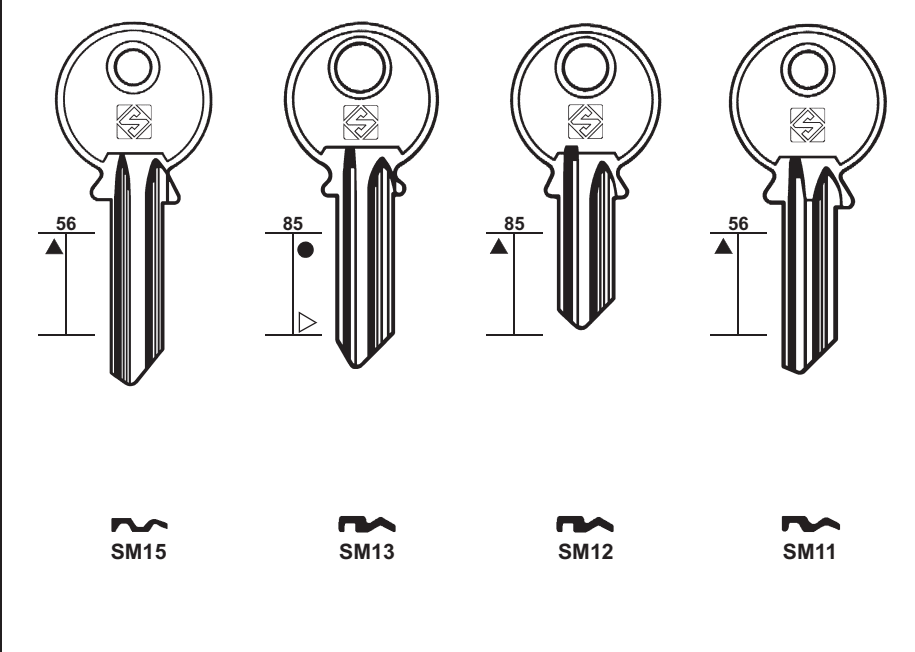



# 156

### PER / FOR

**SIS (I)**  
FEL  
LÄSBOLAGET  
PICARDIE

### SIS (P)

**SISO (I)**  
+ CAS-CISMA (40)  
+ EVERGOOD (71)  
+ OJMAR (134)

### SJL (RUS)

**SKILLMAN (USA)**  
CORBIN (54)

PER:  
FOR:

**SIS (I)**

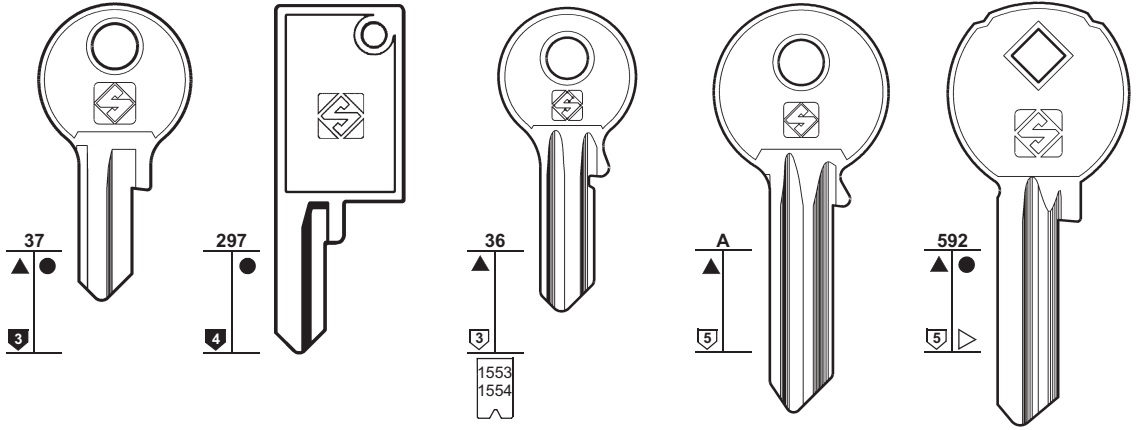

**SS9**

**SS6**

**SS14 SS14R**  
... 7654321

**SS12**

**SS7 ●SS7R**



PICARDIE

LÄSBOLAGET

PER:  
FOR:

**SIS (I)**

**SIS (P)**

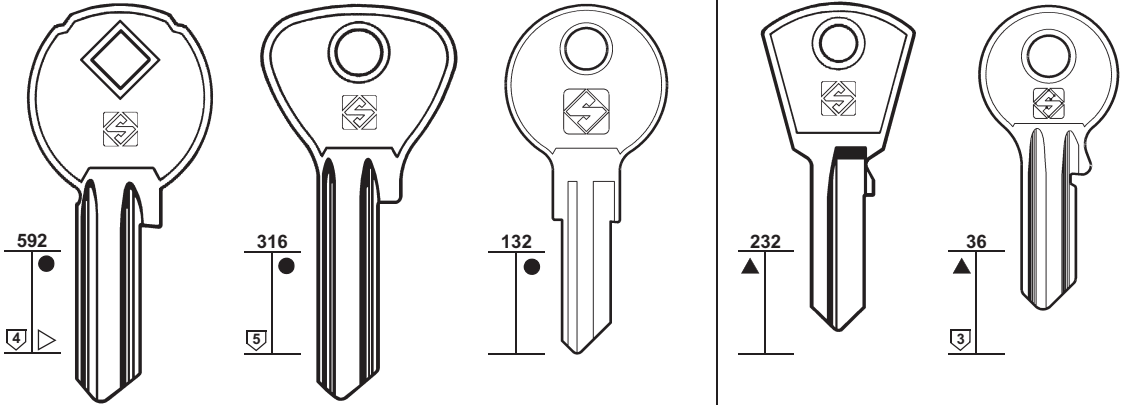

**SS8**

**SS4**

**SS13**

**SSP1**

**SSP5**

**SSP1R**

PER:  
FOR:

**SIS (P)**

**SISO**

**SJL**

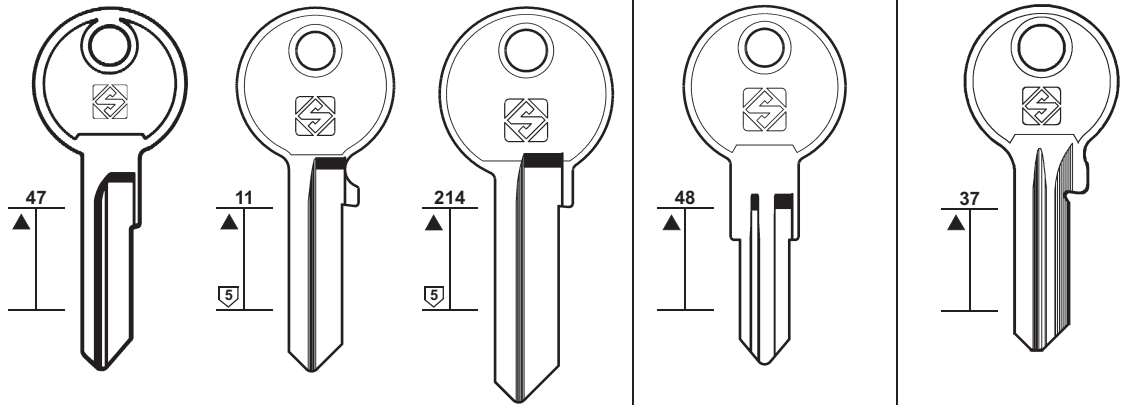

**SSP2**

**SSP4 SSP4R**

**SSP6**

**SSO1 SSO2**

**SJ1R**



PER: FOR:	SKMZ	SLAYMAKER	SOBINCO	
	 CKM1	 SY1	 SN3R	 SN4R
		SARGENT & GREENLEAF		

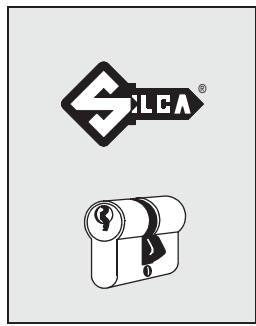

# 157

PER / FOR
SKMZ (UA)
SLAYMAKER (USA) SARGENT & GREENLEAF
SOBINCO (B) +  SOFI-SONAFI (157)
SOF (F) GLOBE (87-88)
SOFER (P)
SOFI-SONAFI (P) CHAVO SOBINCO
SOFRANQ (F) RONIS (146)

PER: FOR:	SOBINCO	SOFER	SOFI-SONAFI
	 ● SN5R 012345678		 CHAVO

PER: FOR:	SOFI-SONAFI				
					SOBINCO



# 158

PER / FOR

**SOLER** (E)

**SOLID** (RSA)

CES (42)

**SOLOR** (F)

RONIS (147)

**SONICO** (BG)

**SOPRANO** (BR)

## SOLER

PER:  
FOR:

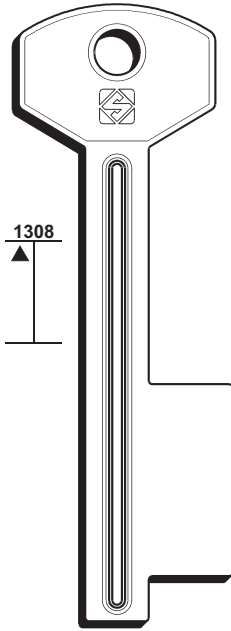

SLR1

## SONICO

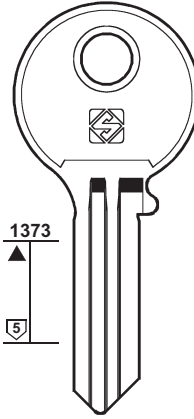

SNC1



SNC2



SNC2R

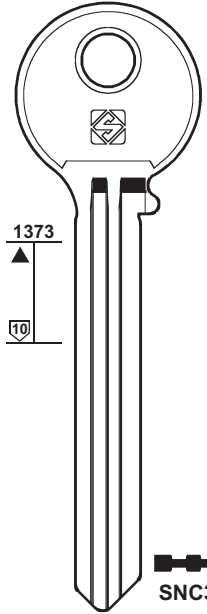

SNC3

## SOPRANO

PER:  
FOR:

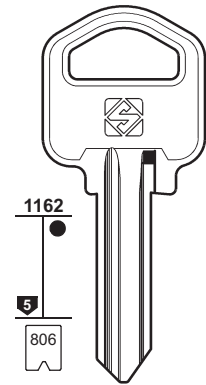

SOP1

.....  
1-2-3-4-5-6-7-8-9

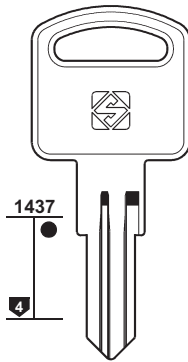

SOP2

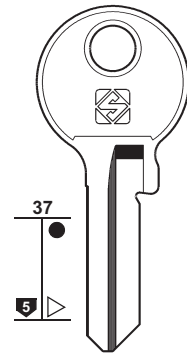

SOP10

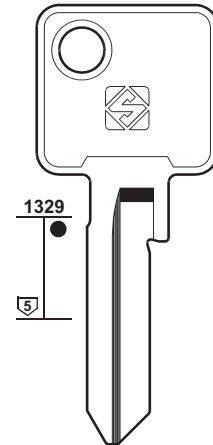

SOP11

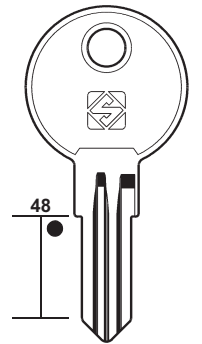

SOP12

## SOPRANO

PER:  
FOR:

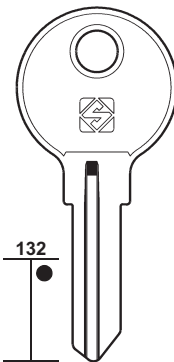

SOP15R

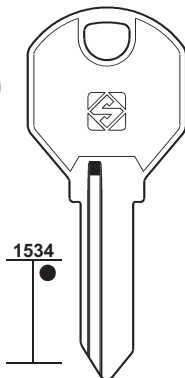

SOP13R

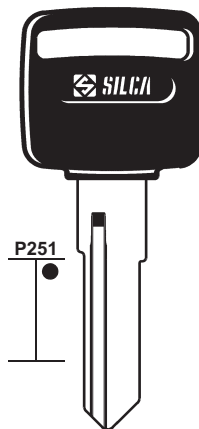

SOP14RP

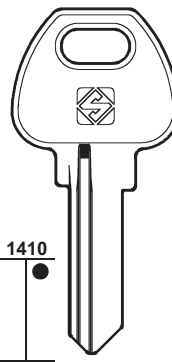

SOP16R

.....  
1-2-3-4-5

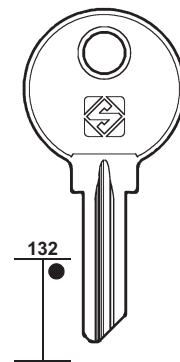

SOP17R

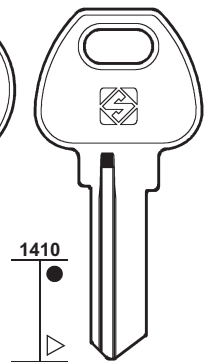

SOP18R

PER:  
FOR:

### SOS

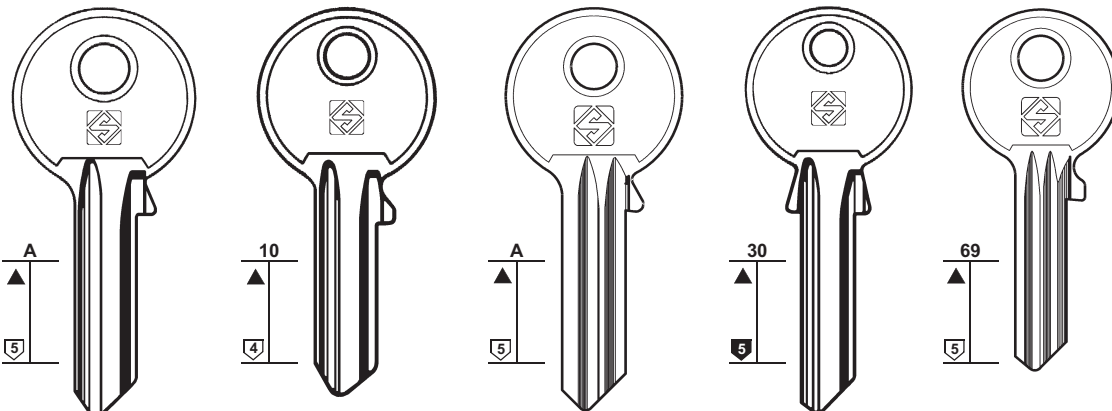

# 159

PER / FOR

#### SOS (F)

- + CITY (51)
- + GABON (84)
- + MING-TAY (126)
- + TESA (165)
- + YALE (195)

#### SOUTHCO (GB)

- YALE (194)

#### SP (F)

- FTH (81)
- MUL.T.LOCK (131)

#### SPEEDAL (I)

- CES (43)

#### SPIDER (IL)

- CAVERS
- CODKEY

#### SQUIRE & SONS (GB)

#### SS (D)

- CES (42)

#### STA-LOCK (GB)

- SECURE (152)

PER:  
FOR:

### SOS

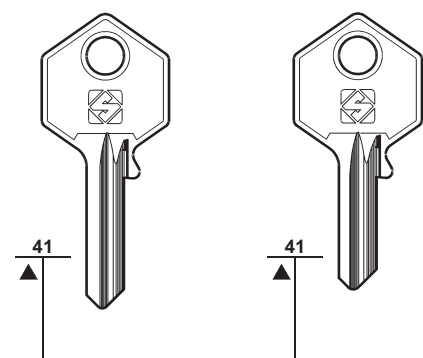

### SPIDER

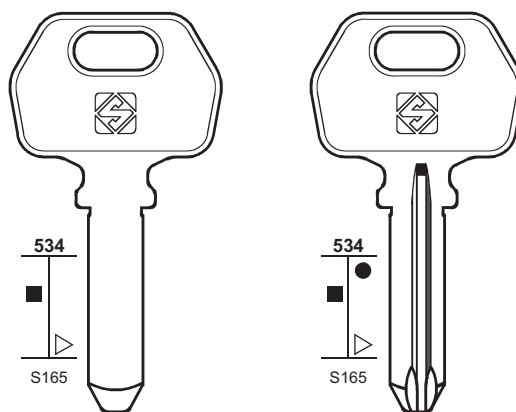

PER:  
FOR:

### SQUIRE & SONS

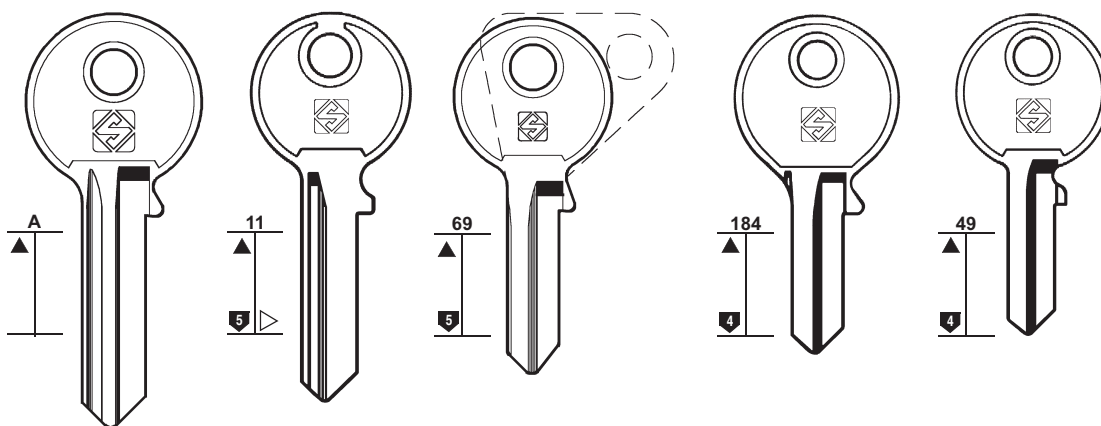



# 160

PER / FOR

STAM (BR)

STANDARD (D)

CISA (48)

STANOFDRO (PRC)

PER:  
FOR:

## STAM

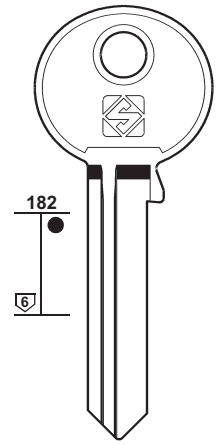
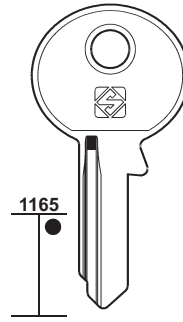
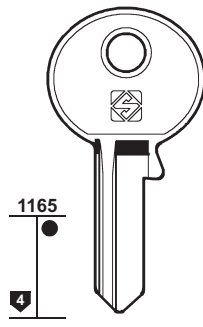
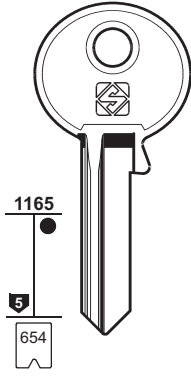

SAM14

SAM9R

SAM1 SAM1R ①  
..... 1-2-3-4-5-6-7-8

SAM15R

SAM13 SAM13R

SAM4

PER:  
FOR:

## STAM

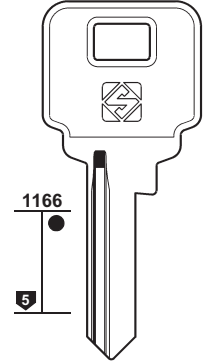
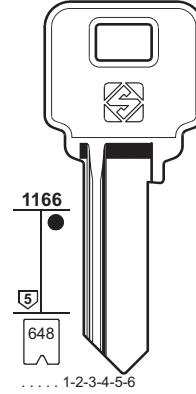
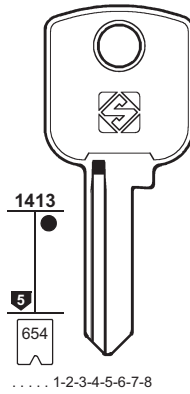
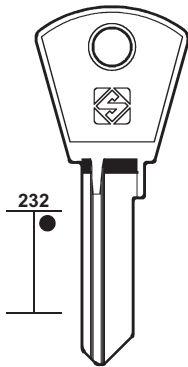

SAM16R

SAM2

SAM3R

SAM6

SAM12R

SAM2R

PER:  
FOR:

## STAM

## STANOFDRO

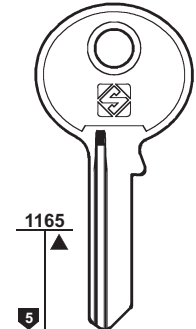
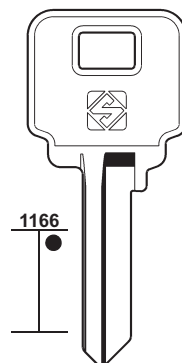
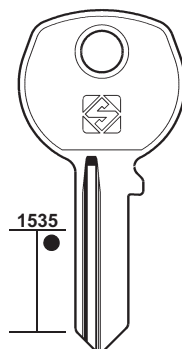
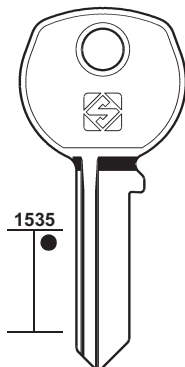

SAM10

SAM11R

SAM8

SFD1R



PER:  
FOR:

### STAR

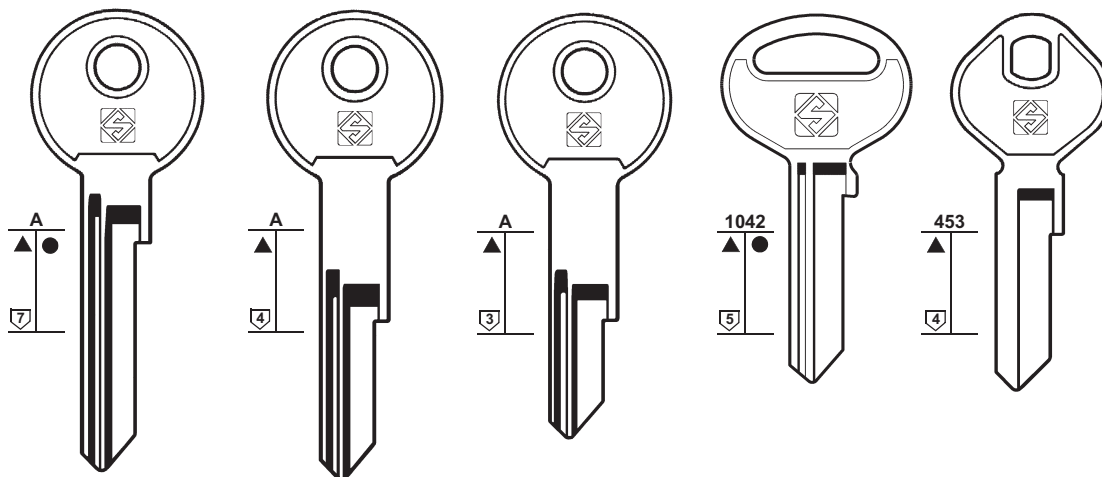

  
   
   
 ●   



# 161

PER / FOR

**STAR (J)**  
GS  
IJ  
TEC  
+ ISEO (97)

**STARLET (D)**  
GERA

**STARRY (NL)**

**STEELCASE (USA)**  
 CHICAGO (45)  
 HUWIL (94)

**STEIGA (D)**  
 DOM (62)

**STIQAM (TN)**  
 CAS-CISMA (40)

PER:  
FOR:

### STAR

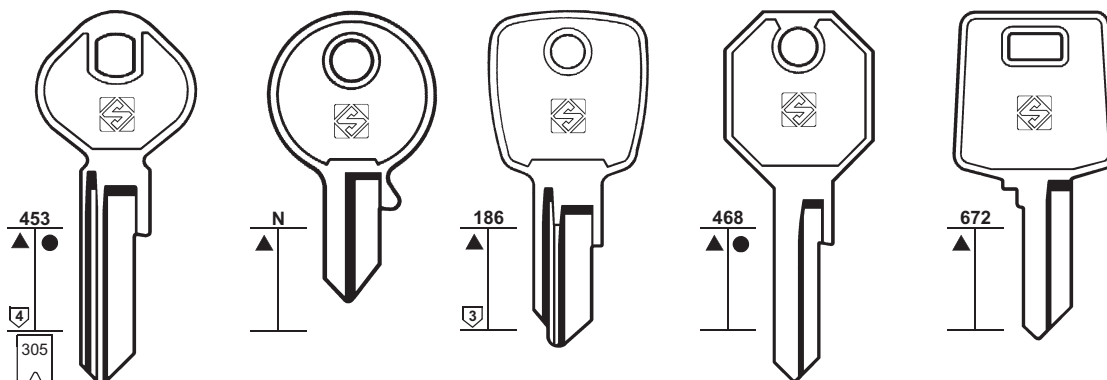

K... 1-1600



PER:  
FOR:

### STARLET

### STARRY

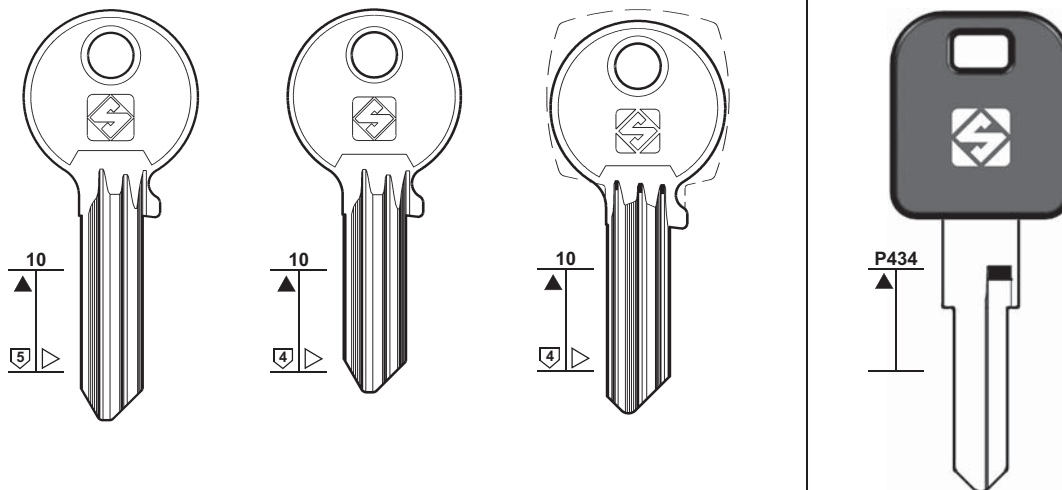

GERA





# 162

PER / FOR

**STORWALL** (GB)

**STRAFOR** (GB)

- HUWIL (94)
- LAS (110)
- RONIS (147)

**STREBOR** (GB)

**STREMLER** (F)

- BRICARD (35)
- CAS-CISMA (40)
- CORBIN (53)
- RONIS (146)

**STS** (E)

ALSO  
ARFE  
BTV

- + ARFE (17)
- + DOM (61-62-63)
- + ELCA (68)
- + PICARDIE (141)
- + TESA (166)

**STUBLINA** (SCG)

**STUMPF** (D)

- + OJMAR (134)

PER: **STORWALL**

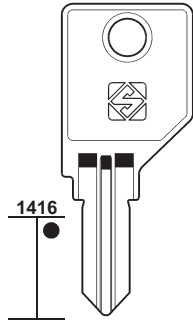

**SWL1**



PER: **STREBOR**

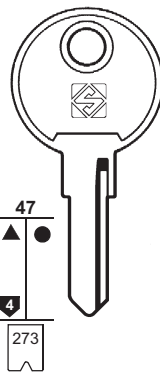

**STR5**  
F... 402-480

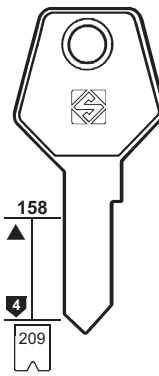

**STR3**  
S... 1-70

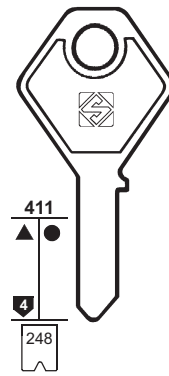

**STR4**  
RR... 502-579

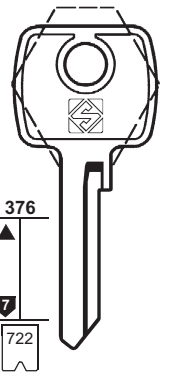

**STR6**  
MT... 1-989



PER:  
FOR:

**STS**

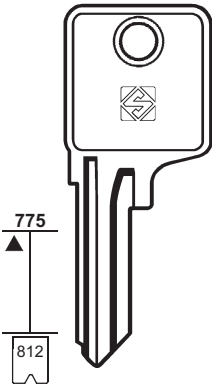

**STS1 STS1R**  
.....  
(625) 0-1-2-3-4-5



ALSO

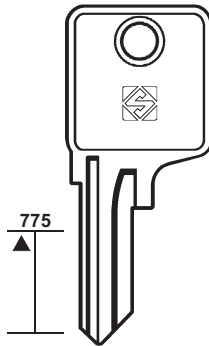

**STS2 STS2R**

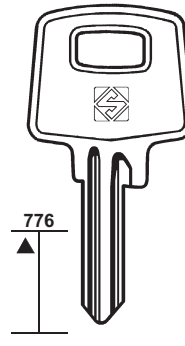

**STS3**



BTV

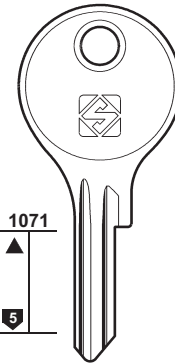

**STS4**

ARFE

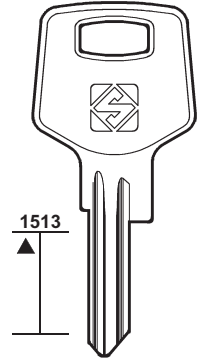

**STS11**

PER:  
FOR:

**STS**

**STUBLINA**

**STUMPF**

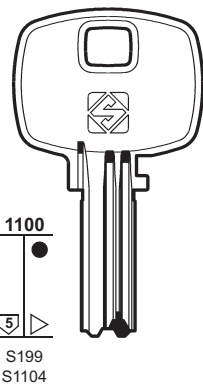

S199  
S1104

**STS5**

K... 5001-8030

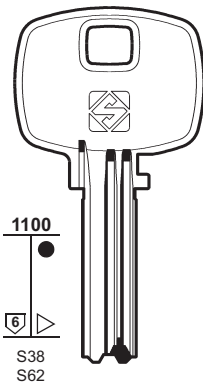

S38  
S62  
S199  
S436  
S1104

**STS6** ⊕

J  
K

P... 5001-8030  
K... 5001-8030

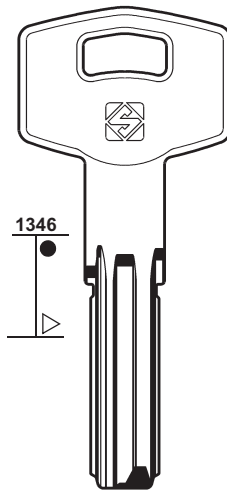

**STS9**

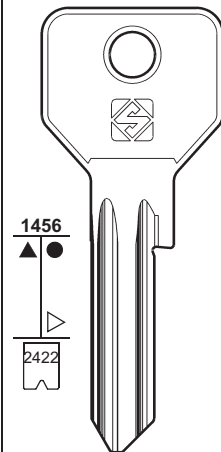

**STN1**

**STN1R**

..... 12345678

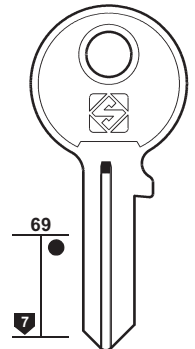

**STF1**

**STF1R**

PER:  
FOR:

# STUV

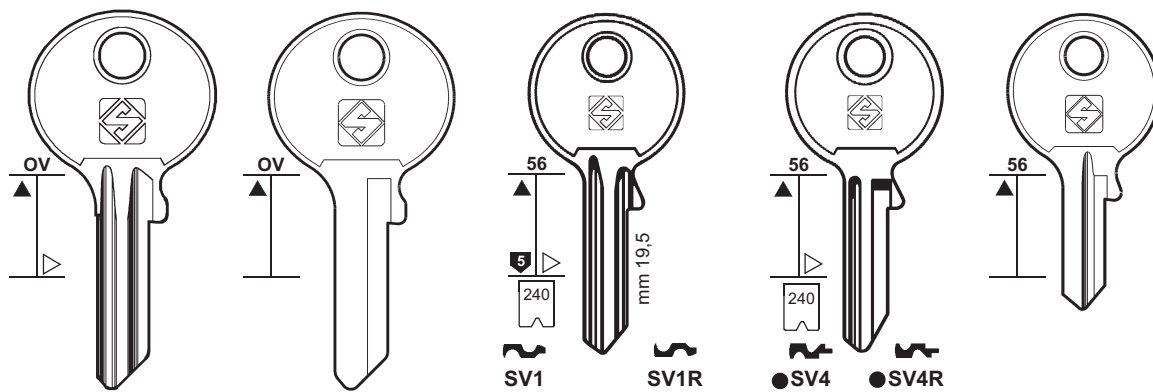

**SV1**  
2F ... 201-278  
1F ... Z 201-278  
1F ... X 201-278

**SV1R**  
1F ... 201-278  
1F ... Z 201-278  
1F ... X 201-278

**SV4**  
**SV4R**  
**SV5R**

**SV3** **SV3R**

**SV7**

**SV2R**

**SV2**

**SV8** **SV8R**

2F ... 201-278  
1F ... Z 201-278  
1F ... X 201-278

**SV6R**



MLM - DOM



# 163

PER / FOR

**STUV (D)**  
DOM  
MLM  
+ CES (41-42)  
+ DOM (62)  
+ MLM (127)

**STV (I)**  
 OMIV (136)

**SUF (F)**  
 FTH (82)

**SUKI (J)**  
 FLORA (81)

**SUL (I)**  
 CORBIN (53)  
 P.C. CORTELLEZZI (140)

**SUNSUI (RC)**

**SUPER (RC)**

**SUREX (F)**  
ATLAS  
EUROP  
MATTEY  
+ GABON (84)  
+ YALE (194)

**SURFINOR (F)**  
 FICHET (80)

**SUYOKA (J)**  
 AGA (10)

**SWAN (I)**  
 YETI (198-199)

PER: **SUNSUI**  
FOR:

**SUPER**

**SUREX**

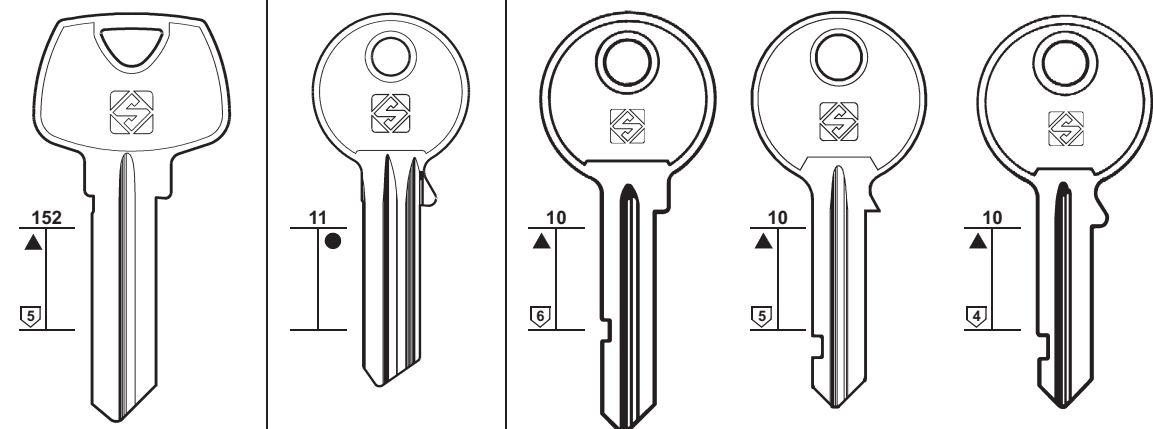

**SU1R**

**SPU1R**

**SR8**

**SR7**

**SR6**

PER:  
FOR:

# SUREX

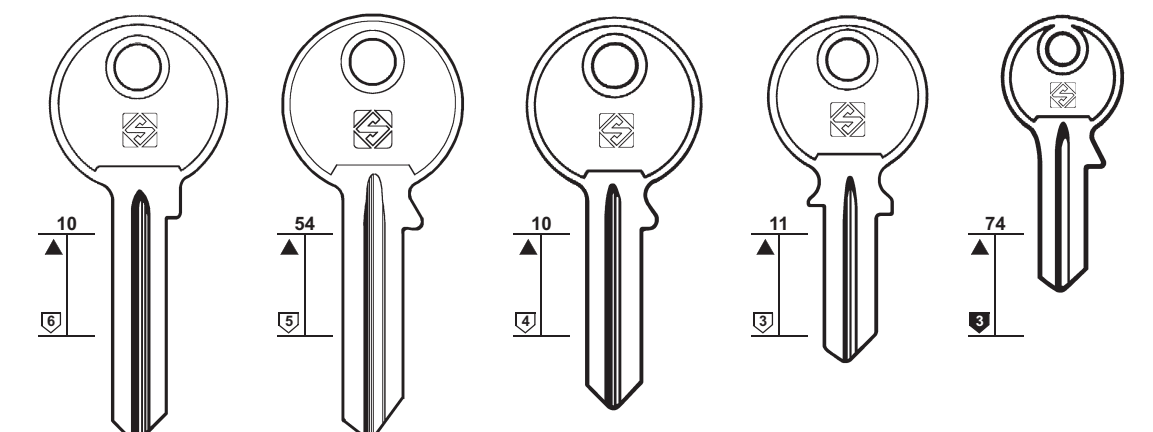

**SR10R**

**SR4**

**SR11R**

**SR2**

**SR2R**

**SR9R**



ATLAS

ATLAS - EUROP  
MATTEY



# 164

### PER / FOR

**SWEDA (I)**

+ PREFER (143)

+ PRIM (144)

**SWISSTAC (D)**

DOM (61)

**TACO (USA)**

SCHLAGE (151-152)

**TALLIN (EST)**

**TAMPALINI (I)**

BALLY

K+K

SAB

TF

+ MORI E. (128)

**TANLOCKS (RSA)**

LÄSBOLAGET (111)

**TARONI (I)**

PER: **SWEDA**

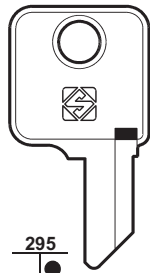

295

**SW3**

L



TALLIN

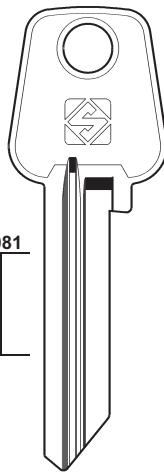

1081

**BLT1R**

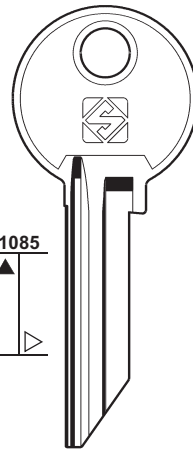

1085

**TLN1**

TAMPALINI

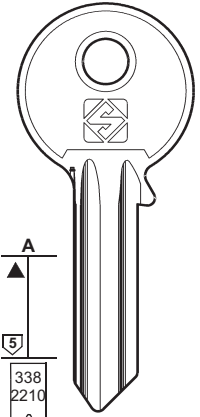

A

5

338

2210

**TP1**

**TP1R**

..... 123456

..... 12345

BALLY - K+K - SAB - TF

PER: **TAMPALINI**

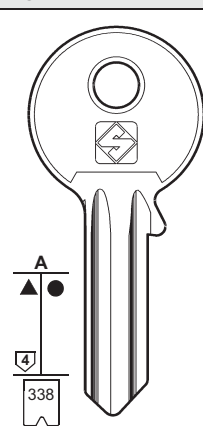

A

4

338

**TP2**

**TP2R**

..... 1-2-3-4-5-6

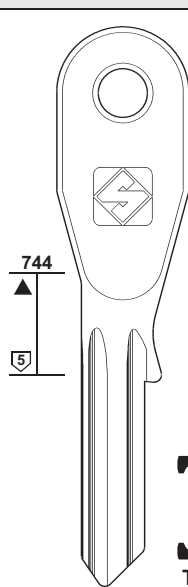

744

5

**TP3**

**TP3R**

TARONI

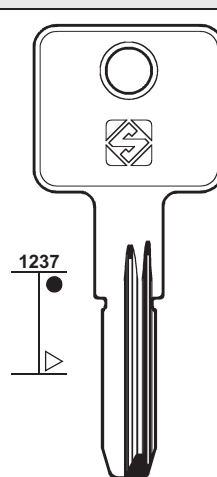

1237

5

**TAR21**

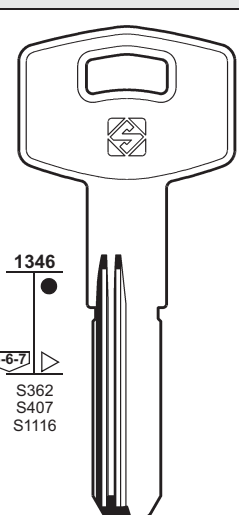

1346

5-6-7

S362

S407

S1116

**TAR16**



**TAR16R**

PER: **TARONI**

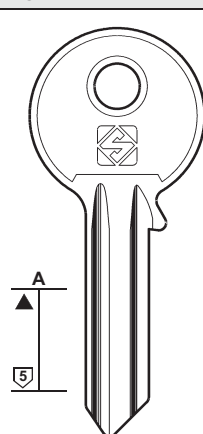

A

5

**TAR4**

**TAR4R**

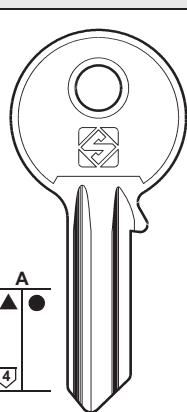

A

4

**TAR5**

**TAR5R**

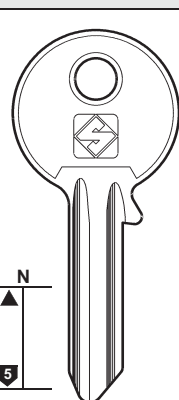

N

5

**TAR8**

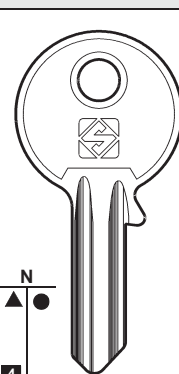

N

4

**TAR3**

**TAR3R**



74

4

**TAR1**

**TAR1R**

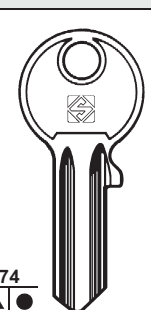

74

3

**TAR2**

**TAR2R**



PER: FOR:	TARZEN	TAS	TAYLOR	TECSESA
	<p>68</p> <p>5</p> <p>TZN1</p>	<p>161</p> <p>TUS1 TUS1R</p> <p>TUS2R</p> <p>BIBERING - TÜRSCHLOSS</p>	<p>707</p> <p>5</p> <p>TY1</p>	<p>1310</p> <p>TEC1</p>



# 165

PER / FOR  
**TARZEN** (RC)  
**TAS** (D)  
 BIBERING  
 TÜRSCHLOSS  
**TAUB** (E)  
 ZANETTI A. (200)

PER: FOR:	TEGASI	TEICOCIL	TEKA
	<p>106</p> <p>TGS1R</p>	<p>1241</p> <p>TCL1</p>	<p>162</p> <p>5</p> <p>350 588</p> <p>ASS6 ● ASS6R</p> <p>20201 20301</p> <p>..... 0-1-2-3-4-5-6-7-8-9-A-B-C</p> <p>..... D-0-1-2-3-4-5-6-7-8-9-A-B-C</p> <p>ASSA</p>

**TAV** (F)  
 RONIS (147)  
**TAYLOR** (USA)  
**TEC** (F)  
 STAR (161)  
**TECHNAL** (D)  
 CAS-CISMA (40)  
 TESA (165)  
**TECNOR** (F)  
 FICHET (80)  
**TECSESA** (E)  
**TEEN HAAF** (NL)  
 KIFERM (106)  
**TEGASI** (GR)  
**TEICOCIL** (P)  
**TEKA** (S)  
 ASSA  
 ERICSSON  
 ERMEX  
 LM  
 + ASSA (18)

PER: FOR:	TEKA	TESA
	<p>162</p> <p>5</p> <p>577</p> <p>ASSA ERMEX LM</p> <p>TK1 20004</p> <p>..... 0123456789ABCEFG</p> <p>TK1R 20102</p> <p>ASSA ERMEX LM</p> <p>TK2 21001</p> <p>TK3R 20802</p> <p>TK4R 21601</p> <p>TK4 21701</p> <p>TK2R 21101</p> <p>ERICSSON</p>	<p>369</p> <p>5</p> <p>770</p> <p>369</p> <p>5</p> <p>369 387 512 726 770</p> <p>TE3</p> <p>..... 123456789</p> <p>..... A/Z 123456789</p> <p>TE6</p> <p>..... 0987654321</p> <p>TE1 ▲ TE1R</p> <p>..... (TE-5)</p> <p>0-9-8-7-6-5-4-3-2-1</p> <p>TE2 ESAFE</p> <p>..... (TE-5) 0987654321</p> <p>..... 0123456789</p> <p>..... 123456789</p> <p>..... A/Z 123456789</p> <p>TE2R ▲</p> <p>..... 123456789</p> <p>..... A/Z 123456789</p> <p>GAINSBOROUGH        KAWE - METALUX        NINO - SOS - TECHNAL</p>

**TELFORD** (GB)  
 L & F (116)  
**TEM** (E)  
 IFAM (95)  
**TERCA** (E)  
 AGA (11)  
**TESA** (E)  
 ESAFE  
 GAINSBOROUGH  
 KAWE  
 METALUX  
 NINO  
 SOS  
 TECHNAL  
 + ELCA (68)



# 166

**PER / FOR****TESA (E)**KALE  
STS  
VIRO  
+ ELCA (68)**TESIO (I)**

CORBIN (53)

**TESTA (I)**

CAS-CISMA (40)

**TF (I)**

TAMPALINI (164)

**TH (D)**H.R.S.  
TRUMPF**THIRARD (F)****THÖMEE (I)**

CES (44)

**THÖNE (D)**

CORBIN (53)

**TICINO (I)**

BERTOLOTTI

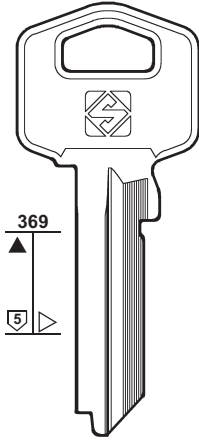
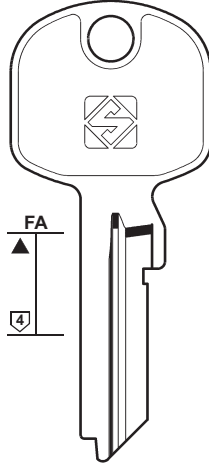
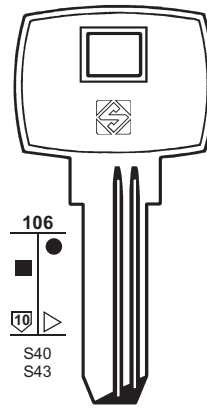
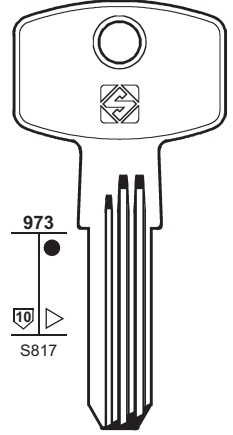
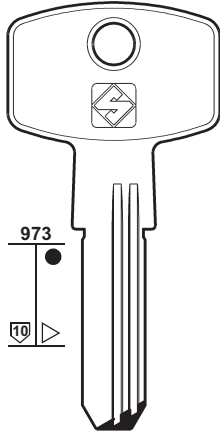
**TIEFENTHAL (D)** CISA (48)  
 ELZETT (68)  
 EMR (69)  
 GTV (90)  
 JOWIL (100)**TIFON (RC)**PER:  
FOR:**TESA****TE2X****TE8XFA****TE4**  
T-10**TE4R****STS****TE16**  
T-10PPER:  
FOR:**TESA****EC5**

KALE - STS - VIRO

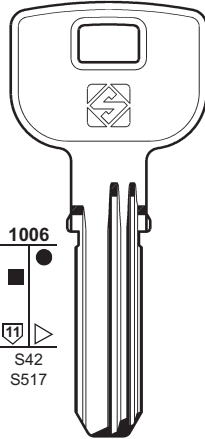
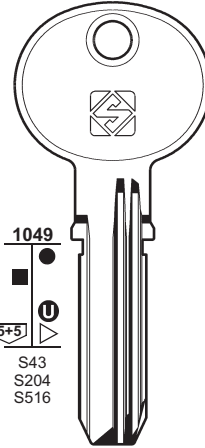
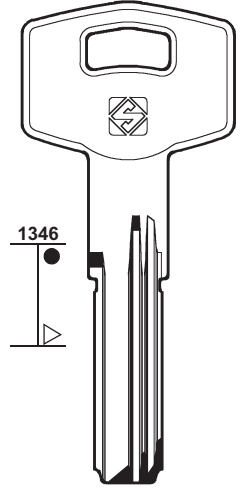
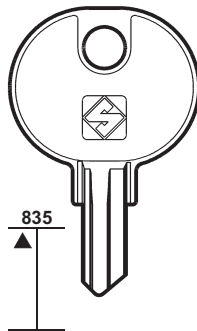
**TE5**  
T-80**TE9**  
T80/SC**STS****TE7**  
T-60**STS****TE19**PER:  
FOR:**TH****THA1**

H.R.S. - TRUMPF

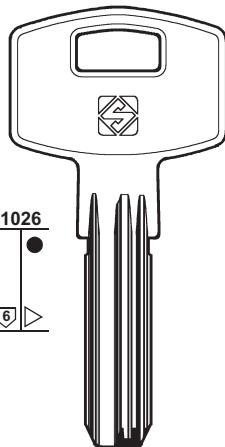
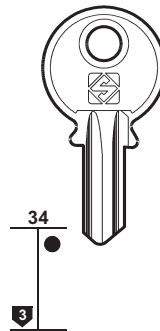
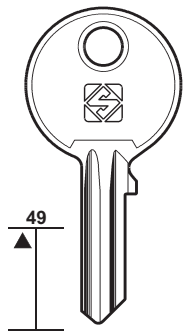
**THIRARD****THR1****TICINO****TC1****TC1R****BERTOLOTTI****TIFON****TFN1****TFN2**

PER: FOR:	TIGRIS	TIK	TITAN	



**167**

PER / FOR
TIGRIS (GB)
TIK (GB)
TITAN (SLO)
TITAN (SLO) EMKA GIUSSANI LAMA PICARDIE

PER:  
FOR:

**TITAN**

		... 123456789	

PICARDIE

PER:  
FOR:

**TITAN**



168

PER / FOR

TITAN (SLO)  
FTH  
VACHETTE

TITUS (GB)  
W.M.S. (192)

TM (D)  
DOM (61)

TOKOZ (CZ)

TOK-TRELOCK (D)

TOK-WINKHAUS (D)  
MASTER

PER:  
FOR:

### TITAN

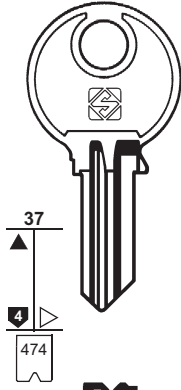

TN9  
... 251-300

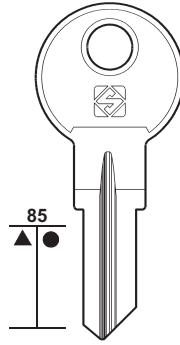

TN10

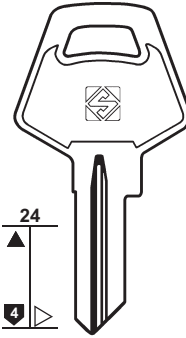

TN6R

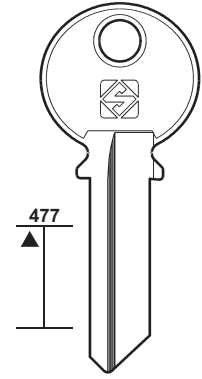

TN11R



TN14

FTH  
VACHETTE

PER:  
FOR:

### TITAN

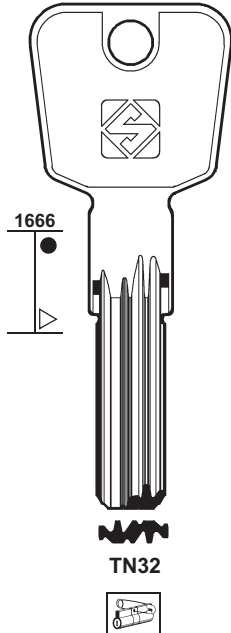

TN32

### TOKOZ

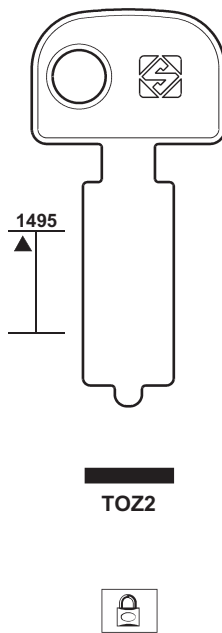

TO2

### TOK-TRELOCK

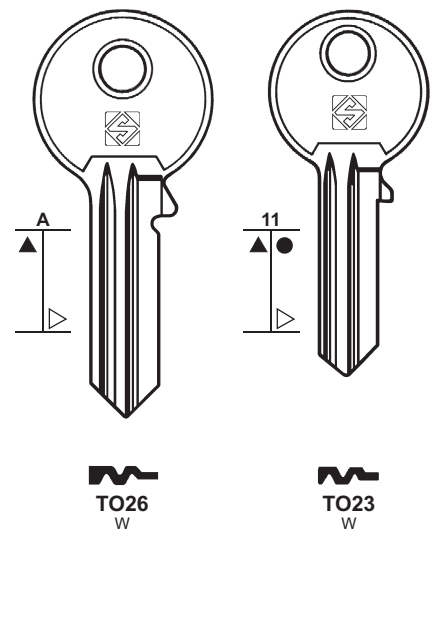

TO26  
W

TO23  
W

PER:  
FOR:

### TOK-TRELOCK

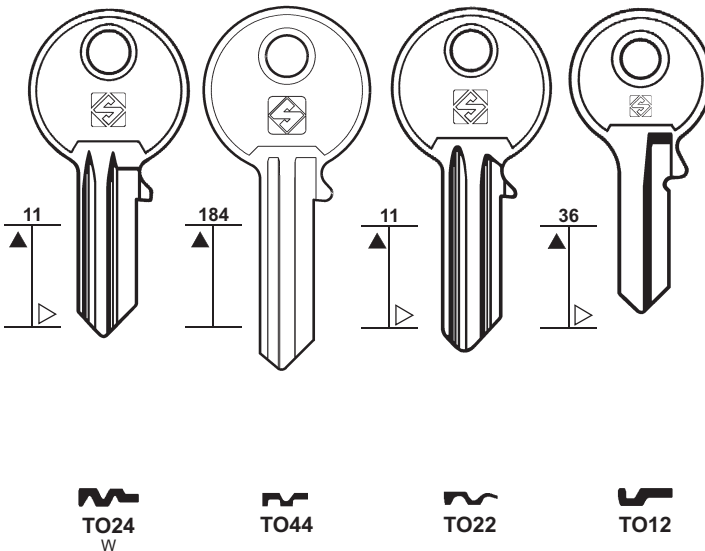

TO24  
W

TO44

TO22

TO12

### TOK-WINKHAUS

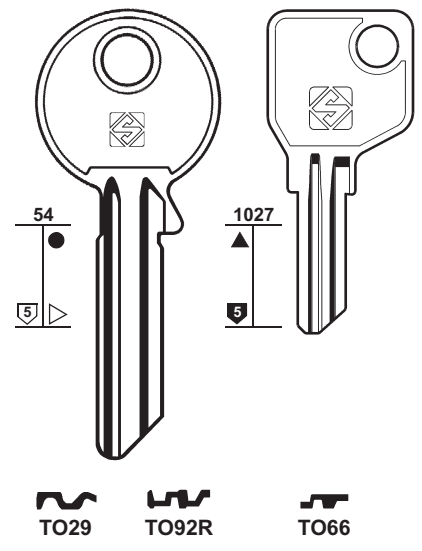

TO29

TO92R

TO66





PER:  
FOR:

### TOK-WINKHAUS

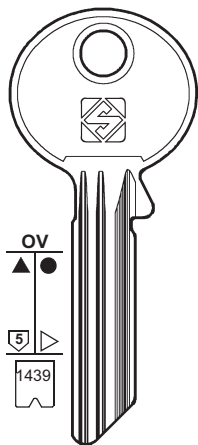

X.....  
0-1-2-3-4-5-6

	TO8X1		TO8RX1		TO8X7		TO8RX13
	TO8X2		TO8RX2		TO8X8		TO8RX14
	TO8X3		TO8RX3		TO8X9		TO8RX15
	TO8X4		TO8RX4		TO8X10		TO8RX16
	TO8X5		TO8RX5		TO8X11		TO8RX17
	TO8X6		TO8RX6		TO8X12		TO8RX18



# 169

PER / FOR

TOK-WINKHAUS (D)  
DISQUIN

PER:  
FOR:

### TOK-WINKHAUS

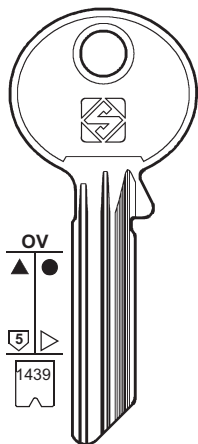

Y.....  
0-1-2-3-4-5-6

	TO9Y1		TO9RY1		TO9Y7		TO9RY13
	TO9Y2		TO9RY2		TO9Y8		TO9RY14
	TO9Y3		TO9RY3		TO9Y9		TO9RY15
	TO9Y4		TO9RY4		TO9Y10		TO9RY16
	TO9Y5		TO9RY5		TO9Y11		TO9RY17
	TO9Y6		TO9RY6		TO9Y12		TO9RY18

PER:  
FOR:

### TOK-WINKHAUS

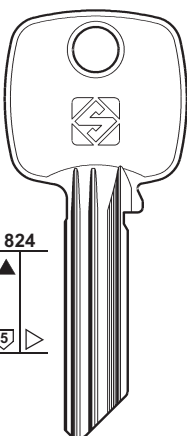

	TO50X1		TO50X9		TO50RX9
	TO50X2		TO50RX2		TO50X10
	TO50X3		TO50X11		
	TO50X4		TO50RX4		TO50X13
	TO50X5		TO50RX5		TO50X14
	TO50X6		TO50RX6		TO50X15
	TO50X7		TO50RX7		TO50X17
	TO50X8		TO50X18		

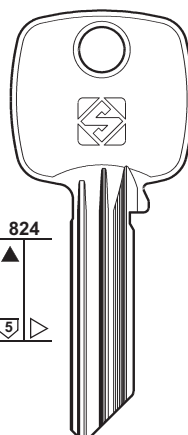

	TO51Y1		TO51RY1
	TO51Y2		TO51Y10
	TO51Y3		TO51Y11
	TO51Y5		TO51RY4
	TO51Y6		TO51RY6
	TO51Y7		TO51Y14
	TO51Y8		
	TO51Y9		



170

PER / FOR

TOK-WINKHAUS (D)  
COMBA  
EGSA  
SIEBAU  
TRELOCK  
VACHETTE

PER:  
FOR:

### TOK-WINKHAUS

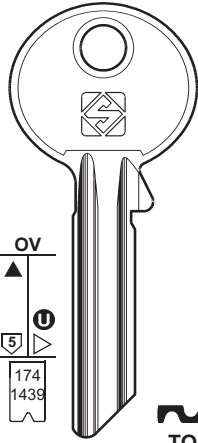

TO54-1	TO54-2	TO54-3	TO54-4
TO54-5	TO54-6	TO54-7	TO54-8
TO6 9	TO5 Z.....0123456	TO3 11	TO4 12
TO54-13	TO54-14	TO7 15	TO54-16
TO54-17	TO54-18	TO54-19	TO54-20
TO1	TO54-21	TO2 22	TO54-23
TO15	TO16	TO17 EGSA	TO75R
TO25R	TO28R	TO31R	TO82R

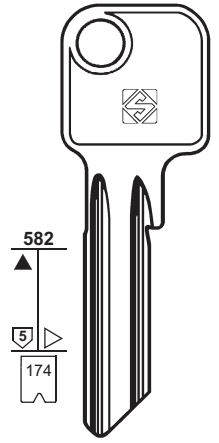
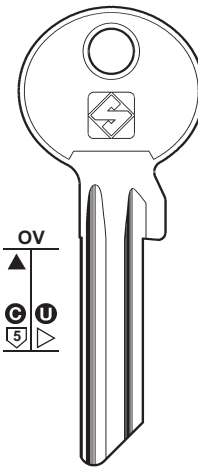

N/T/9 .....  
012345678  
N.....0123456  
.....9 012345678

COMBA - SIEBAU  
TRELOCK - VACHETTE

TO1X

TO10  
P.....  
0-1-2-3-4-5-6-7-8  
TRELOCK

PER:  
FOR:

### TOK-WINKHAUS

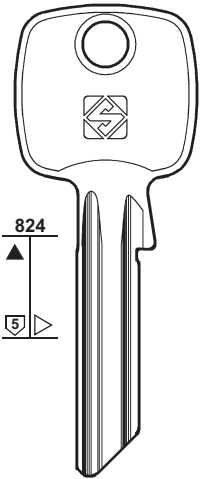
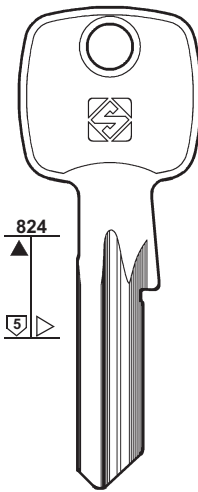
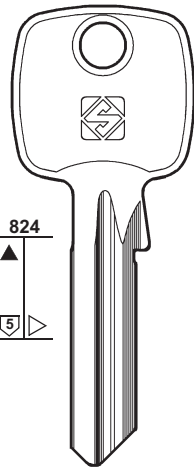
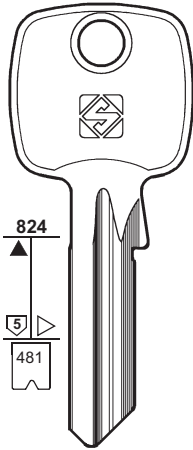
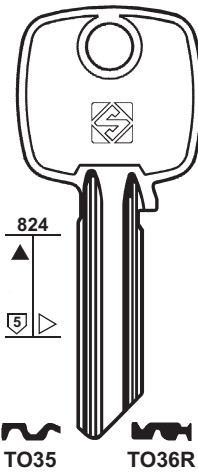

TO35  
TO36R

TO41R

TO114RX  
9.....X  
012345678

TO124RX

TO120RX

TO125X

PER:  
FOR:

### TOK-WINKHAUS

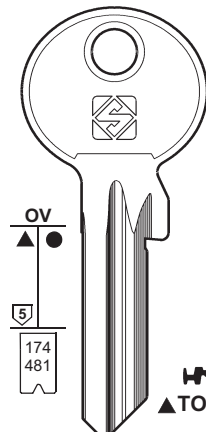
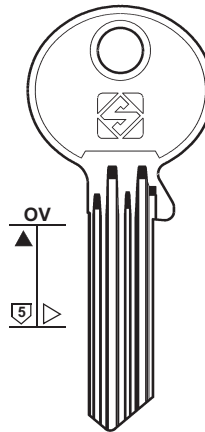
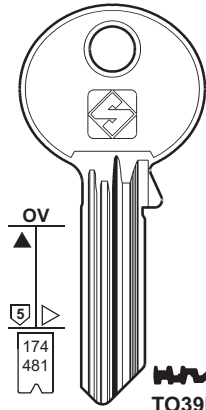
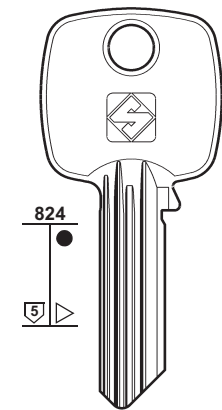

TO40  
TO42R

TO30  
9.....T  
012345678

TO30R  
9.....X  
012345678

TO34

TO81R

TO30X  
9.....T  
012345678

TO30RX  
9.....X  
012345678

PER:  
FOR:

# TOK-WINKHAUS

TO27▲●  
0123456789

TO18

TO19

TO20R

TO33

TO55 FAABF

TO57 EHBA EKCP

TO58 EFAM EFWS

TO59 EWSB

TO60 BFA2

TO61 BFA3

TO64 BYNY1

TO65

TO91

TO100

TO104

TO105

TO106

TO107

TO111R

TO127

471

TO11

TO13

TO14 EGSA

TO21

TO43

TO45■

TO52 ENAX

TO53 BFA1

TO105

471

1427  
2934

AZBE

AZBE

BIFFAR - FICHET



# 171

PER / FOR

**TOK-WINKHAUS (D)**  
AZBE  
BIFFAR  
EFAM  
EGSA  
ENAX  
FICHET

**TOP (D)**

ABUS  
NOVA  
+ 👁️ ABUS (6)  
+ 👁️ WILKA (191)

**TOR (I)**

👁️ ZANETTI A. (200)

**TORE (D)**

👁️ CES (42)

**TOUCH (GB)**

**TOVER (E)**

MASTER  
TROMER  
+ 👁️ FTH (81)

**TRABER (GB)**

👁️ EURO LOCKS (71)

PER:  
FOR:

## TOP

## TOUCH

10

OV

5

5

TOP1R

TOP1RX

ABUS - NOVA

47

47

47

7

5

7

3270

3270

3270

TOU1R

TOU2R

TOU3R

..... 12345

..... 12345

..... 12345

PER:  
FOR:

## TOVER

1213

1007

1007

1121

S49

S172

TV1

TV2

TV3

TV4

2F-35

2F-25

MASTER

TROMER



# 172

PER / FOR

**TRAINS** (RC)

**TRAU** (I)  
PREFER

**TRELOCK** (D)  
WASO

+ TOK-TRELOCK (168)  
+ TOK-WINKHAUS (170)

**TRI-CIRCLE** (RC)  
ABUS  
ELEPHANT

+ DOUBLE CIRCLE (67)

PER:  
FOR:

## TRAINS

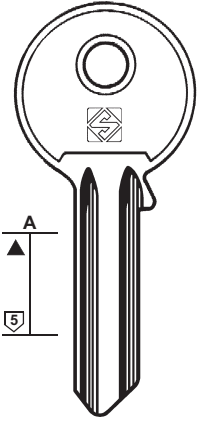

TS1

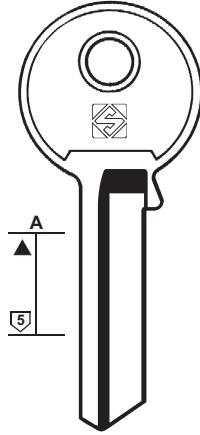

TS2

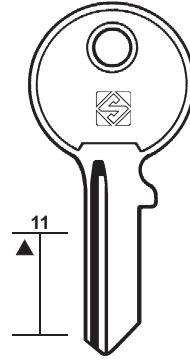

TS3

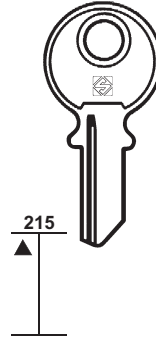

TS4

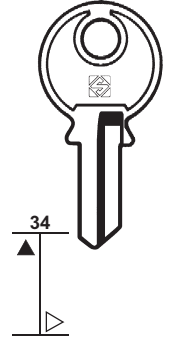

TS5



PER: **TRAU**  
FOR:

## TRELOCK

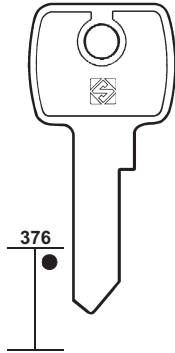

TRU1R

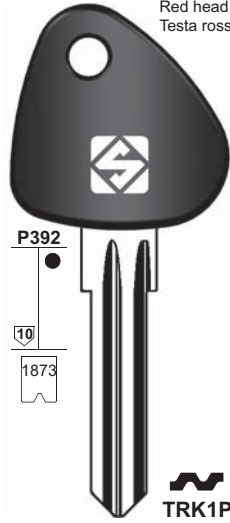

TRK1P

R6 .....  
0-1-2

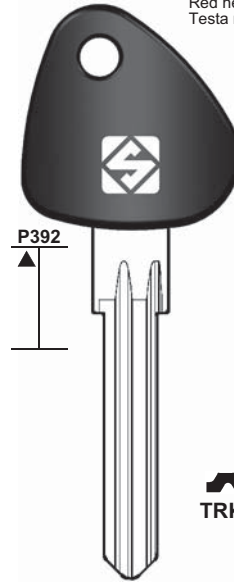

TRK7P

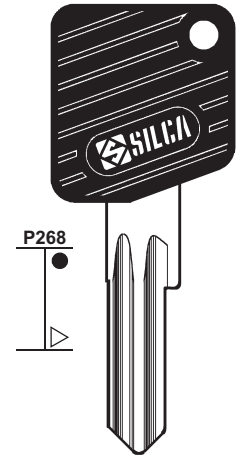
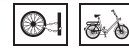
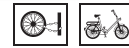

TRK4CP

WASO

PER:  
FOR:

## TRI-CIRCLE

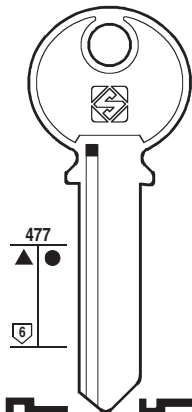

TL3 1C TL3R 1A

TL8 1D TL8R 1B

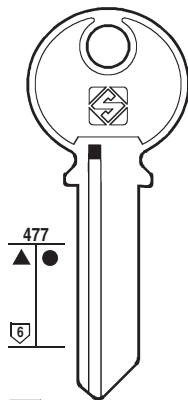

TL2 2D TL2R 2B

TL5 2C TL5R 2A

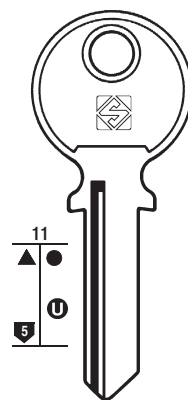

TL1 3C TL1R 3A

TL4 3D TL4R 3B

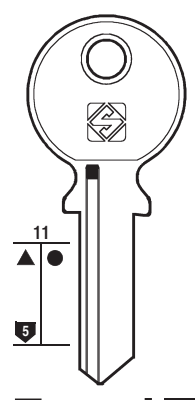

TL6 4C TL6R 4A

TL7 4D TL7R 4B



ABUS - ELEPHANT

PER:  
FOR:

### TRI-CIRCLE

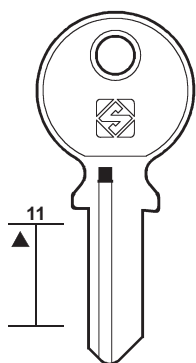

TL15

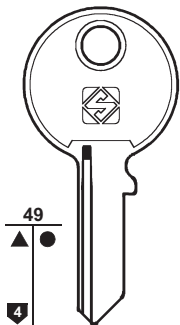

TL9  
5C  
YONGTAI

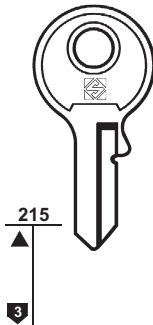

TL12R

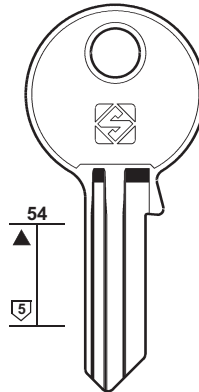

TL14

TL9R  
5A

TL10  
5D  
TL10R  
5B  
ABUS - MARK



# 173

PER / FOR

**TRI-CIRCLE (RC)**  
ABUS  
MARK  
YONGTAI  
+ DOUBLE CIRCLE (67)

**TRIO (N)**  
 TRIOVING (173)

**TRIOVING (N)**  
TRIO

PER:  
FOR:

### TRI-CIRCLE

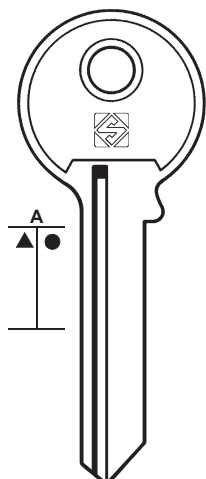

TL11 TL11R

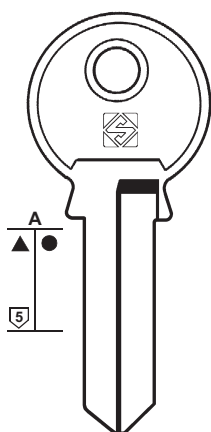

TL13



### TRIOVING

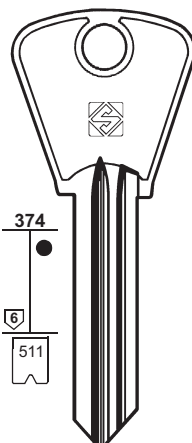

TR1

0-1-2-3-4-5-6-7-8-9-A

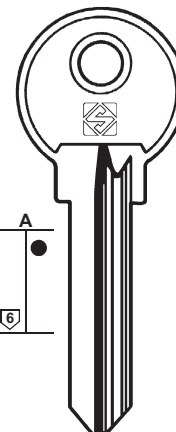

TR2

TRIO

PER:  
FOR:

### TRIOVING

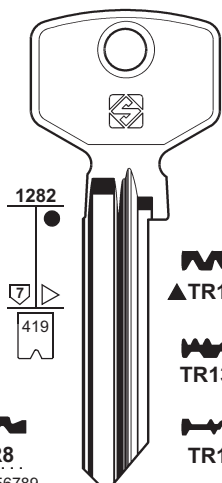

TR8  
0123456789

TR9

TR10

TR16

TR13R

TR12

TR11R

TR10R

TR19R

TR18R

TR17R

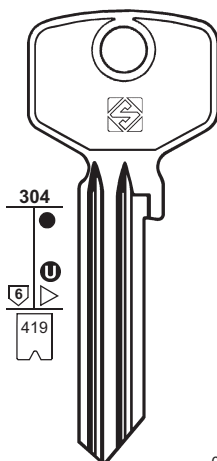

TR4

..... 0123456789  
..... NK 1-18342  
..... 1-26770  
..... 30000-56769  
..... ND 1-99999  
D ..... 1-13278  
DCN ..... -82660  
..... 1-13278  
..... 1-26770

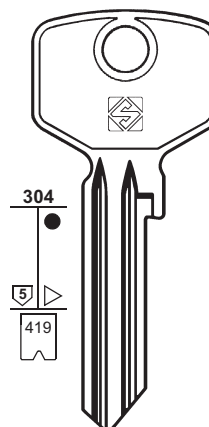

TR5

TR3

0-1-2-3-4-5-6-7-8-9



# 174

PER / FOR

**TRIOVING** (N)

**TRI STAR** (RC)

**TRITON** (D)

• CES (42)

• JOWIL (100)

**TROMER** (E)

• MCM (121)

• TOVER (171)

**TRUMPF** (D)

• TH (166)

**TRYBA** (A)

• EVVA (72)

**TULA** (RUS)

**TUSHINO** (RUS)

**TÜRSCHLOSS** (D)

• TAS (165)

**TWINLOCK** (GB)

**TWIRHONB** (F)

• ASIA (18)

**TZAFRER** (GR)

+ • CISA (48)

+ • GEGER (84)

**UAP** (GB)

PER:  
FOR:

## TRIOVING

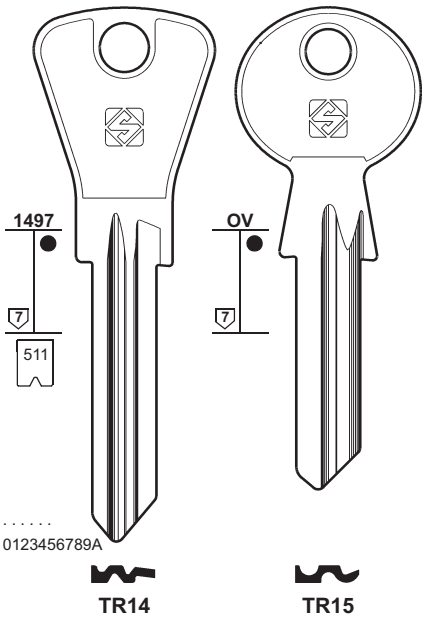

## TRI STAR

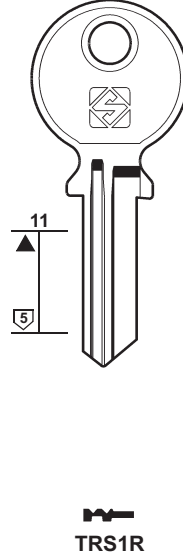

## TULA

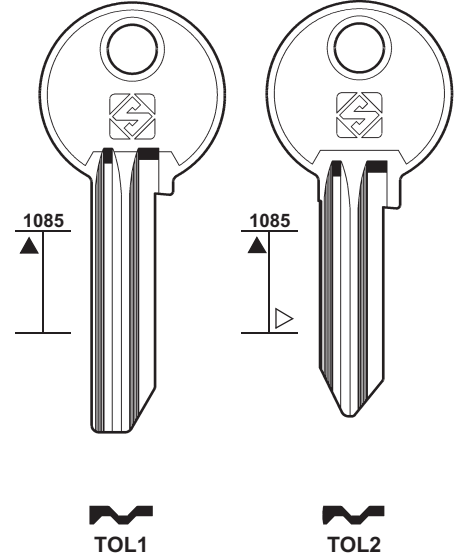

PER:  
FOR:

## TUSHINO

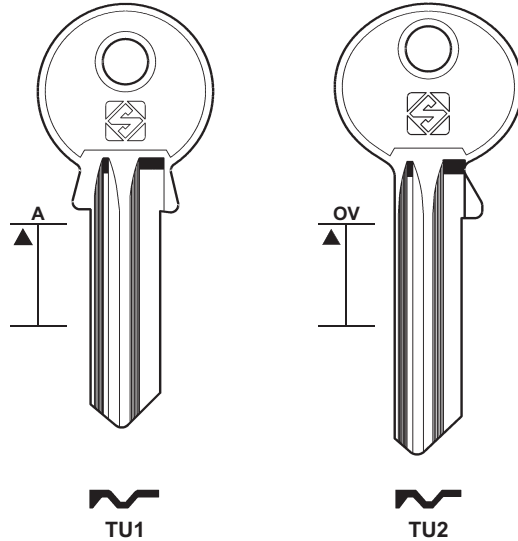

## TWINLOCK

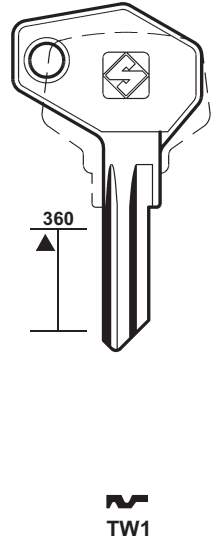

PER:  
FOR:

## TZAFRER

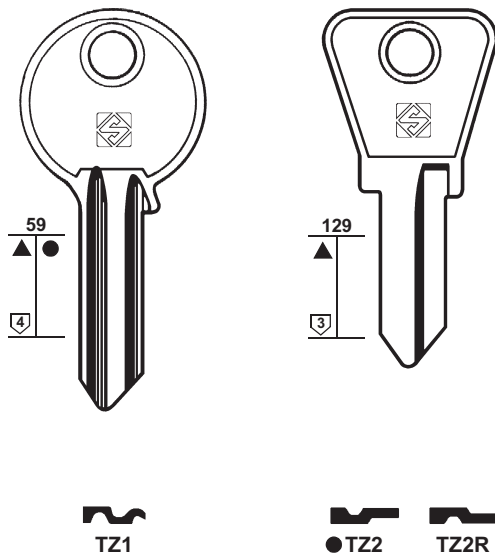

## UAP

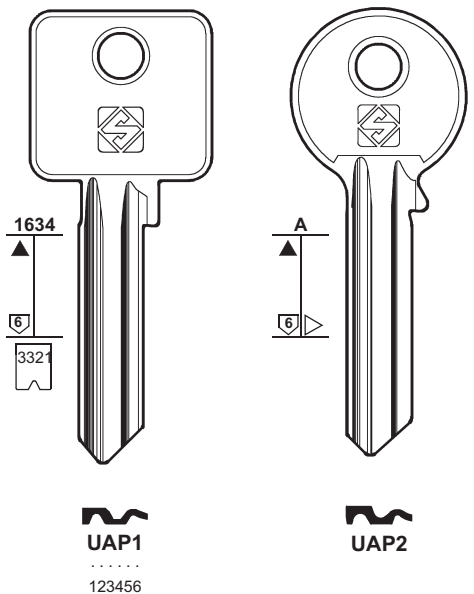

PER:  
FOR:

### UCEM

29  
811

1204

P244  
S170  
S196

1203  
S170  
S196

1203

UC2

UC1 UC1R

UC6R

UC3RP  
2000S

UC5R

UC4R

CIB - RIV

ESAFE - ISEO  
YEMAR



# 175

PER / FOR

**UCEM** (E)  
CIB  
ESAFE  
ISEO  
RIV  
YEMAR

**UEME** (BR)

**ULIANOVSK** (RUS)

**ULTRA** (GB)  
L & F (116)

**UMF** (P)  
+ YALE (193)

**UNIFERRO** (F)  
CISA (48)

**UNIFOR** (I)  
PREFER (142)

PER:  
FOR:

### UCEM

1386

UC8R

### UEME

1156

1156

1292

UE5R

UE4R

UE2R

PER:  
FOR:

### UEME

1292

UE3R

### ULIANOVSK

1088

ULS1R

### UMF

54

A

UM1

UM2



176

PER / FOR

UNION (GB)  
HENDERSON  
ONIUN

PER:  
FOR:

UNION

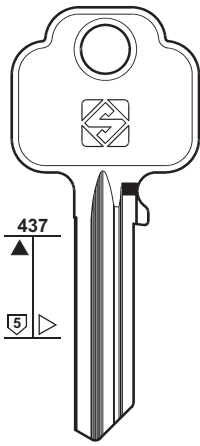

UNI66R B-MLA  
UNI68R NE

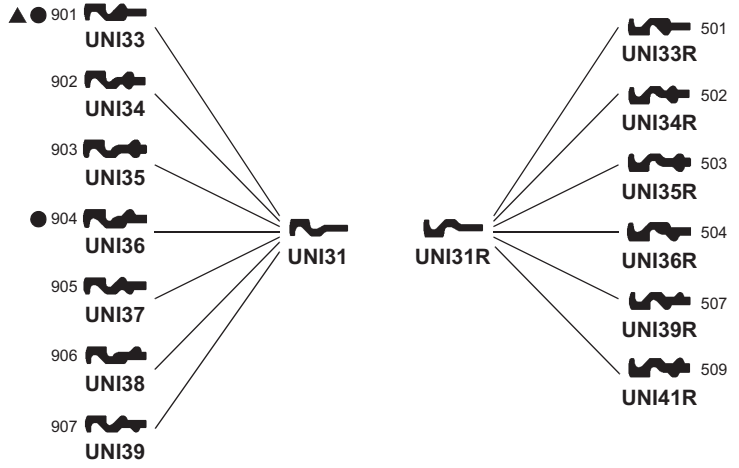

PER:  
FOR:

UNION

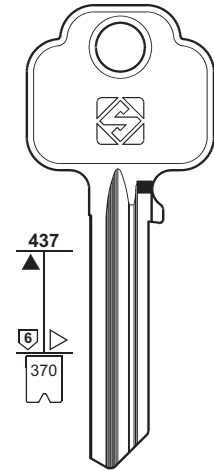

UNI67R B-MLA

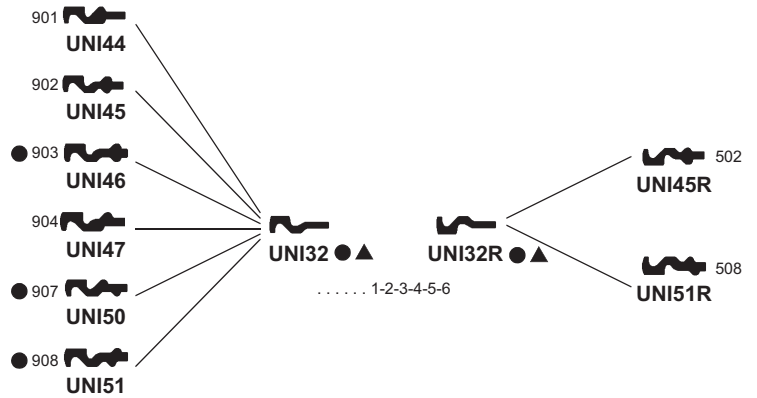

PER:  
FOR:

UNION

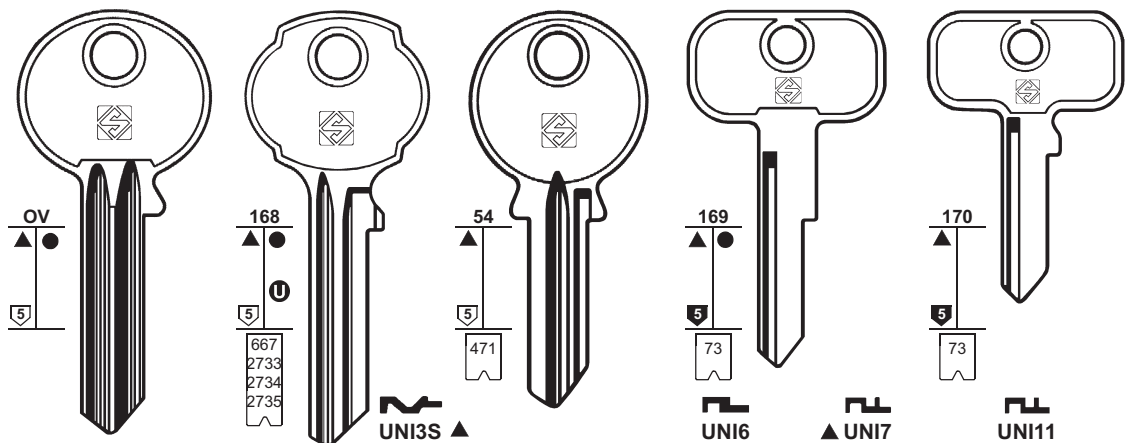

UNI28 KB506  
UNI3 KB502  
UNI3S  
UNI54R ZA1  
UNI18 NJ  
UNI6  
UNI16  
UNI17  
UNI16R  
UNI11  
UNI14

ONIUN



PER:  
FOR:

# UNION

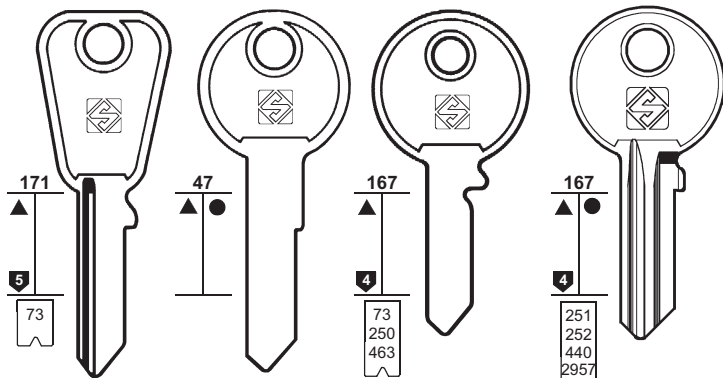

NKL ... 151-300  
NND ... 151-300  
TBS ... 201-350



NKW/A ... 1001-1100  
NKW/A ... 1-100  
NKW/X ... 1-100  
NKW/H ... 1-50  
NKL ... 301-450  
NND ... 1-150  
NND ... 301-450  
NPK ... 1-100



TBS ... 1-100  
NKL ... 1-150  
NND ... 1-150  
TBS ... 1-50  
TBS ... 101-200  
TBS ... 201-300  
TBS ... 201-350  
TBS ... 301-400  
TBS ... 401-500



UNI61R  
TBS ... 201-350  
RV ... 1-450



UNI57R  
NKW/X ... 101-200  
NKW/A ... 101-200  
NKW/A ... 1101-1200

UNI12  
FP ... 626-750

UNI29  
KB682

UNI4  
NRA

UNI4R  
EJR ... 1-75

UNI27  
KB53A

UNI15  
... 1-99  
FS ... 1-99  
FS ... 876-955

FFE ... 1-100  
FL ... 251-500  
NRA ... 51-90  
FG ... 1-30  
NF ... 1-30  
EJR ... 1-75  
FMO ... 1-75

UNI5  
NGN ... 1-54

UNI63



# 177

PER / FOR

UNION (GB)

UNIVERSAL

PER:  
FOR: UNION

## UNIVERSAL SERIE DISTINZIONE

HEAD TYPE / TESTA TIPO N

HEAD TYPE / TESTA TIPO A

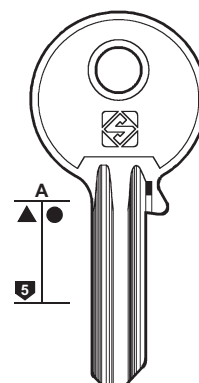
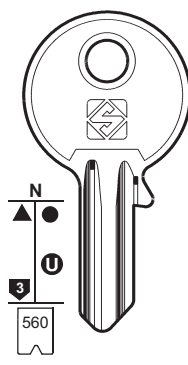
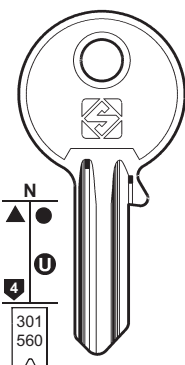
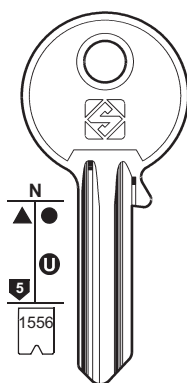
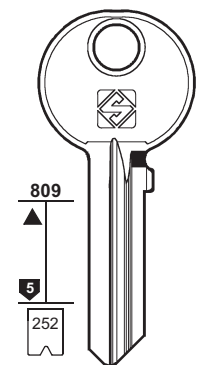

UNI60R  
NKW/X ... 201-300  
NKW/A ... 201-300

UL059

UL061

UL057▲●

UL059A

PER:  
FOR:

## UNIVERSAL SERIE DISTINZIONE

HEAD TYPE / TESTA TIPO A

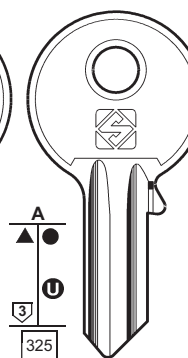
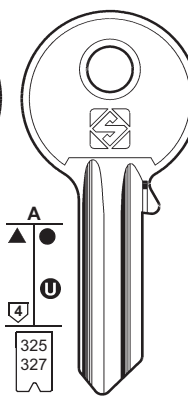
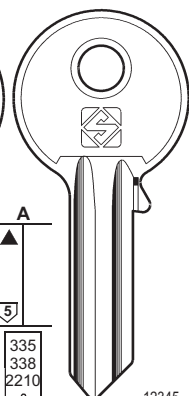
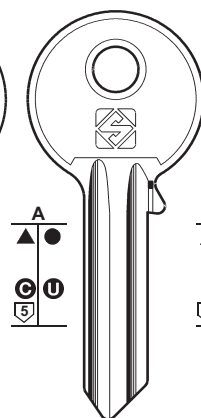
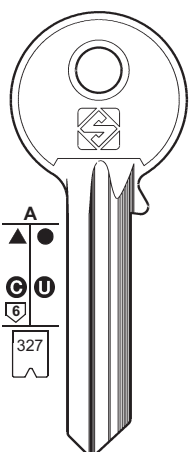
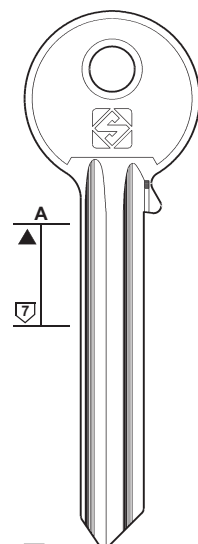

UL054 ... 123456

UL050

UL062

UL052 ... 0123456789  
... 123456

UL048

UL046

UL047

UL055

UL051

UL062

UL053 ... 123456

UL049



178

PER / FOR  
UNIVERSAL

PER:  
FOR:

### UNIVERSAL SERIE DISTINZIONE

HEAD TYPE / TESTA TIPO **B**

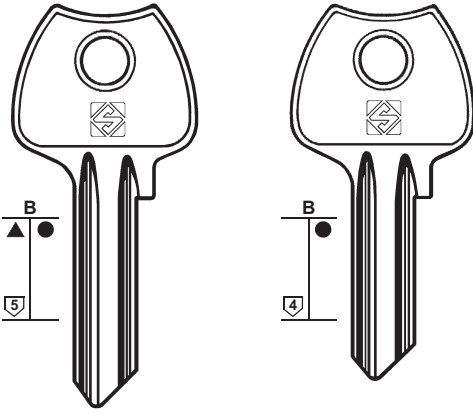

UL050B

UL052B

UL051B

UL053B

HEAD TYPE / TESTA TIPO **C**

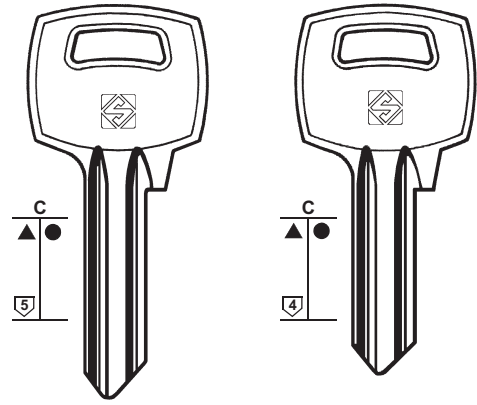

UL050C

UL052C

UL051C

UL053C

PER:  
FOR:

### UNIVERSAL SERIE DISTINZIONE

HEAD TYPE / TESTA TIPO **D**

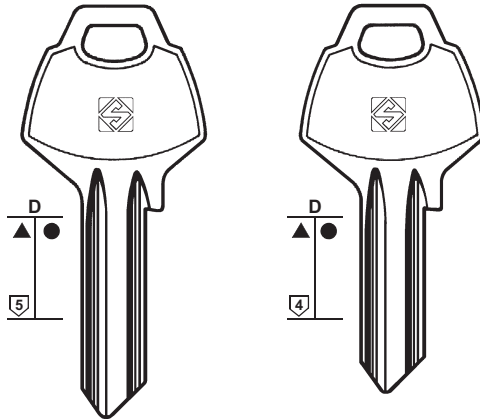

UL050D

UL052D

UL051D

UL053D

HEAD TYPE / TESTA TIPO **E**

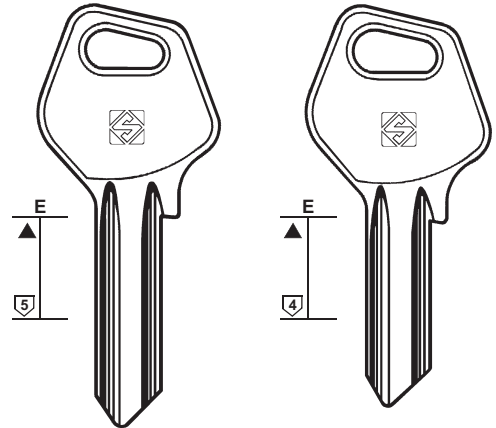

●UL050E

●UL052E

UL051E

UL053E

PER:  
FOR:

### UNIVERSAL SERIE DISTINZIONE

HEAD TYPE / TESTA TIPO **F**

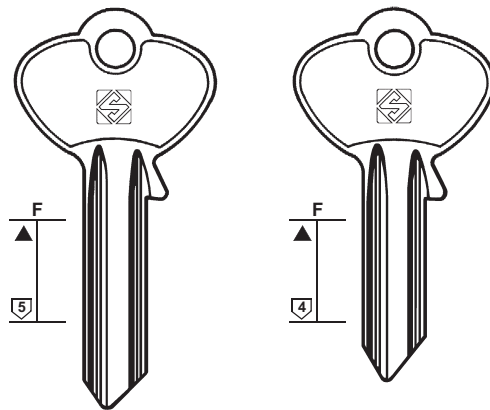

UL050F

UL052F

UL051F

HEAD TYPE / TESTA TIPO **G**

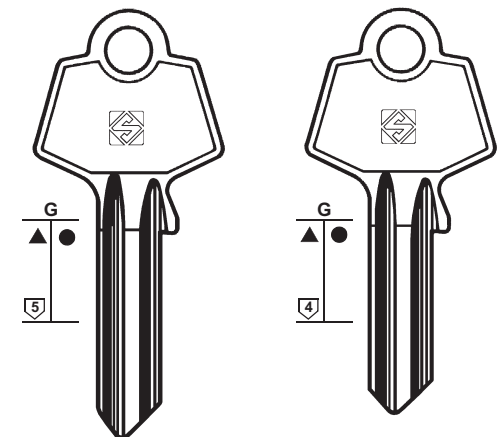

UL050G

UL052G

UL051G

UL053G

PER:  
FOR:

# UNIVERSAL SERIE DISTINZIONE

HEAD TYPE / TESTA TIPO **H**

HEAD TYPE / TESTA TIPO **L**

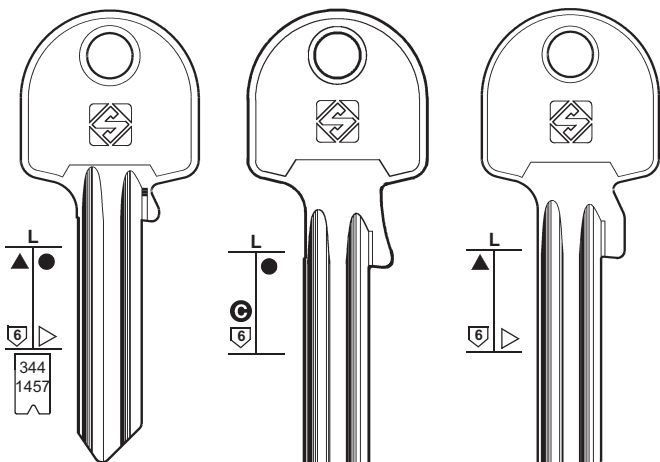
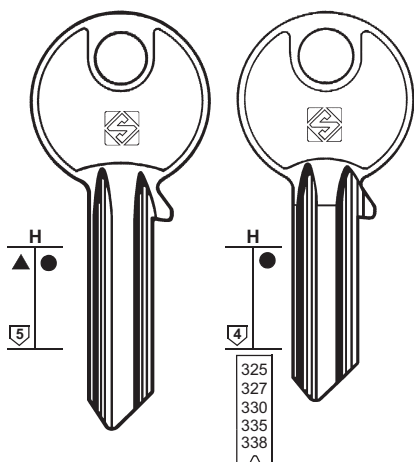

UL050H

UL052H

UL054L

UL054SL

UL054XL

..... 012345678  
 ..... 0123456789  
 ..... 12345  
 ..... 123456

..... 344  
 ..... 1457  
 ● UL055L ..... 12345678  
 ..... 123456789

UL055SL

UL055XL



# 179

PER / FOR  
UNIVERSAL

PER:  
FOR:

# UNIVERSAL SERIE DISTINZIONE

HEAD TYPE / TESTA TIPO **L**

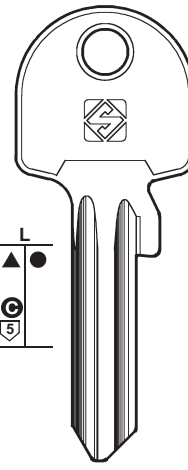
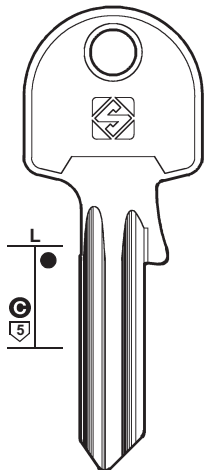
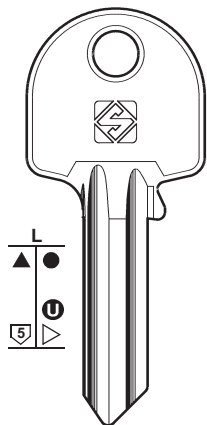

UL050L

UL050SL

UL050XL

● UL051L

UL051SL

● UL051XL

PER:  
FOR:

# UNIVERSAL SERIE DISTINZIONE

HEAD TYPE / TESTA TIPO **L**

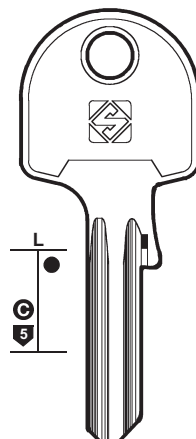
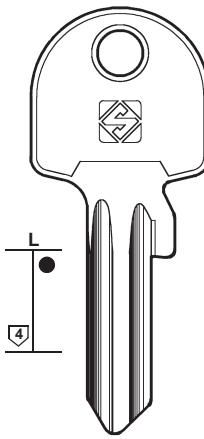
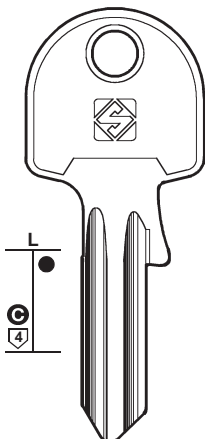
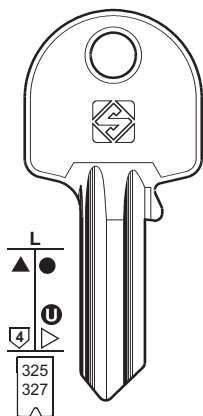

UL052L ..... 0123456789  
 ..... 123456

UL052SL

UL052XL

UL058SL

▲ ● UL053L ..... 123456

UL053SL



# 180

PER / FOR

**UNIVERSAL**

U.P.R. (D)

URBIS (R)  
BSS  
YALE

URKO (E)

UTZ (CH)

👁️ FORT (81)  
👁️ L & F (116)  
👁️ SIS (156)

VACHETTE (F)

ISEO  
KILT  
SANPEUR  
+ 👁️ ISEO (98)  
+ 👁️ KWIKSET (108)  
+ 👁️ TITAN (168)  
+ 👁️ TOK-WINKHAUS (170)  
+ 👁️ VEGA (185)

PER:  
FOR:

## UNIVERSAL SERIE DISTINZIONE

HEAD TYPE / TESTA TIPO **M**

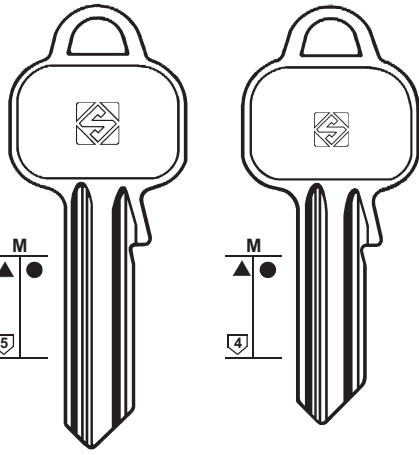

UL050M

UL052M

UL051M

UL053M

HEAD TYPE / TESTA TIPO **OV**

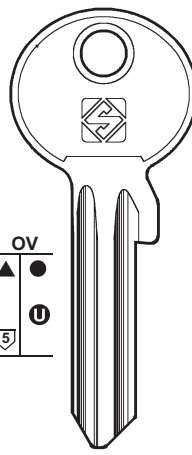

UL050X

UL051X

HEAD TYPE / TESTA TIPO **Y**

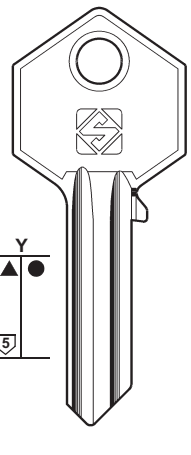

UL050Y

UL051Y

PER:  
FOR:

**U.P.R.**

**URBIS**

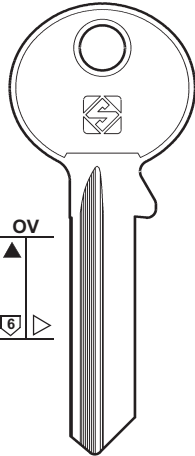

UP1

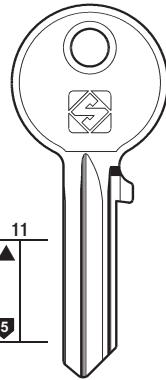

UB1R

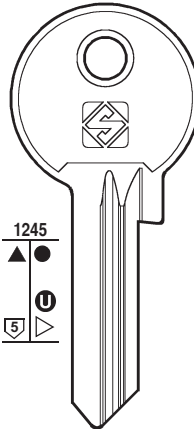

UB2R

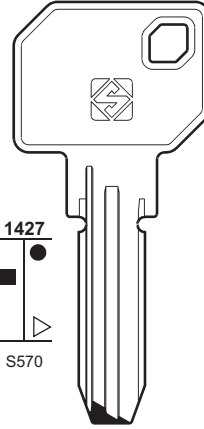

UB3

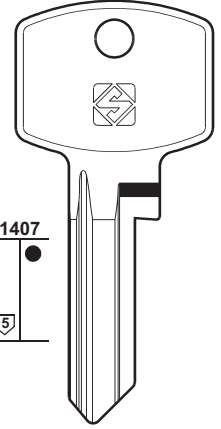

UB5

YALE



BSS - YALE

PER:  
FOR:

**URKO**

**VACHETTE**

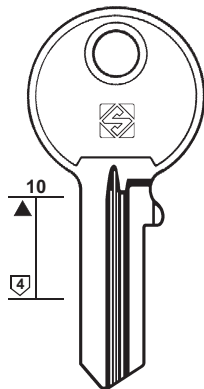

UR1

UR1R

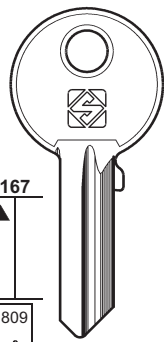

UR2

UR2R

1-2-3-4-5-6

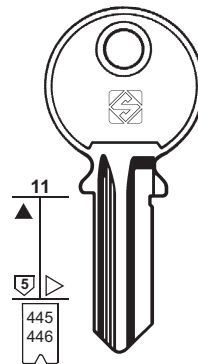

VAC46

..... 1-2-3-4-5-6-7-8  
B..... 1-2-3-4-5-6-7-8  
..... E 1-2-3-4-5-6-7-8-9-0



mm 40-50-60

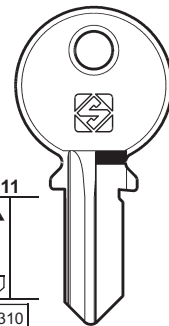

VAC1

VAC1R

E..... 9001-9100  
..... E 300-499  
..... R 9001-9100  
..... 1-2-3-4-5-6-7-8-9-0  
..... 1-2-3-4-5-6-7-8-9-0  
..... E 1-2-3-4-5-6-7-8-9-0



mm 30  
ISEO - KILT

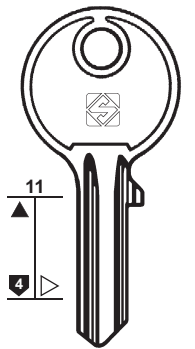

VAC8

VAC8R



SANPEUR

PER:  
FOR:

## VACHETTE

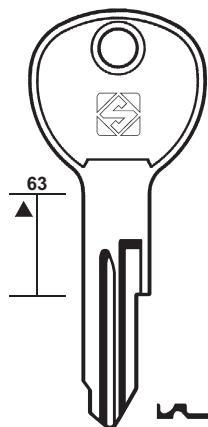

VAC44R



VAC100 VAC100R

VINCO

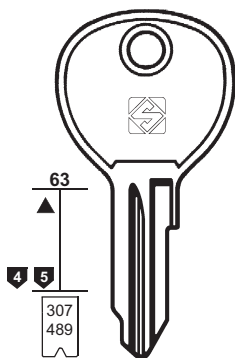

VAC25 VAC25R  
R... 0-423 G... 0-423  
D... 0-321



VAC33 VAC33R  
V... 0-423 W... 0-423

ATAL - VINCO

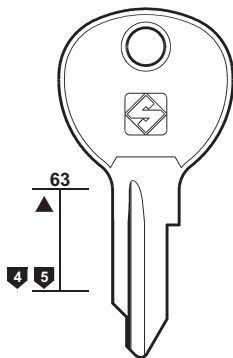

VAC106 VAC106R  
RS GS



VAC107 VAC107R  
VS WS

ATAL - VINCO

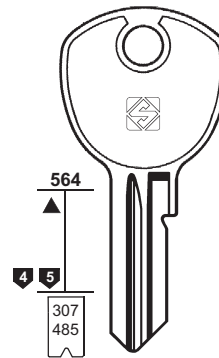

VAC65 VAC65R  
R... 0-423 G... 0-423  
G... 600-644 R... 600-644



VAC66 VAC66R  
V... 0-423 W... 0-423  
V... 600-644 W... 600-644

ATAL - VINCO



# 181

PER / FOR

### VACHETTE (F)

ATAL  
DAD  
FONTAINE  
HEMA  
JU  
METALUX  
MODERN BAU  
RUKA  
RONIS  
VINCO

- + ISEO (98)
- + KWIKSET (108)
- + TITAN (168)
- + TOK-WINKHAUS (170)
- + VEGA (185)

PER:  
FOR:

## VACHETTE

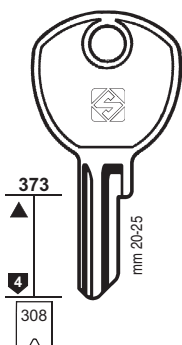

VAC42 VAC42R  
BL... (G) A0-H9 RL... A0-H9  
K... A0-H9 LR... (G) 0-49  
LB... 0-49 LG... 0-49

VAC60 VAC60R  
VL... (V) A0-H9 WL... (W) A0-H9  
LV... 0-49 LW... 0-49



DAD - JU

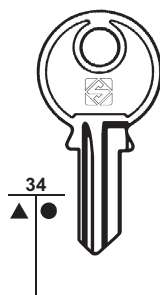

VAC11



RUKA

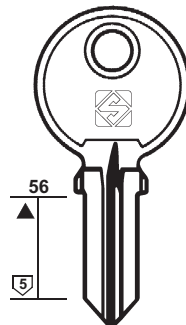

VAC10

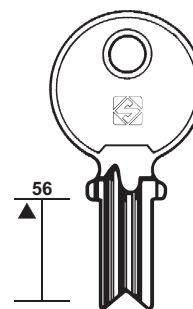

VAC41

PER:  
FOR:

## VACHETTE

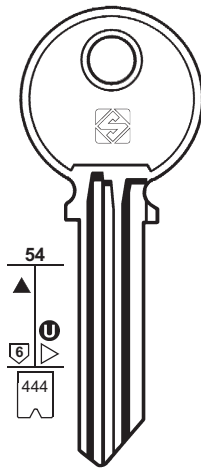

RO41

... 1-1296  
... 1-2-3-4-5-6-7-8-9-0  
V20... 1-1296  
A/Z 1-2-3-4-5-6-7-8-9-0



DAD - RONIS

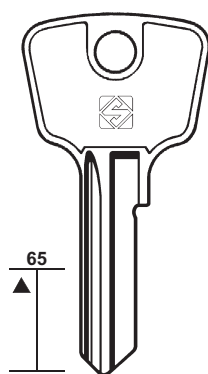

VAC14



mm 40-50-60

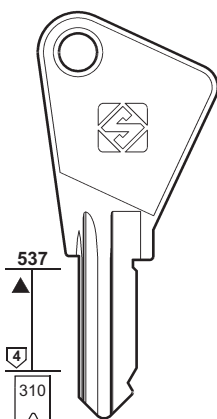

VAC61

EE... 9001-9100  
E... 2-3-4-5-6

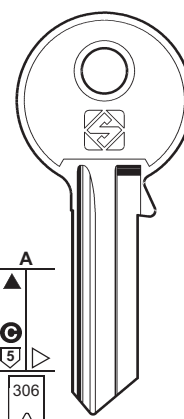

VAC29

A1... 5001-5631

FONTAINE - HEMA  
METALUX - MODERN BAU



# 182

### PER / FOR

#### VACHETTE (F)

- + ISEO (98)
- + KWIKSET (108)
- + TITAN (168)
- + TOK-WINKHAUS (170)
- + VEGA (185)

PER:  
FOR:

## VACHETTE

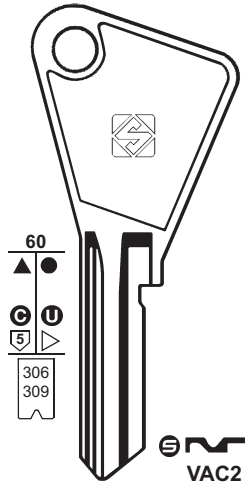

VAC2

- A1 ... 5001-5631
- UL ... 1-3500
- U ... 1-2-3-4-5-6-7-8-9-0
- U0 ... 1-9999
- UA ... 0001-1252
- UB ... 0001-5002
- UA ... 0830-6334
- LA ... 0000-6334

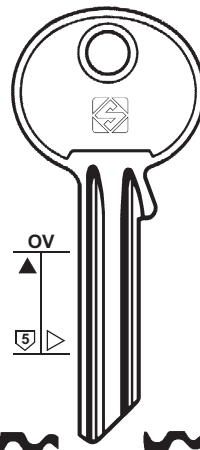

VAC30

VAC30R

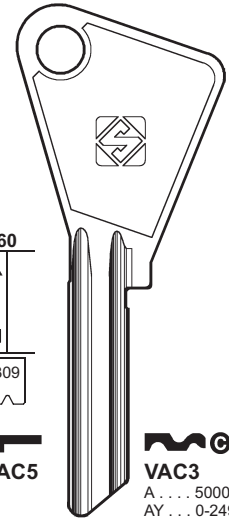

VAC5

VAC3

- A ... 5000-5635
- AY ... 0-249
- Y ... 0-249
- AS ... 0-099
- S ... 0-099
- A ... 2000-2999
- A ... 3000-3199
- AA ... 0000-1999



PER:  
FOR:

## VACHETTE

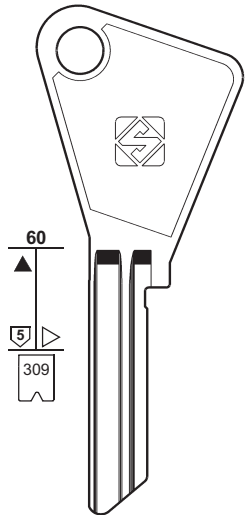

VAC56

AM ... 870-894

VAC47

BM ... 870-894

VAC57

CM ... 870-894

VAC58

DM ... 870-894

VAC63

- AM ... 870-894
- BM ... 870-894
- CM ... 870-894
- DM ... 870-894

VAC4

- AY ... 0-249
- Y ... 0-249

PER:  
FOR:

## VACHETTE

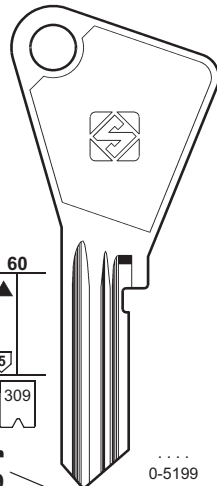

VAC19

VAC20

VAC21

VAC22

LHK

VAC21

LGK

LA-AK

VAC15

LB-BK

VAC16

LC-CK

VAC17

LE-EK

VAC19N

LF-FK

VAC20N

LG-GK

VAC21N

LJ-JK

VAC34R

LK-KK

VAC40

LL-LK

VAC31R

LD

VAC18

LDH

VAC23

LH

VAC22N

LDM

VAC37

LN

VAC6

LM

VAC36

LHM

VAC38

PER:  
FOR:

# VACHETTE



# 183

PER / FOR

- VACHETTE (F)**  
 + ISEO (98)  
 + KWIKSET (108)  
 + TITAN (168)  
 + TOK-WINKHAUS (170)  
 + VEGA (185)

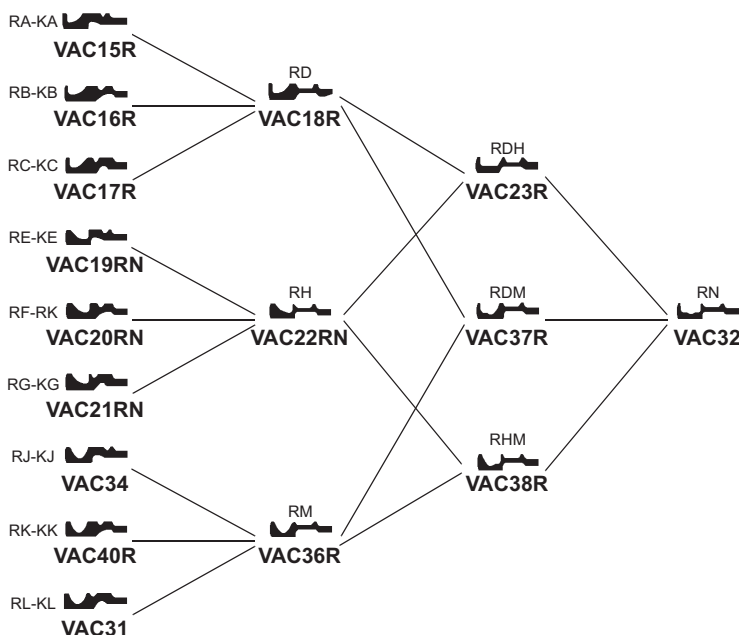
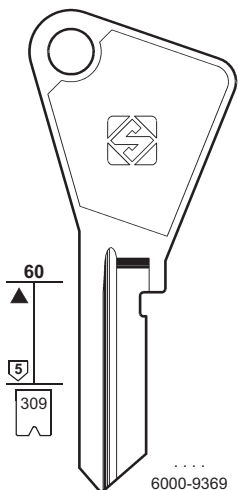

PER:  
FOR:

# VACHETTE

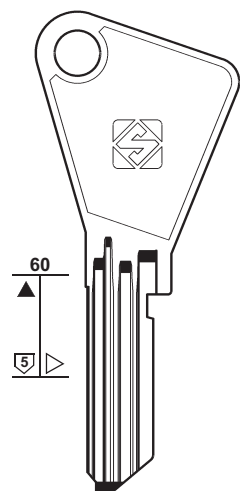

VAC101 KM235	VAC108 K200	VAC109 L202	VAC110 L226	VAC111 L229	VAC112 L230	VAC113 L240
VAC114 KL229	VAC115 K247	VAC116 KM236	VAC117 M258	VAC118 L225	VAC119 L243	VAC120 K023
VAC121 K024	VAC122 K025	VAC123 K234	VAC124 K235	VAC125 K236	VAC126 K237	VAC127 K238
VAC128 K239	VAC129 K240	VAC130 K242	VAC131 K243	VAC132 K244	VAC133 K245	VAC134 P294
VAC135 L019	VAC136 L020	VAC137 L021	VAC138 L022	VAC139 L223	VAC140 L224	VAC141 L227
VAC142 L228	VAC143 L239	VAC144 L244	VAC145 L245	VAC146 L246	VAC147 K020	VAC148 K021



184

PER / FOR

VACHETTE (F)

- AZMA
- CAP
- LAPERCHE
- + ISEO (98)
- + KWIKSET (108)
- + TITAN (168)
- + TOK-WINKHAUS (170)
- + VEGA (185)

VADETO (D)

- BLASER (32)

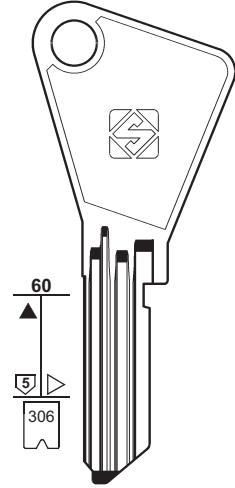

PER:  
FOR:

VACHETTE

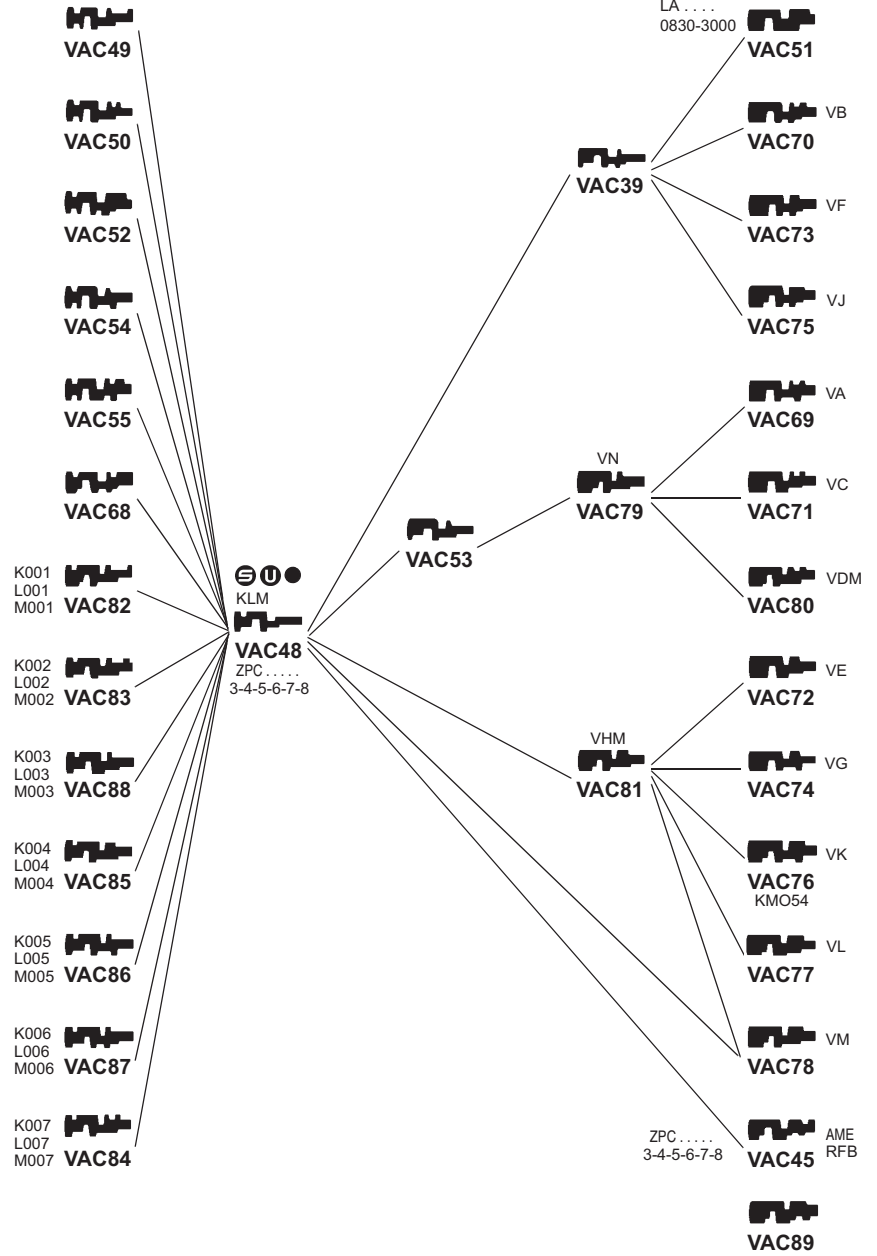

AZMA - CAP

PER:  
FOR:

VACHETTE

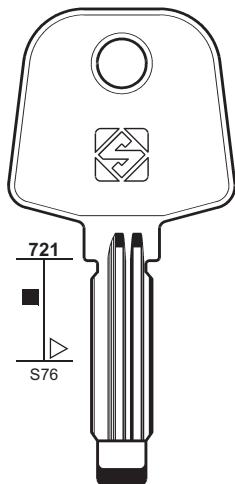

VAC91 VAC103

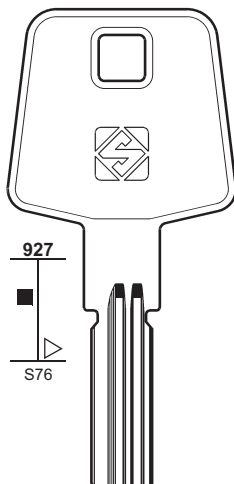

VAC104 VAC105

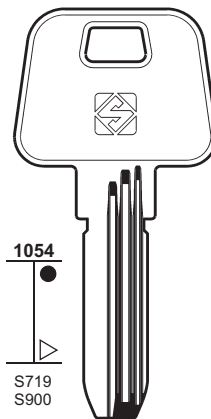

VAC150  
V6

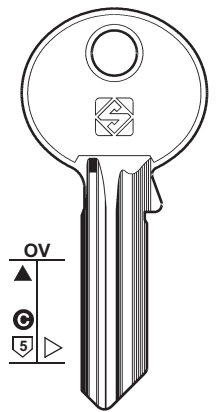

VAC151



LAPERCHE



PER: FOR:	VALE	VANGUARD	VARIOS
	VAL1	VGD1	VAR1
	VAL2		VAR1R

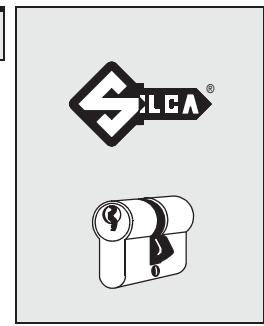

# 185

PER / FOR
VALE (RC)
VANGUARD (RA)
VARIO (D) 👁️ DOM (62)
VARIOS (E)
VASAR (RUS)
VAUGHN (GB) 👁️ HTV (93)
VBH (D) + 👁️ FCV (78) + 👁️ WILKA (191)
VDO (D) 👁️ KIENZLE (106)
VECO (E)
VEGA (F) VACHETTE + 👁️ ANTAR (17) + 👁️ RONIS (146)
VELO (RC) 👁️ YETI (198-199)
VENLOCK (YV) 👁️ WILSON BOHANNON (192)
VERA (CO) + 👁️ SATURN (151)
VERSCO (D) 👁️ CORBIN (53)

PER: FOR:	VARIOS	VASAR
	VAR5	VSR1R
	VAR2	VSR2
	VAR2R	VSR2R
	VAR3	
	VAR3R	
	VAR4	
	VAR4R	

PER: FOR:	VBH	VECO	VEGA	VERA
	VBH1R	VC1	VEG1	VR1
			VACHETTE	



# 186

PER / FOR

**V.G.F. VILLATORE (I)**

+ P.C. CORTELLEZZI (140)

**VIDMAR (CH)**

+ SEA (152)

**VIKI (D)**

+ DOM (62)

**VINCO (D)**

KARDEX  
+ VACHETTE (181)

**VING (N)**

NOBO

**VIOMETAL (F)**

+ EURO LOCKS (71)

**VIP (F)**

+ CITY (51)

**VIRO (I)**

FEB

KÖNIG

+ ABLOY (4)

+ ELCA (68)

+ FAI (76)

+ TESA (166)

PER:  
FOR:

## V.G.F. VILLATORE

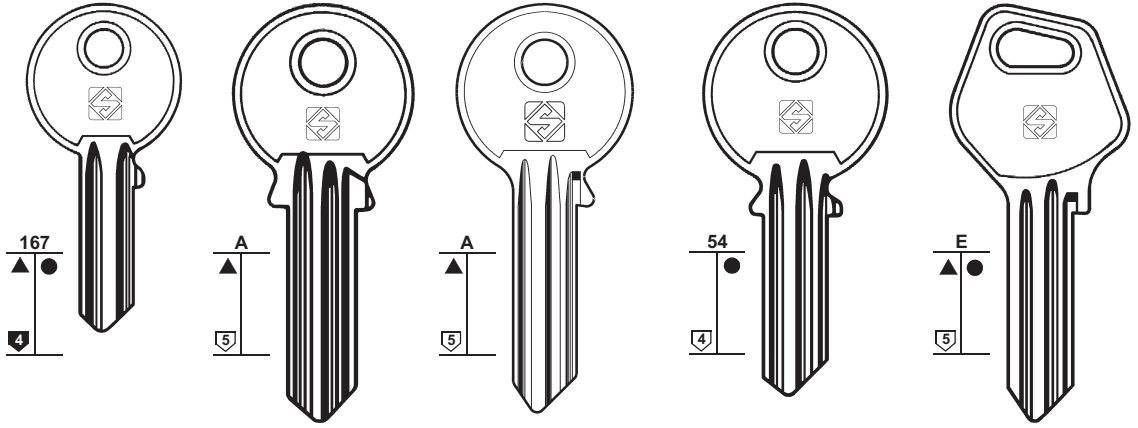

PER:  
FOR:

## VINCO

## VING

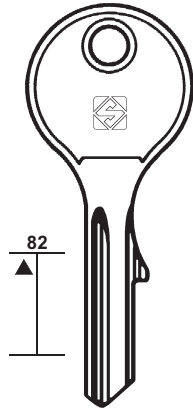

KARDEX

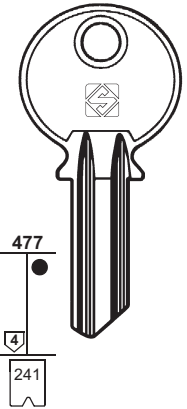
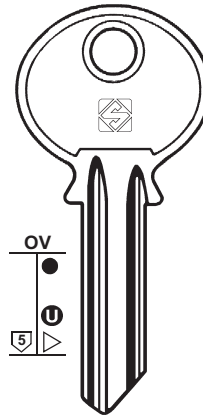
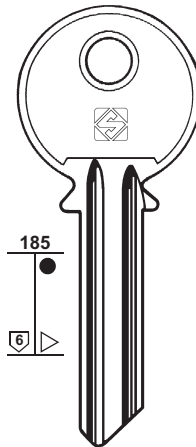

L... 5401-5650

NOBO

PER:  
FOR:

## VIRO

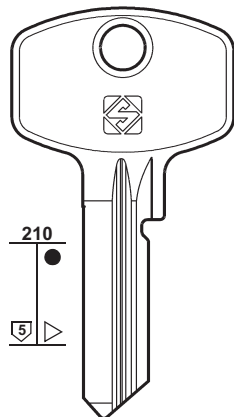

VI15R

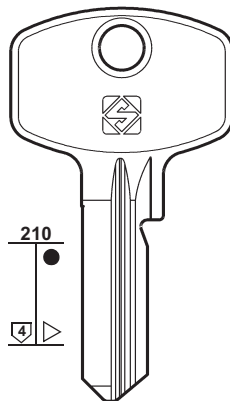

VI16R

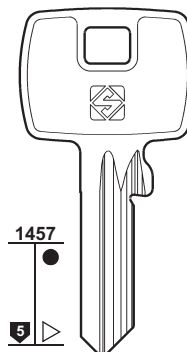

VI18R

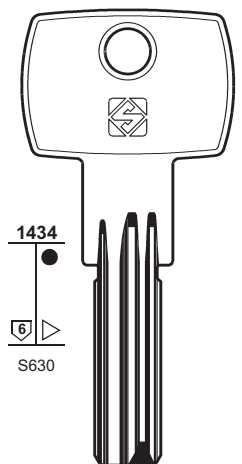

VI19  
EURO-PRO

KÖNIG



FEB

PER:  
FOR:

# VIRO

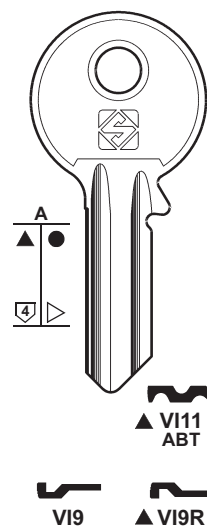
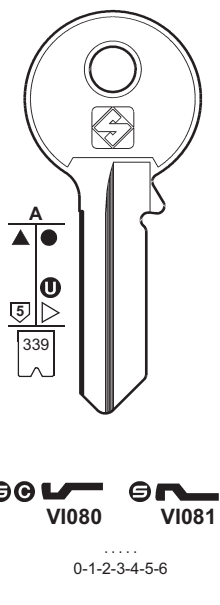
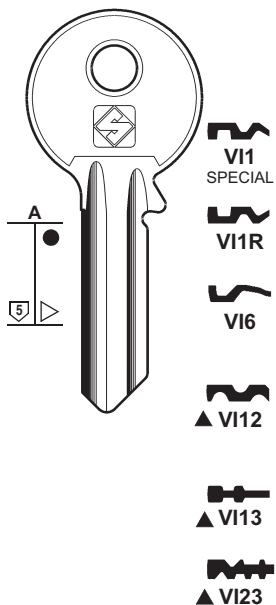
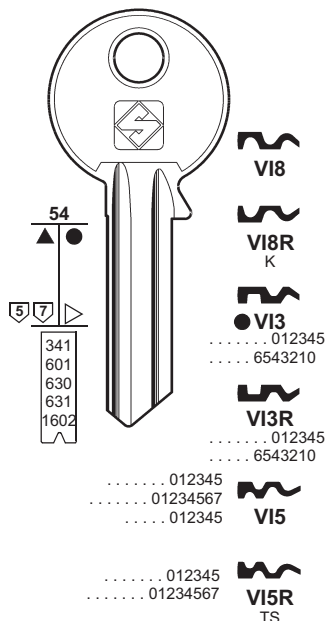

# 187

PER / FOR

- VIRO (I)**  
 ABT  
 ABUS  
 BERAM  
 BURG  
 FAI  
 ROYAL  
 WEISSENFELS  
 + ABLOY (4)  
 + ELCA (68)  
 + FAI (76)  
 + TESA (166)

PER:  
FOR:

# VIRO

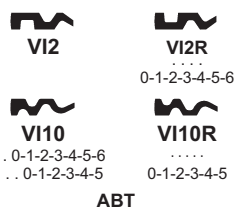
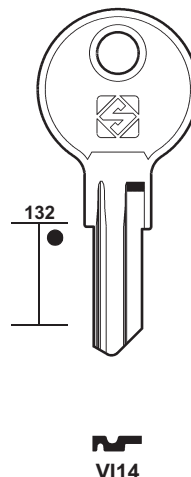
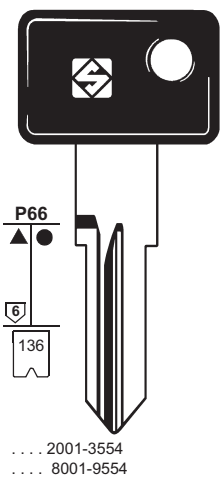
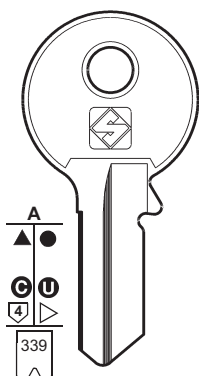
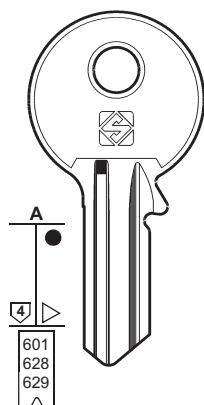

PER:  
FOR:

# VIRO

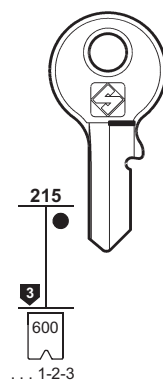
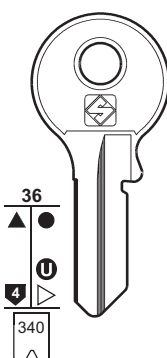
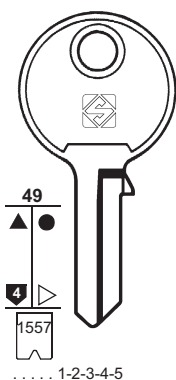
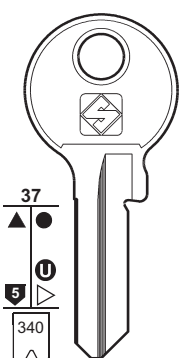
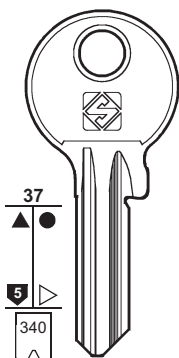



# 188

PER / FOR

**VIS** (I)

**VISO** (RC)

- 👁️ FORT (81)
- 👁️ YETI (198-199)

**VISONIC** (RC)

- 👁️ ALPHA (15)

**VJATKA** (RUS)

**VÖGEL** (CH)

- 👁️ BAAL (25)

**VOKO** (D)

- 👁️ CES (42)
- 👁️ DOM (62)
- 👁️ JOWIL (100)

**VOLGOGRAD** (RUS)

**VOLKOVYSK** (RUS)

**VOUGA** (BR)

**VS** (D)

- 👁️ JUNIE (101)

**WALE** (RC)

- 👁️ YALE (195)

**WALLY** (I)

AKKA  
MOREAUX

**WANGGUAN** (RC)

**WANJIN** (PRC)

HOOPLY

PER: FOR:	VIS	VJATKA	VOLGOGRAD	VOLKOVYSK	
	31 5	1101	1081	1081 5	1081

PER: FOR:	VOUGA	WALLY			
	1533	A 9	A 6	A 5 620	A 4 620
				1-2-3-4-5-6-7-8 MOREAUX	1-2-3-4-5-6-7-8

PER: FOR:	WALLY			WANGGUAN	WANJIN
	H 3 619	11 5	11 4	401	1603 7
	1-2-3-4-5-6-7-8				

<b>PER: WASA-IVANA</b> <b>FOR:</b>	<b>WAUS</b>	<b>WEBER</b>	

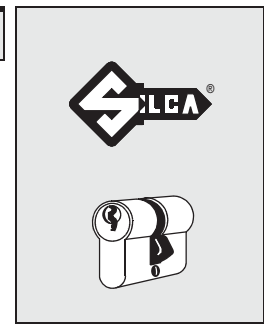

# 189

<b>PER / FOR</b>
<b>WASA-IVANA (PL)</b>
<b>WASO (D)</b> 👁️ CES (41-42)
<b>WAUS (P)</b>
<b>WB (F)</b> 👁️ KKL (107)
<b>WEBER (D)</b> WECO
<b>WEBSTER (GB)</b>
<b>WECO (D)</b> 👁️ CES (41-42) 👁️ WEBER (189) 👁️ YALE (194)
<b>WEISER (USA) (GB) (B)</b> FALCON FICHET IDEAL-SECURITY KAWE + 👁️ FALCON (76)
<b>WEISSENFELS (D)</b> 👁️ VIRO (187)
<b>WELKA (I)</b> + 👁️ YALE (193)

<b>PER: WEBSTER</b> <b>FOR:</b>	<b>WEISER</b>		
		<b>FICHET</b> <b>KAWE</b>	

<b>PER: WEISER</b> <b>FOR:</b>	<b>WELKA</b>			
<b>FALCON</b>	<b>IDEAL SECURITY</b>			



# 190

PER / FOR

**WELKA** (I)

+ **YALE** (193)

**WEPA** (D)

**JOWIL** (100)

**WESCO** (D)

**KIFERM** (106)

**LAS** (110)

**WESLOCK** (USA)

**WEST** (J)

**WFE** (D)

**WHALE** (i)

**GLOBE** (87)

PER:  
FOR:

## WELKA

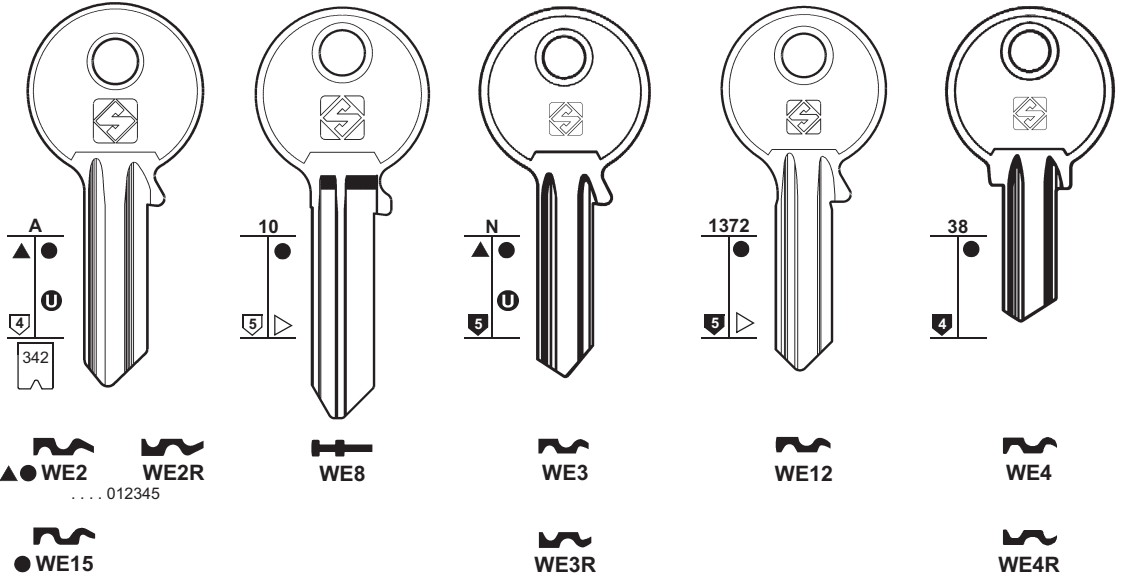

PER:  
FOR:

## WESLOCK

## WEST

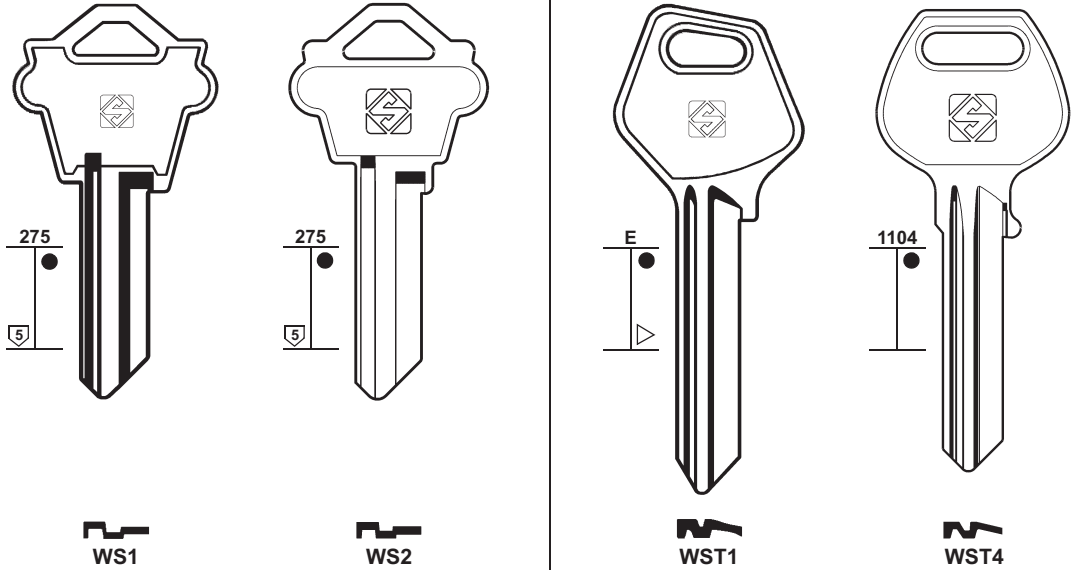

PER:  
FOR:

## WEST

## WFE

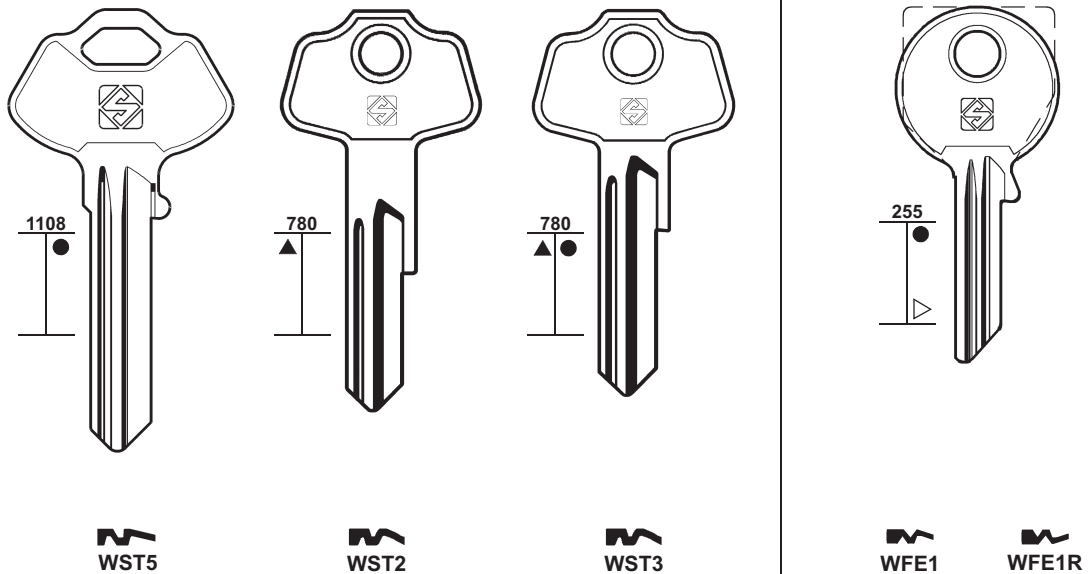

PER:  
FOR:

# WHITCO

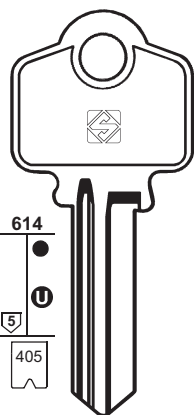

..... 0123456789A



WC1

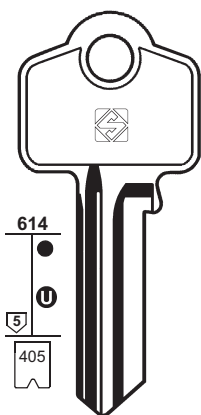

..... 0123456789A



WC2

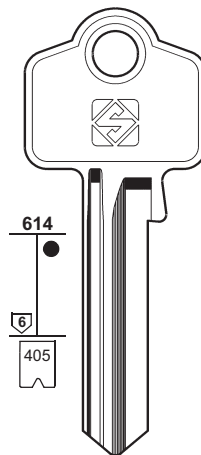

..... 0123456789A



WC3



# 191

PER / FOR

WHITCO (AUS)

WIGRO (D)

WILKA (191)

WILKA (D)

CFP  
DIERRE  
DORMA  
EMKA  
GBS  
JORE  
TOP  
VBH  
WIGRO  
+ BLASER (32)

PER:  
FOR:

# WILKA

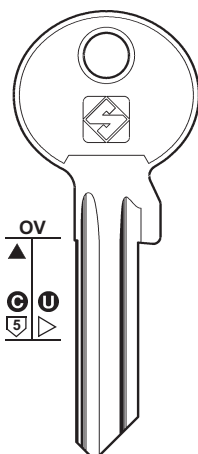

WK1X

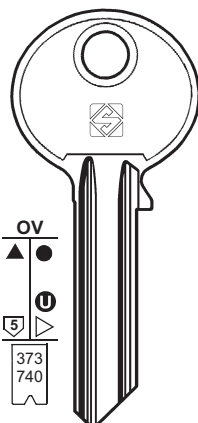

..... 123456789  
..... 400001-430000



WK1

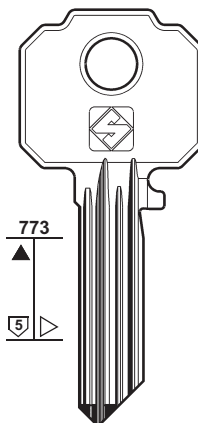

WK59R WK49R  
WK60R WK50R  
WK63R WK51R

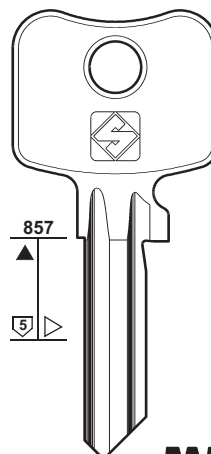

WK69  
WK55 WK68R

JORE - TOP - WIGRO

EMKA - DIERRE - DORMA - VBH

PER:  
FOR:

# WILKA

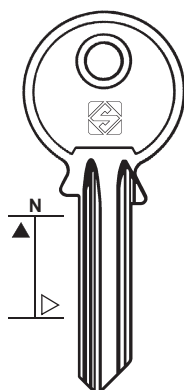

WK3

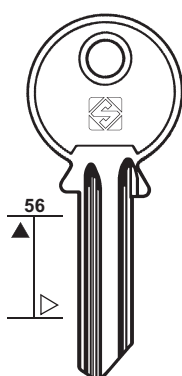

WK8



WK8R

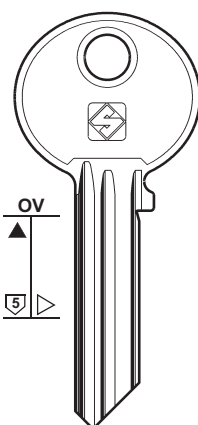

WK7	WK26	WK31	WK36	WK18
WK16	WK27	WK32	WK37	WK19
WK46	WK28	WK33	WK38	WK20
WK48	WK29	WK34	WK39	WK21
WK30	WK35	WK40	WK22	
WK5				

CFP - GBS



192

PER / FOR

WILKA (D)  
+ BLASER (32)

WILLACH (D)  
HUWIL (94)

WILLENHALL (GB)  
GIBBONS (86)

WILSON BOHANNON (USA)  
VENLOCK

WINFIELD (RC)  
YETI (198-199)

WINFOR (GB)  
MERONI (124)

WINKHAUS (D)  
TOK-WINKHAUS

WINLOCK (GB)

WINNER (F)  
GABON (84)

WIREROPE (HK)

W.M.S. (GB)  
I.R.  
TITUS  
+ AVOCET (24)

WOC (F)  
YALE (193)

PER:  
FOR:

WILKA

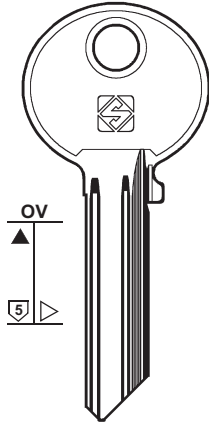

- WK6
- WK6R
- WK25
- WK25R
- WK44R
- WK4
- WK41R
- WK15
- WK3R
- WK53R
- WK54R
- WK9
- WK42R
- WK14
- WK13
- WK12
- WK11
- WK2
- WK10
- WK45R
- WK52R
- WK2R
- WK17R
- WK47R
- WK56R

PER:  
FOR:

WILKA

WILSON BOHANNON

WINLOCK

857  
6+6  
S621

OV  
5

WK70  
10001-43000

WK45X

WK71X

397  
5

WH1

VENLOCK

49

WLC1

PER:  
FOR:

WIREROPE

W.M.S.

A  
5

2  
5

49  
4

132  
5

WR1

WR2

WR3

WR4

WR5R







A  
4

A  
5

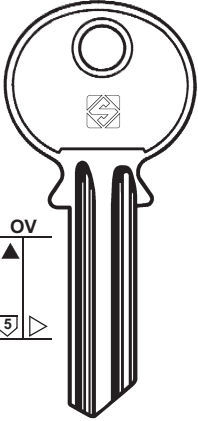
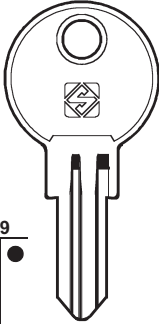
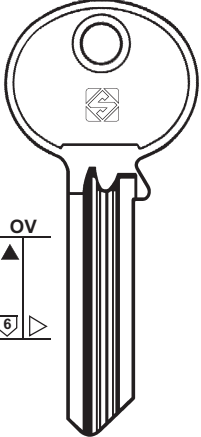
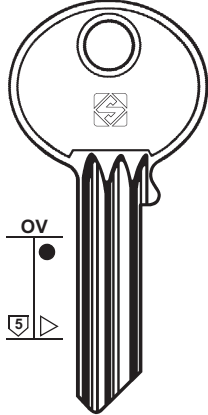
WMS1

WMS2





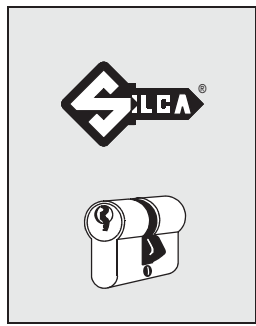





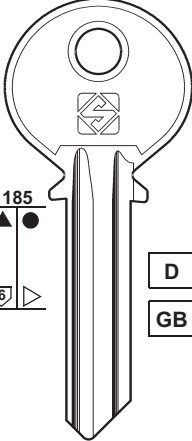
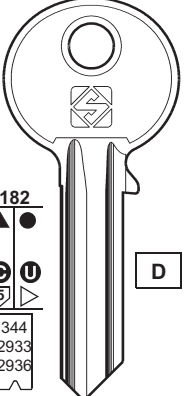
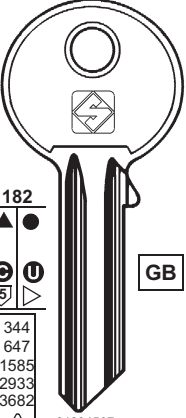
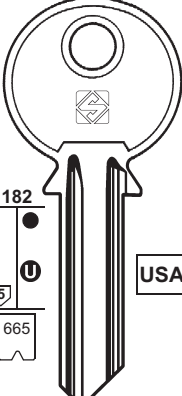
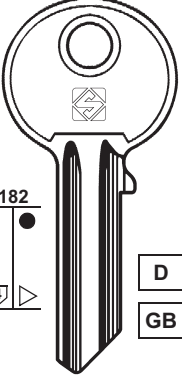

PER: FOR:	WS	XIEHE	YALE	
				
	OV ▲ 5	49 ● 4	OV ▲ 6	OV ▲ 5
	 			
			<b>D</b> <b>GB</b>	<b>D</b> <b>GB</b>



# 193

- PER / FOR**
- WS (D)**
  - WÜRTH (D)**
    - CORBIN (53)
    - HUWIL (94)
  - XIEHE (PRC)**
  - YAC (F)**
    - RONIS (147)
  - YALE (D) (GB) (USA)**
    - BIRD
    - BKS
    - CARAT
    - CKS
    - KALE
    - LAREDO
    - PRIVE
    - ROC
    - UMF
    - WELKA
    - WOC
    - + ● BKS (30-31)
    - + ● HTV (93)
    - + ● URBIS (180)

**PER:  
FOR:** **YALE**

				
185 ▲ ● 6	182 ▲ ● 5	182 ▲ ● 5	182 ▲ ● 5	182 ▲ ● 4
<b>D</b> <b>GB</b>	<b>D</b> <b>C</b> <b>U</b> <b>5</b>	<b>GB</b> <b>C</b> <b>U</b> <b>5</b>	<b>USA</b> <b>U</b> <b>665</b>	<b>D</b> <b>GB</b>
 	 	 		 
	BIRD - BKS - CARAT CKS - KALE - LAREDO ROC - WELKA - WOC		PRIVE	UMF

**PER:  
FOR:** **YALE**

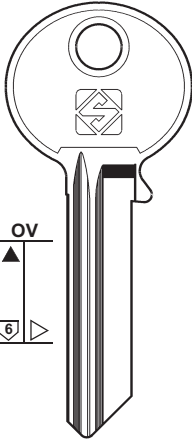
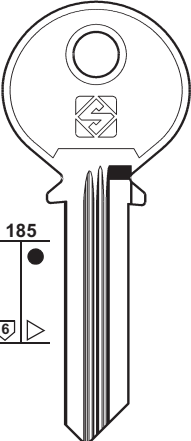
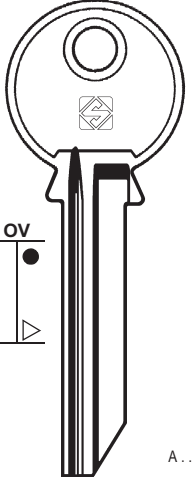
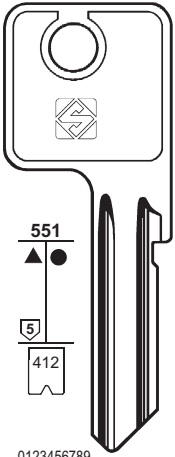
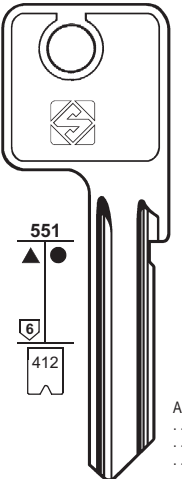
				
OV ▲ 6	185 ▲ ● 6	OV ▲ ●	551 ▲ ● 5	551 ▲ ● 6
<b>YA84</b> <b>YA84R</b>	<b>YA86</b> <b>YA86R</b>	<b>YA67</b>	<b>YA35</b>	<b>YA64</b> <b>YA64R</b>
	<b>YA85R</b>	<b>USA</b>	<b>USA</b>	<b>USA</b>
			A ..... 0123456789 ..... 0123456789 ..... 0123456789	<b>YA34</b> ● A ..... 0123456789 ..... 0123456789 ..... 0123456789 ..... 0123456789



194

PER / FOR

YALE (D) (GB) (USA)

ABUS  
BENDIX  
BKS  
CAB  
CHICAGO  
COLE-HERSEE  
HUDSON  
SOUTHCO  
SUREX  
WECO

+ BKS (30-31)

+ HTV (93)

+ URBIS (180)

PER:  
FOR:

YALE

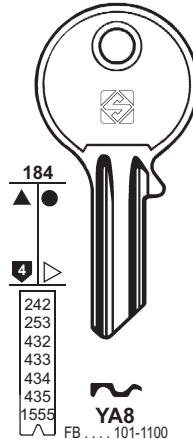
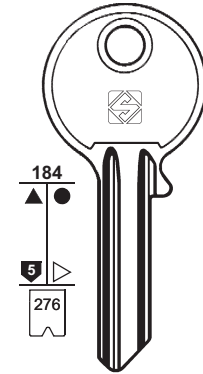
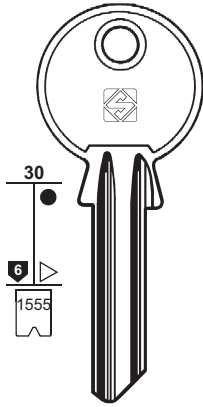

YA8E ▲

BM...1-1000  
KA...1-1000  
KB...1-1024  
AT...1-1040  
A...1-1100  
DB...1-1100  
...1-1600  
B...1-1600  
BS...1-1600  
D...1-1600  
E...1-1600  
F...1-1600  
IC...1-1600  
JA...1-1600  
JD...1-1600  
KV...1-20025  
KD...1-4950  
ABS...1-6000  
D...1-750  
R...10-101  
KA...1001-2000  
FB...101-1100  
FP...101-1100  
R...101-160  
KV...100026-120025  
BT...1451-2250  
KV...20026-40025  
CM...250-1349  
DC...251-1350  
FS...297-1396  
KV...120026-140025  
KV...40026-60025  
FD...501-1600  
KV...60026-80025  
KV...80026-100025

● YA30  
ABS ...  
7537-8336

▲ YA30R

YA8

FB... 101-1100  
FP... 101-1100  
R... 101-160  
MC... 101-850

YA8R  
SUREX

YA21 ●

TBS ... (AB) 401-450  
SC ... (AB) 101-150

YA22 ●

SC ... 1-50  
TBS ... (AC) 451-500

YA23 ▲

SC ... (AD) 51-100  
TBS ... (AD) 501-500

YA15 ▲

SX ... 1-1000  
VR ... 1-4000  
BX ... 1-500  
VW ... 1-4000

YA8ER ▲

USA GB

YA24 ●

TBS ... (BC) 551-600

YA25 ●

SC ... (BC) 201-250  
TBS ... (BD) 601-650

YA26 ●

SC ... (CD) 151-200  
TBS ... (CD) 651-700

YA15R ●

USA GB

BKS - WECO

RP ... 1001-3400

▲ YA32

YA32R

YA3

YA3R



D GB



D GB

PER:  
FOR:

YALE

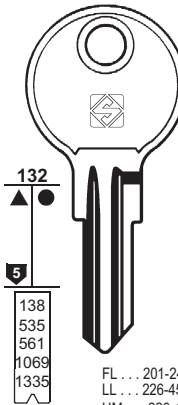
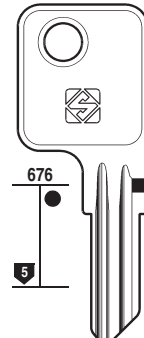
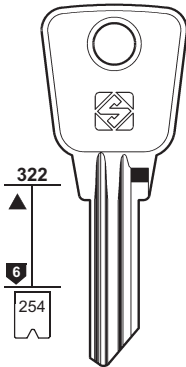
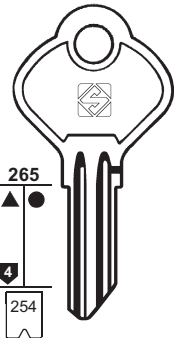

YA66 ●

● YA66R  
... F8 1001-2500  
... F9 1001-2500

YA68 ●

● YA68R

YA69 ●

● YA69R

▲ YA20

▲ YA20R

YA19

YA19R ●

YA65

YA65R

FL ... 201-240  
LL ... 226-450  
UM ... 226-450  
... 500-550  
... 600-650

YA18  
SOUTHCO

YA18R

YA17

YA17R

DC ... 551-952  
TOK ... 1-99  
RS ... T 1-99

LT ... 1-100  
LC ... 1-100

YA4  
HC ... 001-202  
KC ... 251-500

YA4R  
CH ...  
251-750



USA GB



USA



USA

USA GB

ABUS - BENDIX - CAB - CHICAGO  
COLE-HERSEE - HUDSON

PER:  
FOR:

YALE

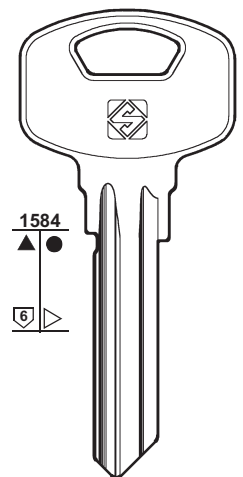
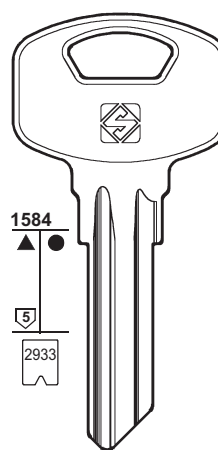
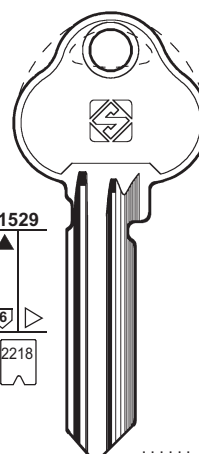
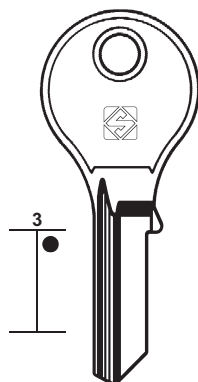
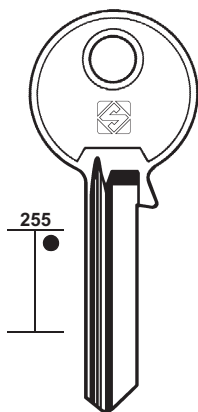

YA16L

YA16RL

YA16

YA16R

YA88  
X5

YA89

YA91



D GB



D GB



GB

GB

PER:  
FOR:

# YALE

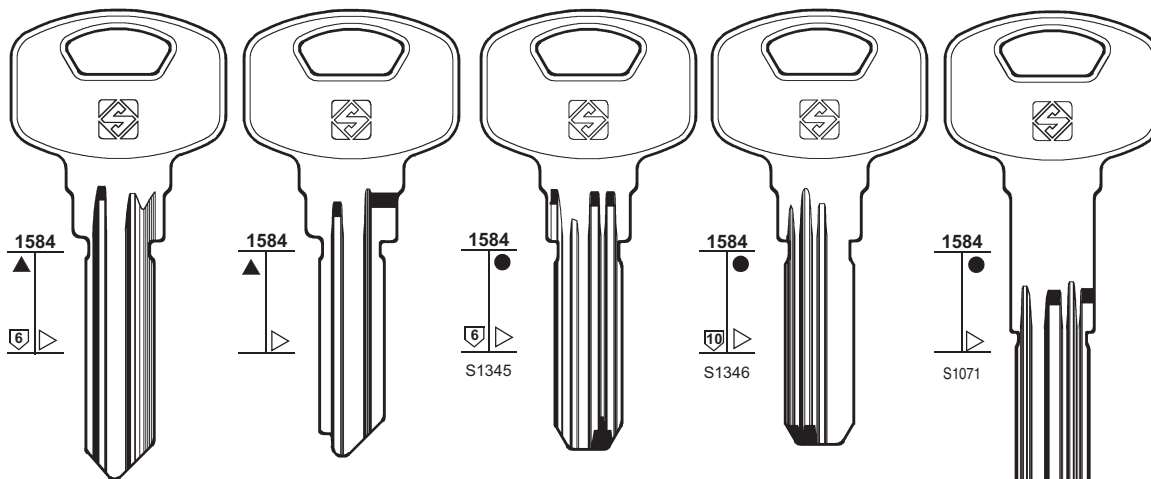

**YA93**

**YA87**  
KTM

**YA94**  
"1000 Series"



**YA95R**  
"2000 Series"



**YA90**



# 195

PER / FOR

**YALE** (I)  
FERCO  
SOS  
WALE

PER:  
FOR:

# YALE (I)

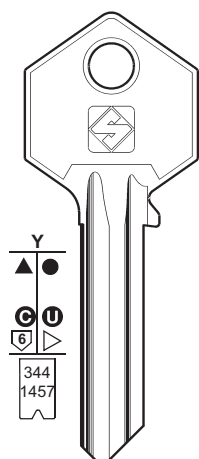

..... 0-1-2-3-4-5-6-7-8-9  
..... 0-1-2-3-4-5-6-7-8

**YA31** **YA31R**

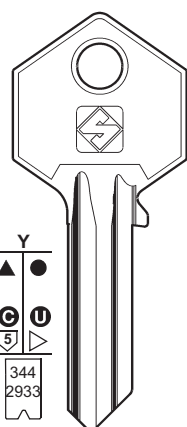

..... 0-1-2-3-4-5-6-7-8-9

**YA226** **YA227** ..... 0123456789

..... 0-1-2-3-4-5-6-7-8-9

FERCO - WALE

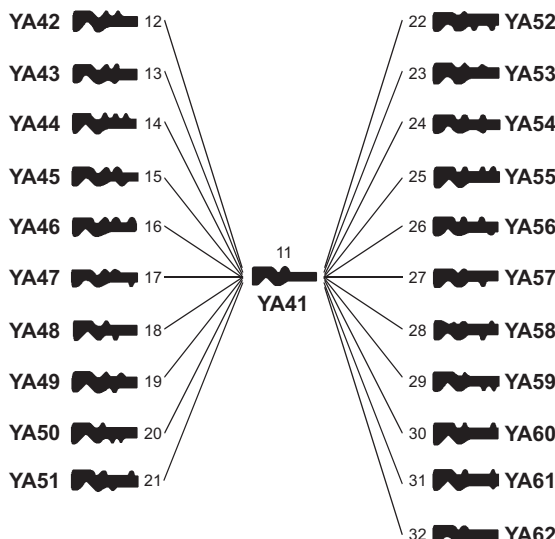

PER:  
FOR:

# YALE (I)

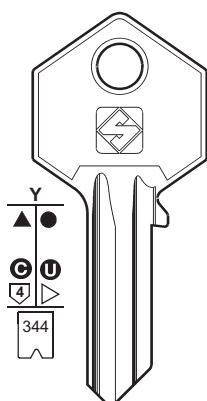

..... 0-1-2-3-4-5-6-7-8-9

**YA6R**

**YA6**

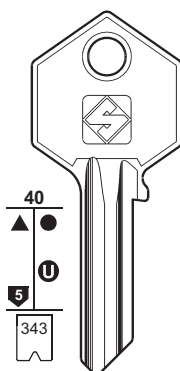

..... 1-2-3-4-5-6-7-8

**YA7**

**YA7R**

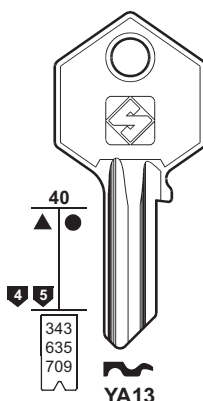

..... 1-2-3-4-5-6-7-8  
..... 1-2-3-4  
..... 0-1-2-3-4-5

**YA13R**

..... 0-1-2-3-4-5-6-7-8



SOS - WALE



WALE

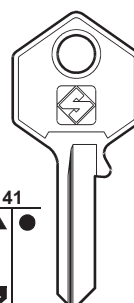

**YA14**

**YA14R**



MIGNON

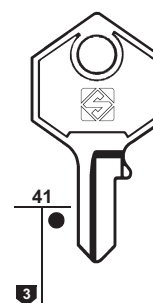

**YA33**



MIGNON



# 196

### PER / FOR

YALE (I) (D) (GB) (USA)

+ BKS (30-31)

+ HTV (93)

+ URBIS (180)

PER:  
FOR:

## YALE (I)

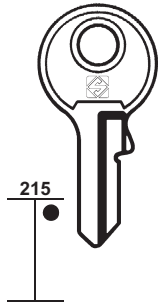

YA74



YA74R



MIGNON



CS28



CS28R



MIGNON

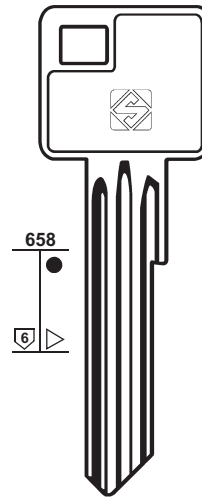

YA39

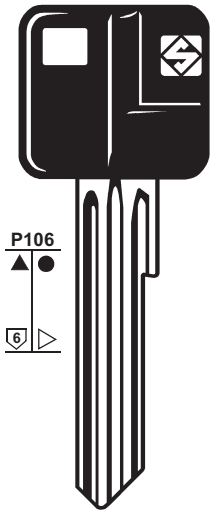

YA39P

PER:  
FOR:

## YALE (I)

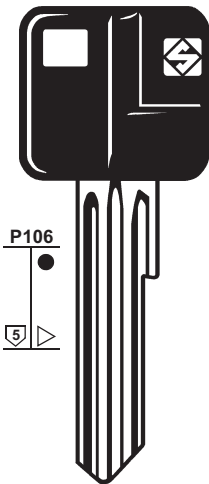

YA40P

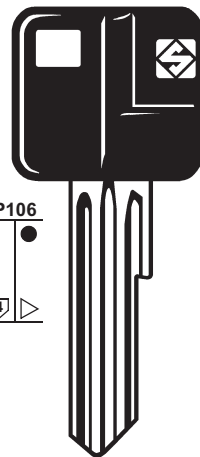

YA73P

## YALE (USA)

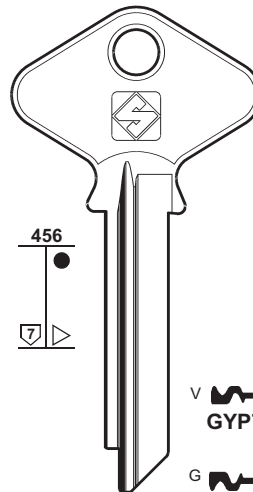

V GYP7R



G GYP7



GA GYA7

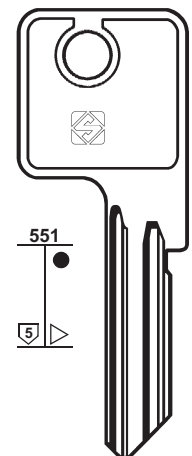

G GYP8



V GYP8R

PER:  
FOR:

## YALE

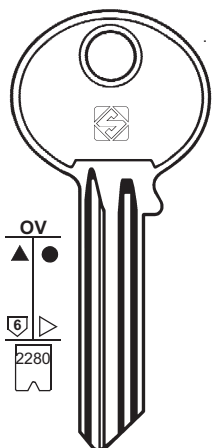

D GB

GA GYA6  
..... 0-1-2-3-4-5-6

GC GYC6

GG GYG6

GB GYB6

GE GYE6

GH GYH6

GD GYD6

GF GYF6

GK GYK6

GYP6B

G YA2

V YA2R

VYP6A

VA VYA6

VC VYC6

VG VYG6

VB VYB6

VE VYE6

VH VYH6

VD VYD6

VF VYF6

VK VYK6

VYP6B

VYP6D

PER:  
FOR:

# YALE

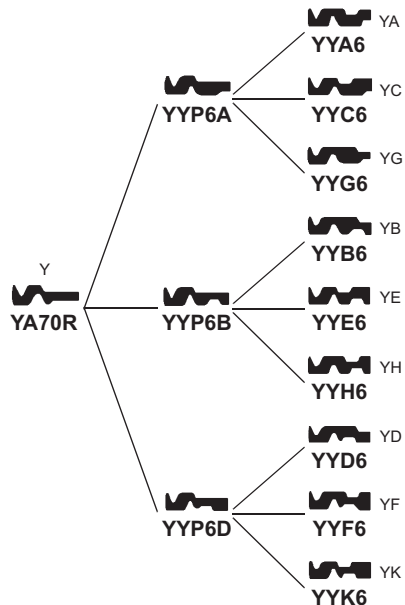
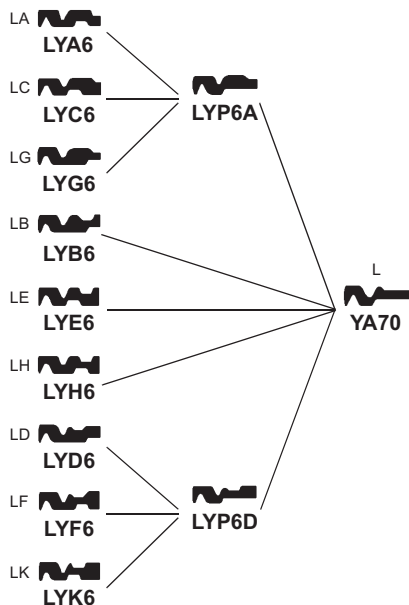
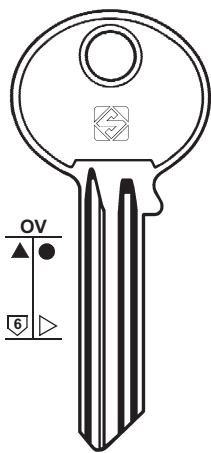

# 197

PER / FOR

**YALE (D) (GB)**  
 + BKS (30-31)  
 + HTV (93)  
 + URBIS (180)

**YALTRES (RA)**  
 FTH (82)

**YANEDIS (GB)**  
 ETAS (70)

PER:  
FOR:

# YALE

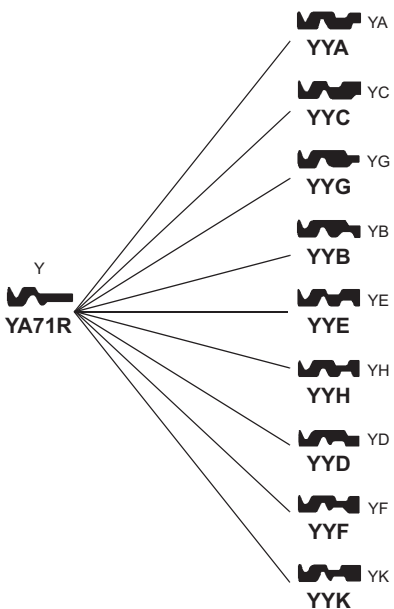
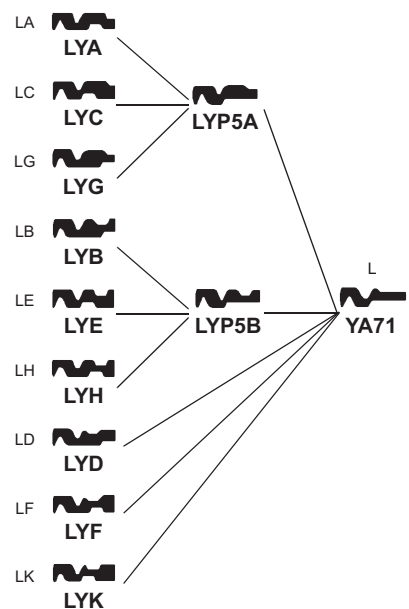
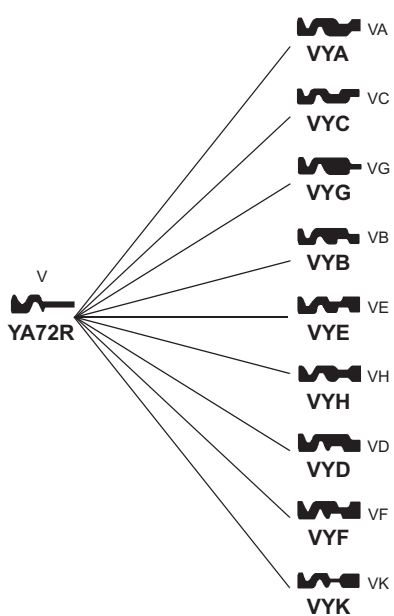
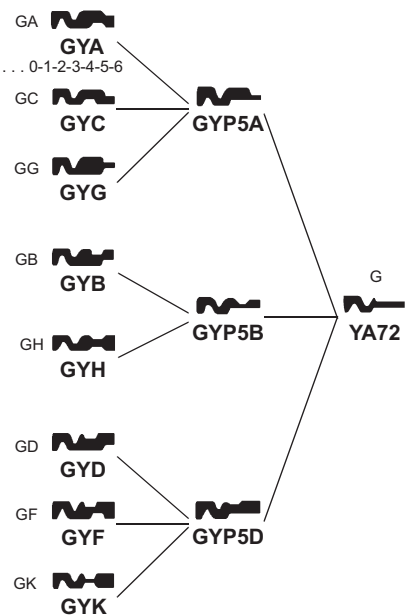
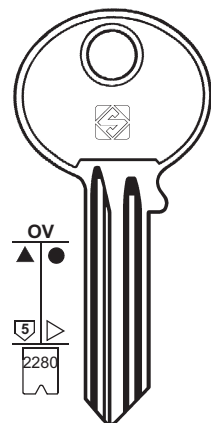



# 198

PER / FOR

**YANMAR** (J)

**YARDENI** (IL)

**YEMAR** (E)

UCEM (175)

**YETI** (PL)

FAB (74)

LOB (114)

MCM (121)

**YETI** (RC)

AKIRA  
ASIA  
BEDI  
BELL  
DEHA  
FOUR-CIRCLE  
HAIDE  
HEAD  
HEMY  
HERMES  
LOTUS  
RAM  
ROYAL  
SANCHUN  
SEZAN  
SWAN  
VELO  
VISO  
WINFIELD

PER: **YANMAR**

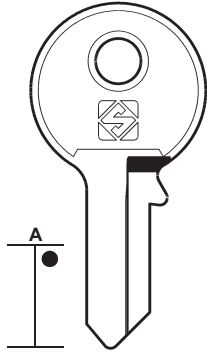

**YAR1**



**YARDENI**

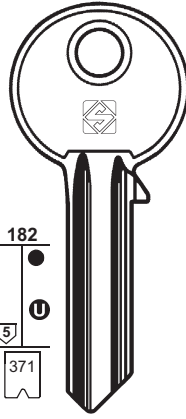

**YD1** ▲**YD1R**  
..... 0-1-2-3-4-5-6-7-8-9

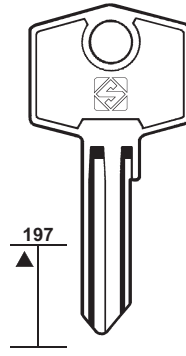

**YD2** **YD2R**

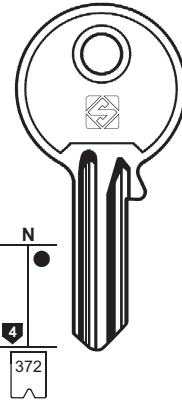

**YD4** **YD4R** ▲

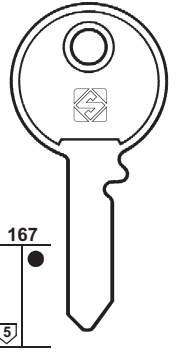

**YD5R**



PER:  
FOR:

**YARDENI**

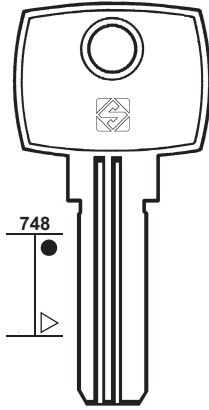

**YD3R**

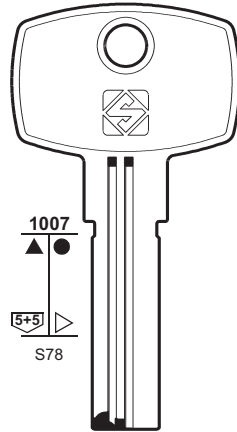

**YD6R**

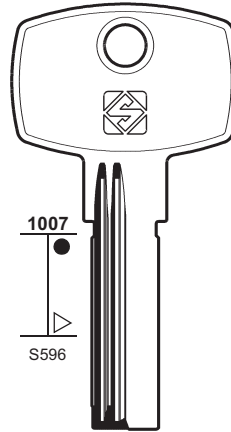

**YD7R**

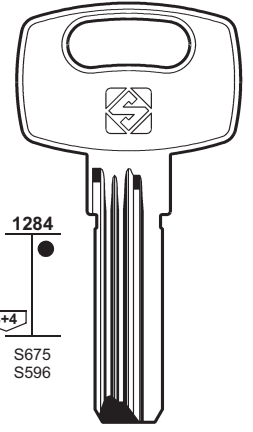

**YD13R** **YD14R**  
XL 6



PER:  
FOR:

**YETI**

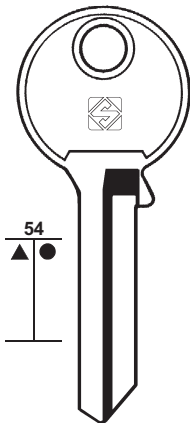

**YT6** **YT6R**

●**YT12** **YT12R** ▲

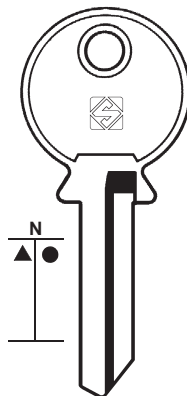

**YT7** **YT7R**

**YT13** **YT13R**

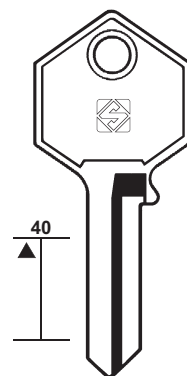

**YT8** **YT8R**

●**YT14** **YT14R** ●

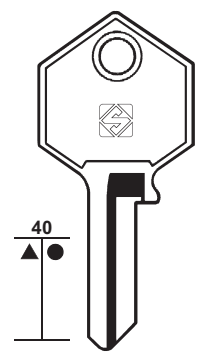













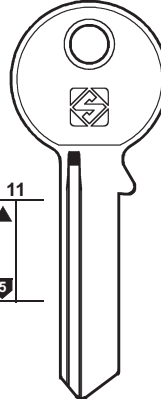
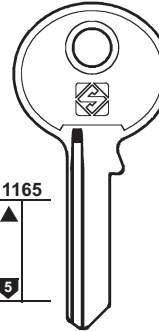







**YT1** **YT1R**

▲**YT3** **YT3R** ▲

AKIRA - ASIA - BEDI - BELL - DEHA  
FOUR-CIRCLE - HAIDE - HEMY - HERMES  
HEAD - LOTUS - RAM - ROYAL - SANCHUN  
SEZAN - SWAN - VELO - VISO - WINFIELD



mm 40

YETI			YUN HUAN	
				
277	12	215	11	1165
 YT9  YT9R  YT2  ▲YT2R	 YT10  YT10R  YT4  ▲YT4R BENCO NOVA	 ●YT11  YT11R  ●YT5  YT5R ●	 YUH2R	 YUH1R
 mm 30	 mm 25	 mm 20		
AKIRA - ASIA - BEDI - BELL - DEHA - FOUR-CIRCLE HAIDE - HEMY - HERMES - HEAD - LOTUS - RAM - ROYAL SANCHUN - SEZAN - SWAN - VELO - VISO - WINFIELD				

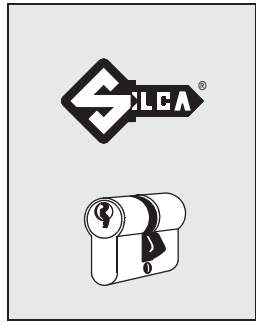

# 199

**PER / FOR**











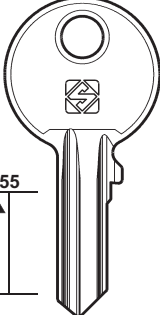
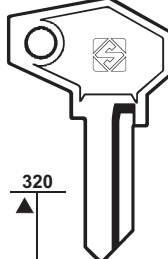
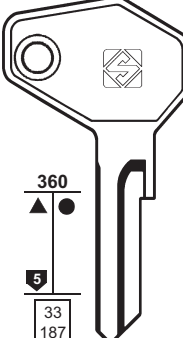
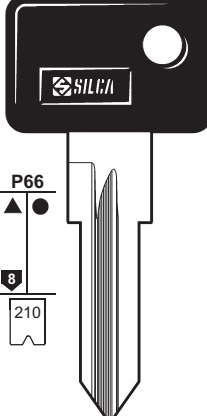

**YETI (RC)**  
 AKIRA  
 ASIA  
 BEDI  
 BELL  
 BENCO  
 DEHA  
 FOUR-CIRCLE  
 HAIDE  
 HEAD  
 HEMY  
 HERMES  
 LOTUS  
 NOVA  
 RAM  
 ROYAL  
 SANCHUN  
 SEZAN  
 SWAN  
 VELO  
 VISO  
 WINFIELD







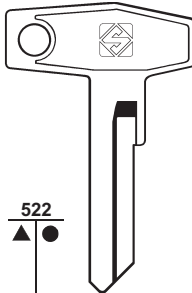
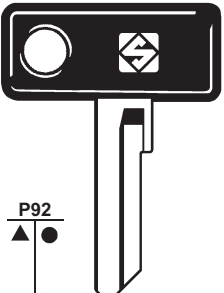
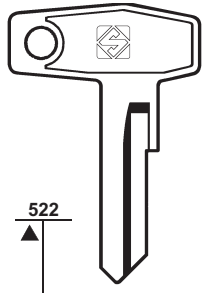
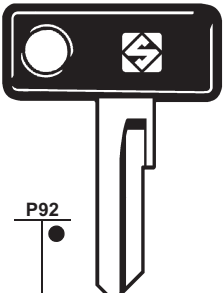

**YONGTAI (RC)**  
 TRI-CIRCLE (173)

**YUN HUAN (PRC)**

**YVEL (F)**  
 RICOUARD (146)

**ZADI (I)**  
 + BRETER (34)

ZADI (I)			
			
55	320	360	P66
	4	5	8
	54 186	33 187 389	210
 ZD5  ZD5R  ZD4  ZD4R	 ZD8 ... 1-253  ZD6 2 ... 1-624	 ZD7 ... 1-1625 ... 9001-9500 E ... 1-500 E ... 501-710	 ZD14RP ... 5001-6475 C ... 5001-6475
			

ZADI (I)			
			
522	P92	522	P92
4 5	4 5	4	4
53 187 389	53 187 389	53 187 743 3205	53 187 743 3205
 ZD9 ... 1-1625 E ... 500 E ... 501-710 ... 9001-9500 ... 5001-6278	 ZD9P ... 1-1625 E ... 500 E ... 501-710 ... 9001-9500 ... 5001-6278	 ZD11 ... 1-1625 E ... 1-500 ... 5001-6278 E ... 501-710 ... 1234 H ... 100-341	 ZD11P ... 1-1625 E ... 1-500 ... 5001-6278 E ... 501-710 ... 1234 H ... 100-341
			



# 200

### PER / FOR

**ZADI (I)**  
BULLOCK  
+ BRETER (34)

**ZANETTI A. (I)**  
GHIDINI  
OB  
ROLEX  
TAUB  
TOR

**ZANI (I)**  
BALLY  
FIC  
SINA  
ZETA  
+ ICSA (94)  
+ MORI E. (129)

**ZĚČĚ (HR)**  
CORBIN (53)

**ZEISS IKON (D)**  
BRUMME  
OTIS  
+ BAB (26)  
+ CORONA (55)

PER:  
FOR:

## ZADI

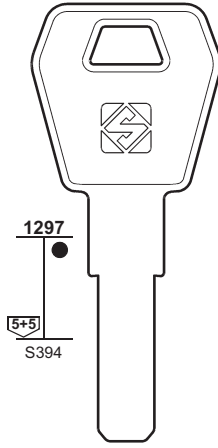

1297  
5+5  
S394

ZD25

BULLOCK

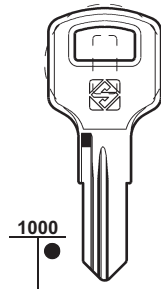

1000

ZD26R

## ZANETTI ANGELO

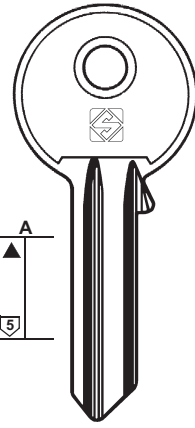

A  
5

ZA2R

GHIDINI - OB - ROLEX - TAUB - TOR

PER:  
FOR:

## ZANI

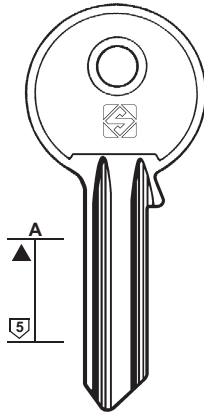

A  
5



ZI1



ZI1R

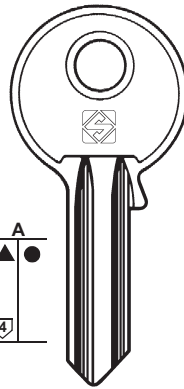

A  
4



ZI4



ZI4R

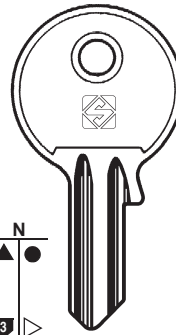

N  
5



ZI2R



ZI3R

BALLY - FIC - SINA - ZETA

BALLY

## ZEISS IKON

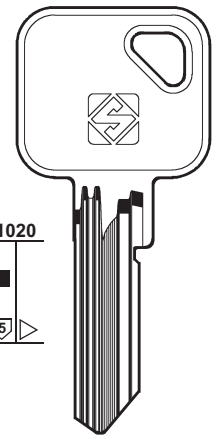

1020  
5



ZE45

PER:  
FOR:

## ZEISS IKON

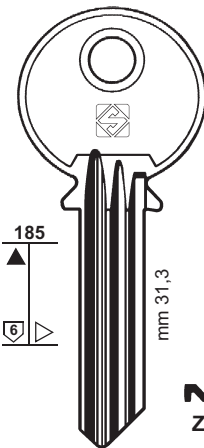

185  
5

mm 31,3



ZE42



ZE14  
ZC



ZE14R  
ZA



ZE11  
ZD



ZE11R  
ZB

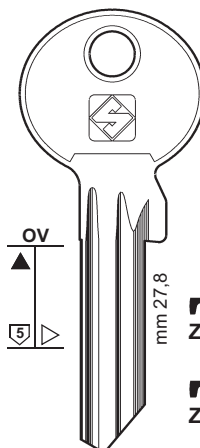

OV  
5

mm 27,8



ZE34X  
SN1



ZE34RX  
SN2



ZE39X  
SN3



ZE39RX  
SN4



ZE40X  
SN5



ZE1X  
N1



ZE1RX  
N2

BRUMME - OTIS

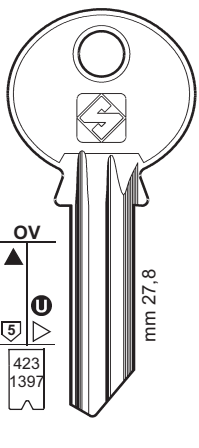

OV  
5  
423  
1397

mm 27,8



ZE15  
Z 461



ZE16  
Z 484



ZE13  
ZC



ZE13R  
ZA



ZE10  
ZD



ZE10R  
ZB



ZE34  
SN1



ZE34R  
SN2



ZE39  
SN3



ZE1  
N1



ZE1R  
N2

..... (TK5)  
1-2-3-4-5-6-7-8-9-0  
A-B-C-D-E-F-G-H-I-L  
..... (TK6)  
1-2-3-4-5-6-7-8-9-0  
A-B-C-D-E-F-G-H-I-L

BRUMME - OTIS



PER:  
FOR:

# ZEISS IKON

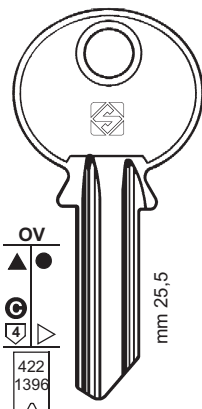

**ZE2**  
N 11  
.....(SK5)  
1-2-3-4-5-6-7-8-9-0  
A-B-C-D-E-F-G-H-I-L

BURG

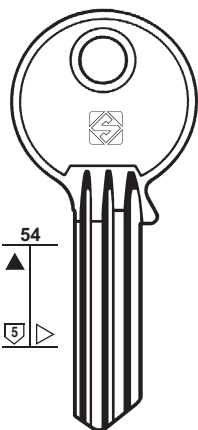

**ZE12**  
M

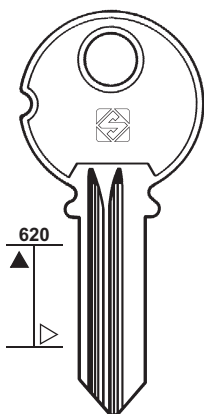

**ZE30**   **ZE30R**  
DS2   DS1

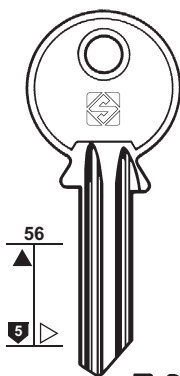

**ZE5**  
K5

**ZE5R** ▲ ●  
K60

**ZE7**

**ZE4**  
K3

**ZE3**  
K1

**ZE3R**  
K2



CORONA - FORTSCHRITT



# 201

PER / FOR

**ZEISS IKON (D)**  
BURG  
CORONA  
FORTSCHRITT  
+ 👁️ BAB (26)  
+ 👁️ CORONA (55)

**ZENI (GB)**

**ZENICA (F)**

**ZENITH (F) (I)**  
ARNOV  
AUBERT  
FO  
MONOBLOC  
QCP  
SIAM  
SICMA  
+ 👁️ CITY (51)  
+ 👁️ SIS (155)

**ZETA (I)**  
👁️ ZANI (200)

PER:  
FOR:

# ZENI

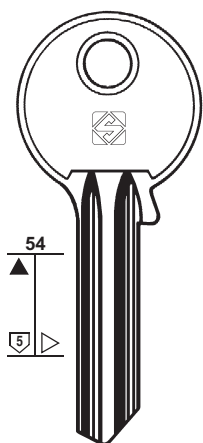

**ZN1**

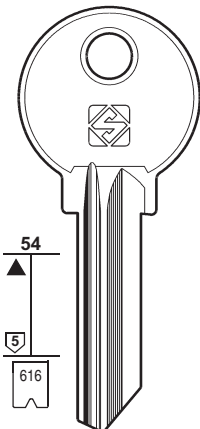

**CA14**   **CA8** ▲ Ⓡ  
170000-176310  
..... 0123456

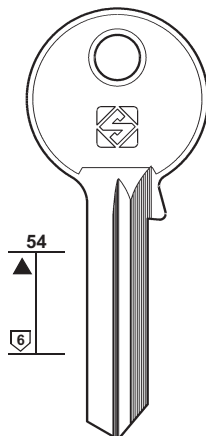

**CA13**

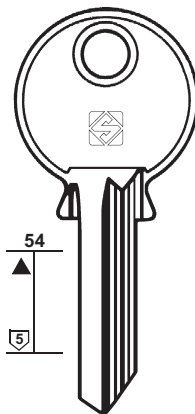

**CA12**

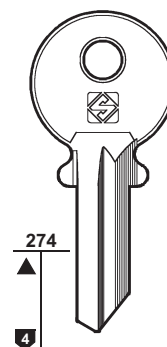

**CA6**

PER:  
FOR:

# ZENITH (F)

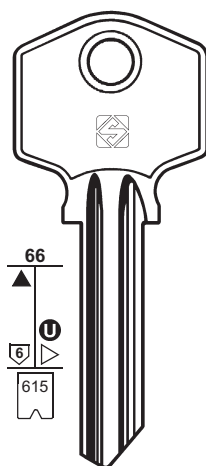

**CA11**  
..... 0123456  
..... 400001-435886

**CA11R** ▲

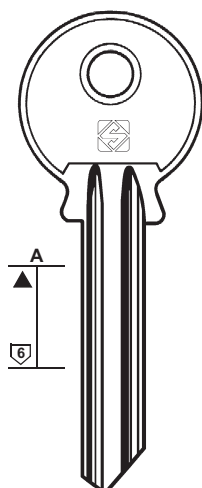

**CA10**   **CA10R**

ARNOV  
FO - MONOBLOC

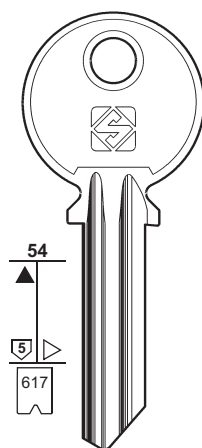

**CA15**  
..... 81000-88179

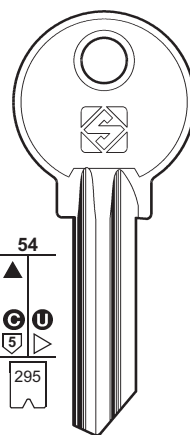

**CA2R**   **CA2**  
160 ... 000-999  
16 ... 1000-6288

QCP - SIAM

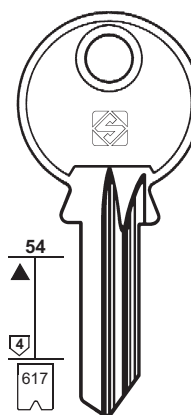

**CA7**  
..... 0-1-2-3-4-5-6  
..... 12500-15949

SICMA

AUBERT - FO



**202**

PER / FOR

ZHONGHENG (PRC)

PER:  
FOR:

ZHONGHENG

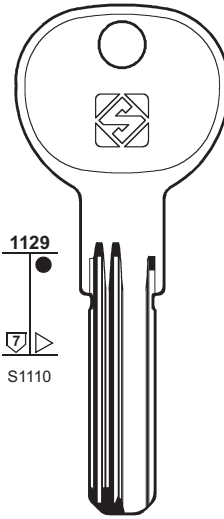

ZH1R



PER:  
FOR:

PER:  
FOR: