

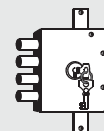

Double bit and pump keys
Chiavi doppia mappa e pompa
Doppelbart- und Pumpenschlüssel
Clés double panneton et à pompe
Llaves doble mapa y frontal
Chaves de duplo palhetão e bomba

FOR:
PER:

ANTONIOLI



3

FOR/PER

ANTONIOLI (I)
AUNO

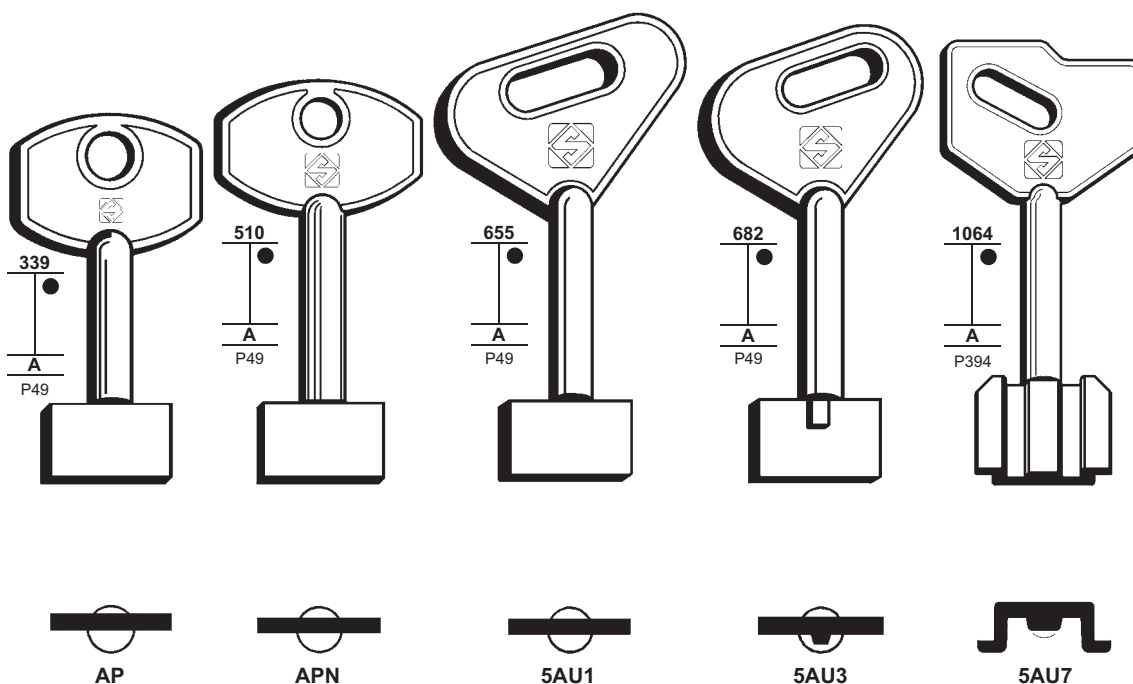

AUNO

AUNO

AUNO

FOR:
PER:

ANTONIOLI

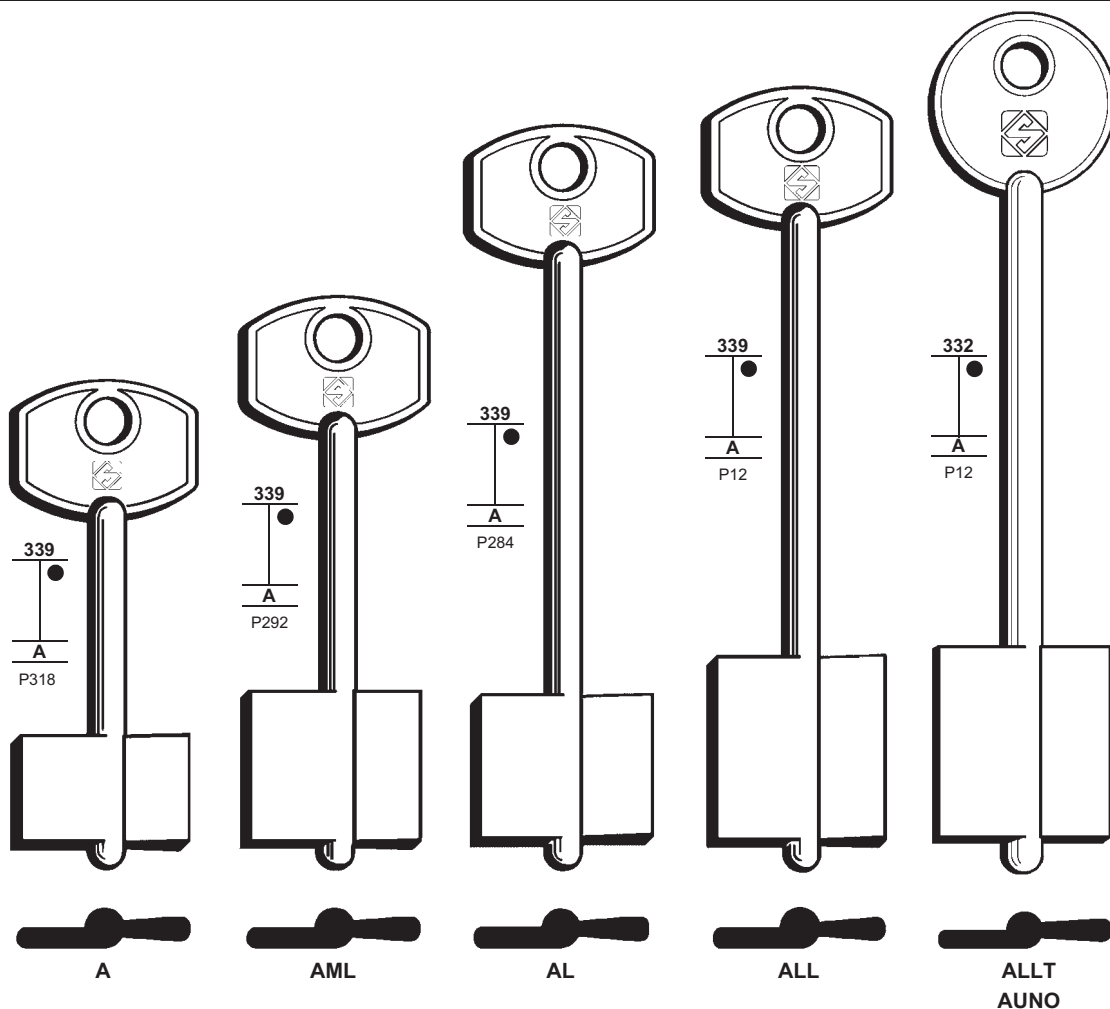

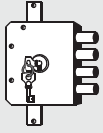

4

FOR/PER

ANTONIOLI (I)
AUNO

ASIAGHI (I)
JUWEL (37)

ASSA (S)
+ (70)

ATRA (I)

FOR:
PER:

ANTONIOLI

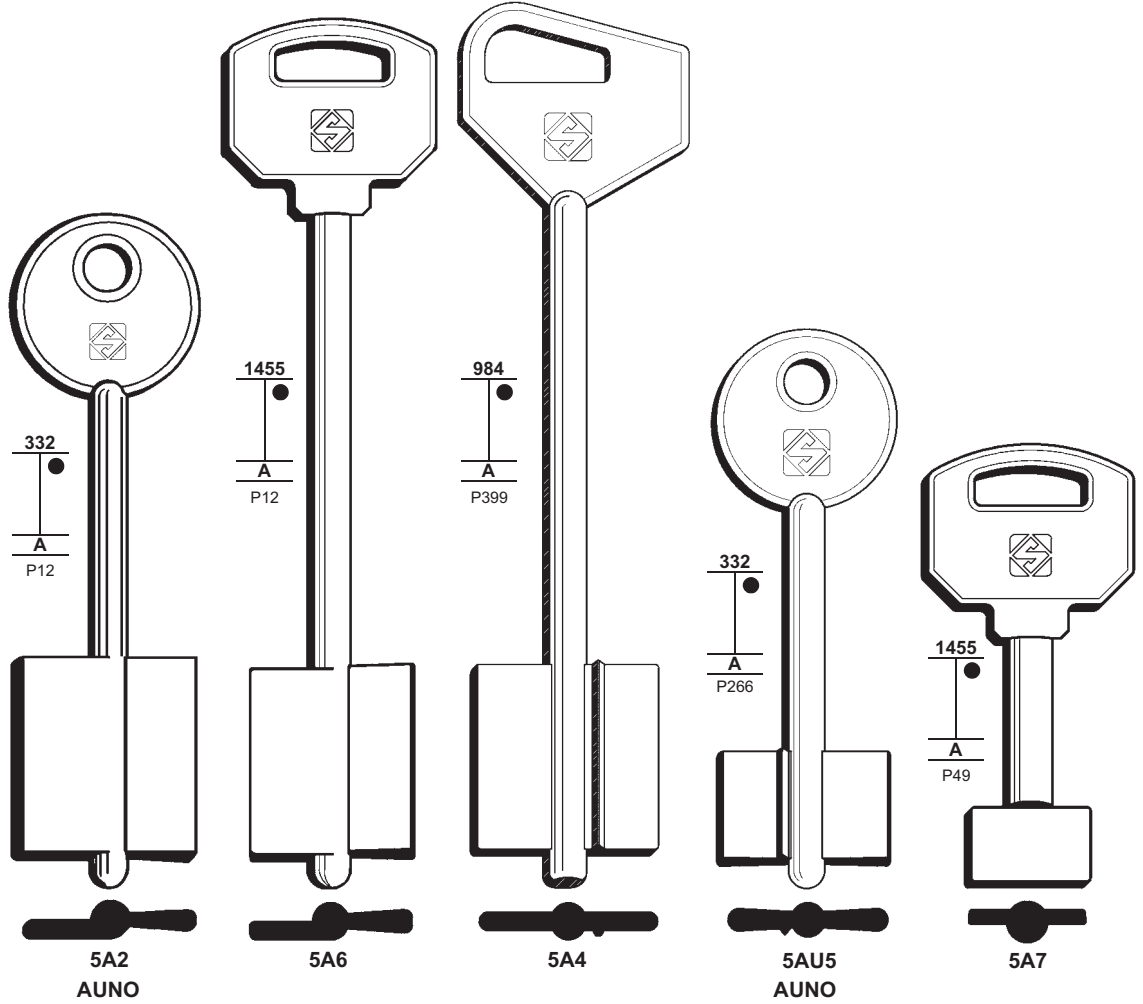

FOR:
PER:

ASSA

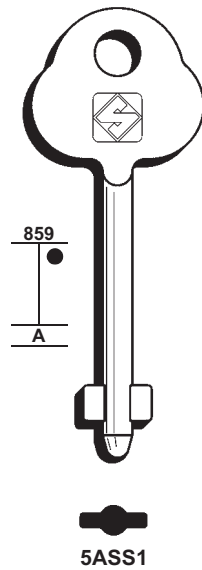

ATRA

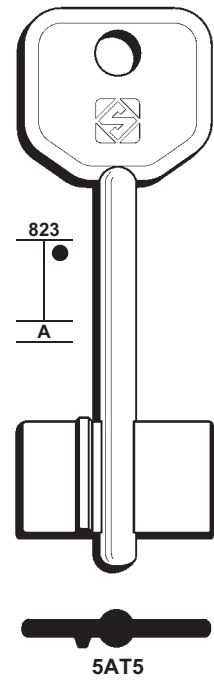
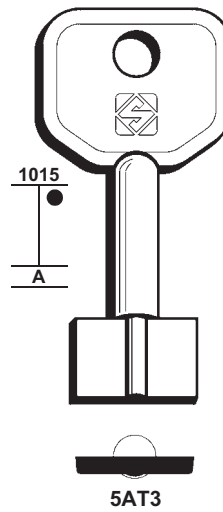

FOR:
PER:

ATRA

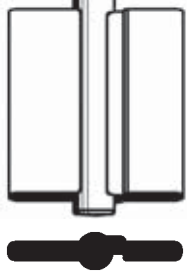

5AT13AP

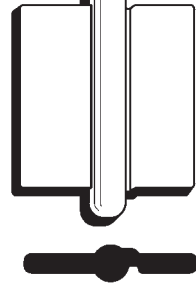
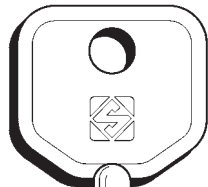

5AT9

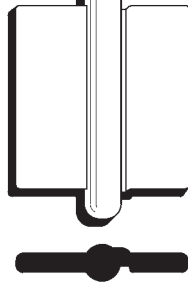
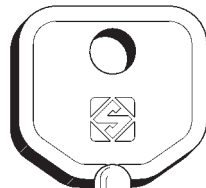

5AT7



5AT11AP

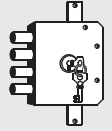

5

FOR/PER

ATRA (I)

AUNO (I)

+ ANTONIOLI (3-4)

FOR:
PER:

ATRA

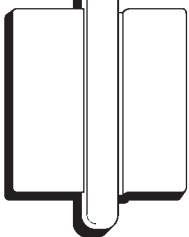
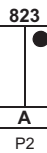
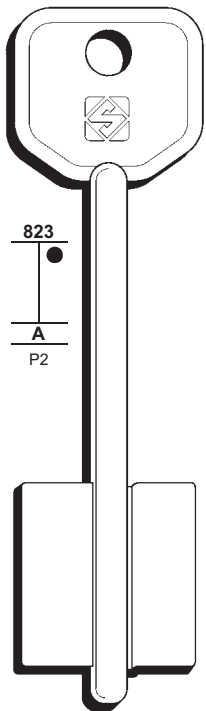

5AT1

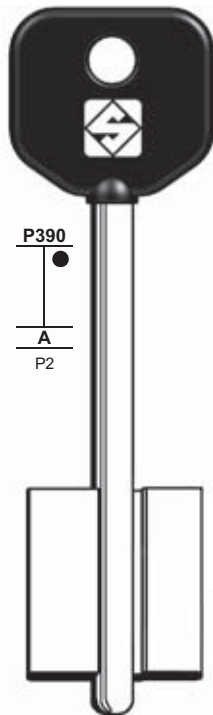

5AT1P

AUNO

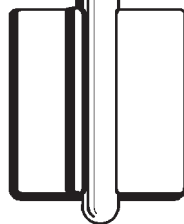
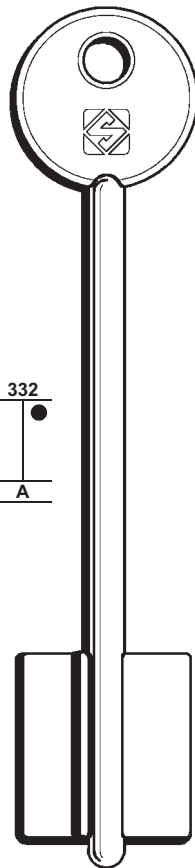

5AU9

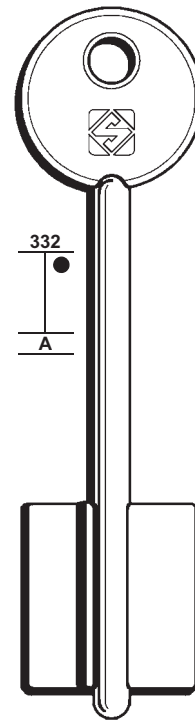

5AU11

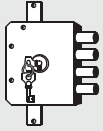

6

FOR/PER

AUNO (I)
+ ANTONIOLI (3-4)

AUTORI (I)
ISEO (35-36)

BETA (I)
POTENT

FOR: AUNO
PER:

1064
A

5AU13

FOR: BETA
PER:

498
A

BE2

P179
A

BE2P

POTENT

FOR: BETA
PER:

333
A

5BE3

333
A
P390

5BE5

333
A

BES

333
A

BE

333
A

BESC

333
A

BEC

FOR:
PER:

BETA

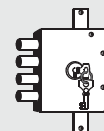

7

FOR/PER

BETA (I)

BLINKOR (I)
FACEF (27)

BMC (I)

BODA (FIN)

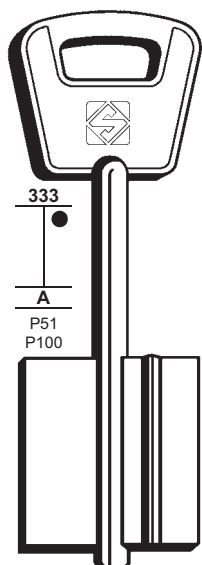

BEA



BEAC

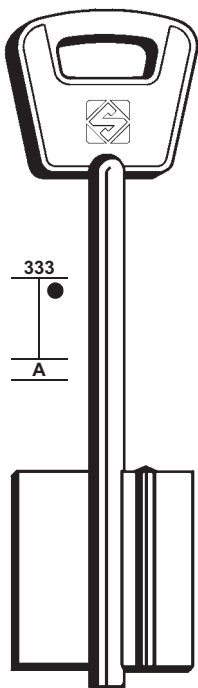

5BE2



5BE1

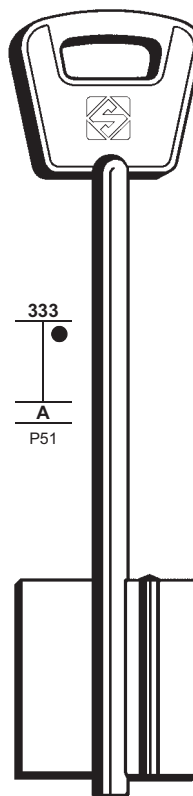

BEL



BELC

FOR:
PER:

BMC

BODA

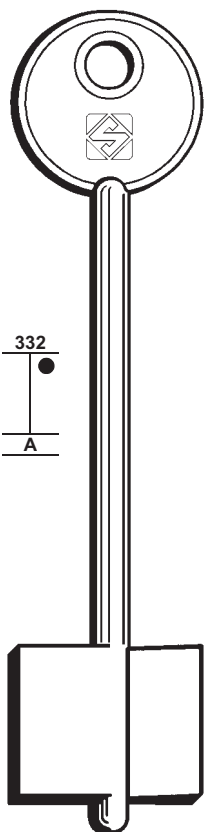

BL

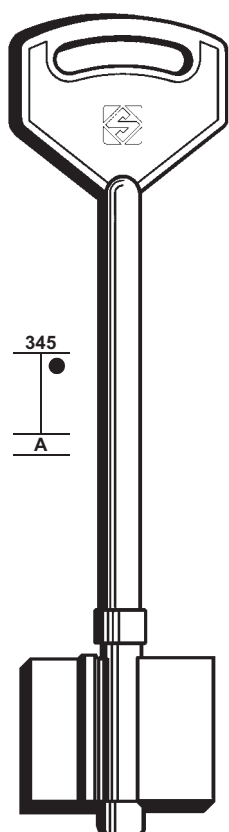

5BL1

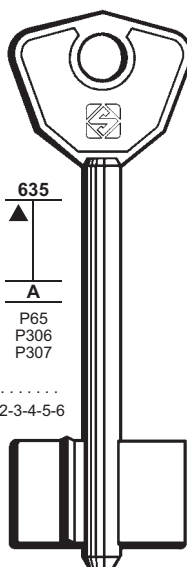

5BDA1
428

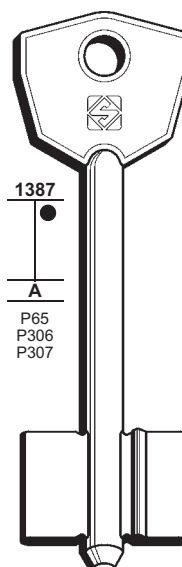

5BDA2

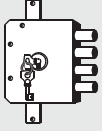

8

FOR/PER

BODA (FIN)

BODE (D)

+ (65-67)

FOR:

PER:

BODA

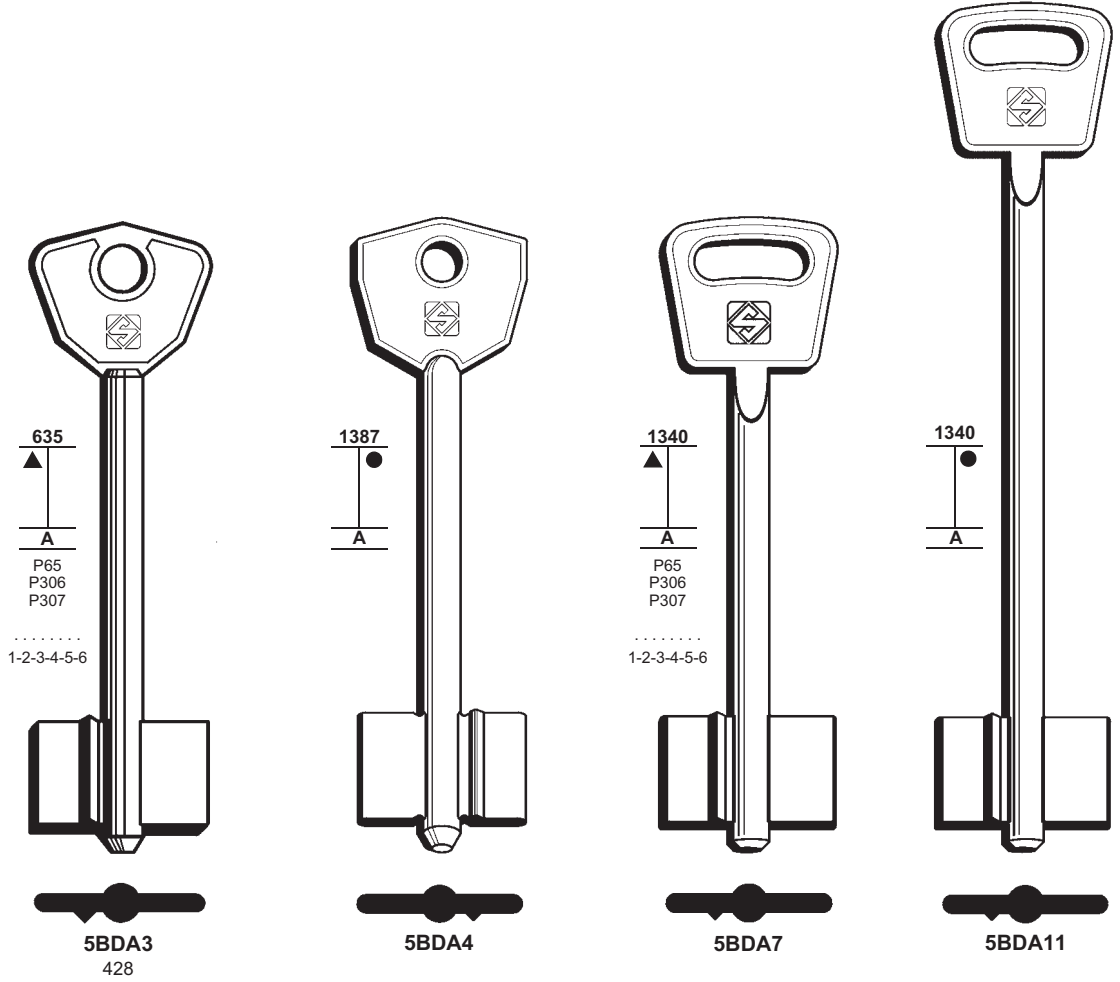

FOR:

PER:

BODE

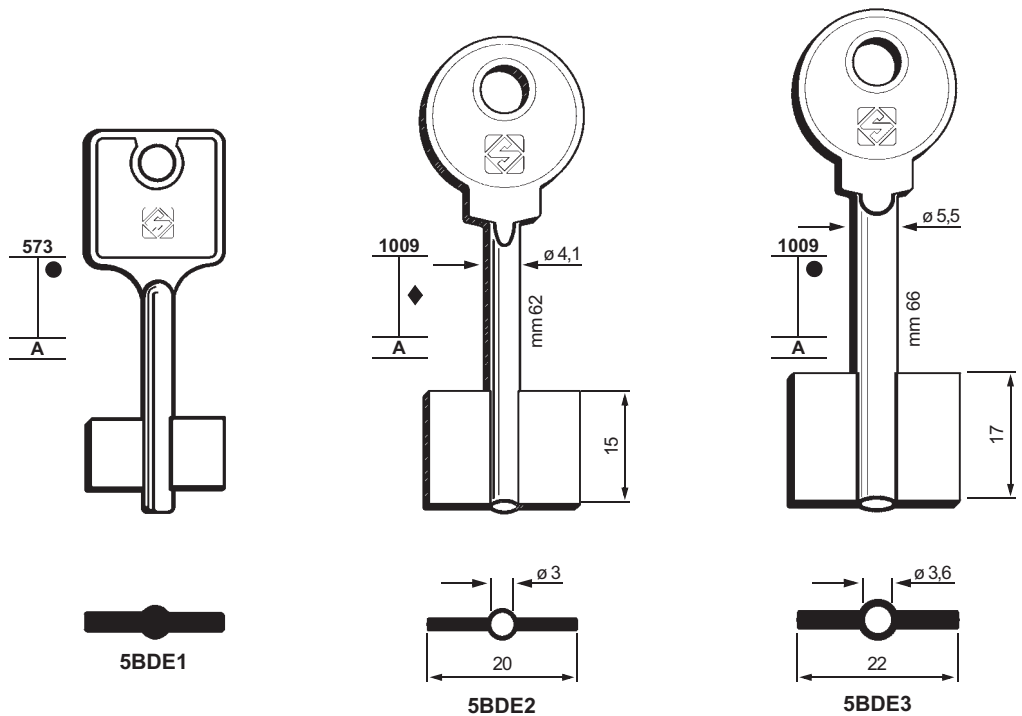

FOR:
PER:

BOGATIR

BURG-WÄCHTER

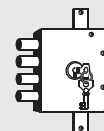
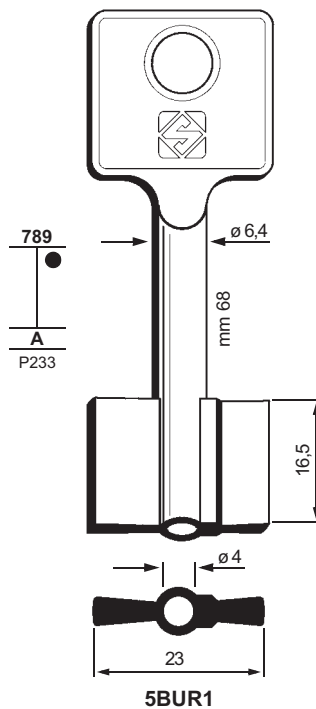
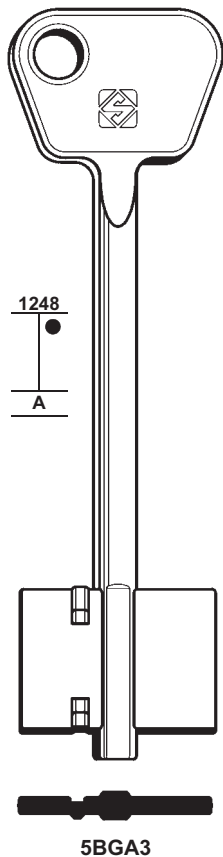
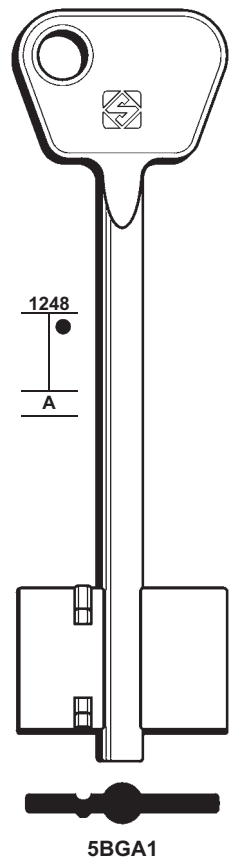

9

FOR/PER

BOGATIR (RUS)

BURG-WÄCHTER (D)

+ JEWEL (37)

CAF (I)

FOR:
PER:

BURG-WÄCHTER

CAF

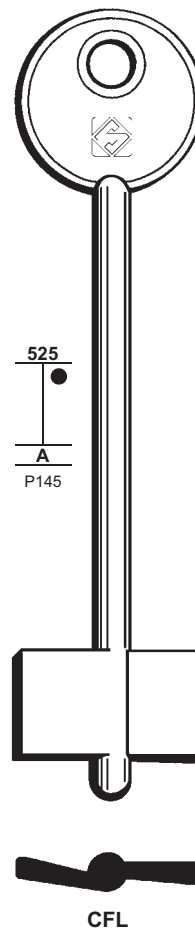
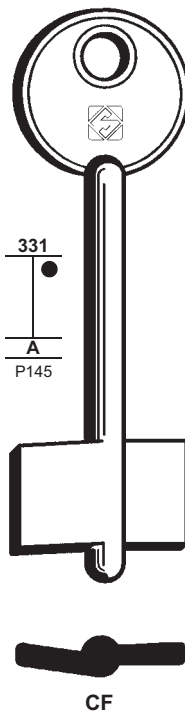
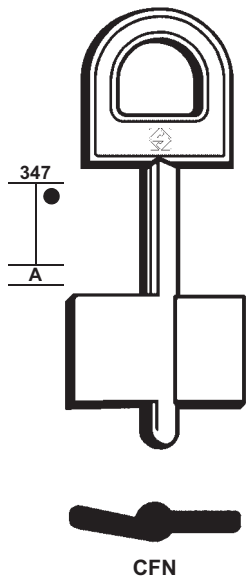
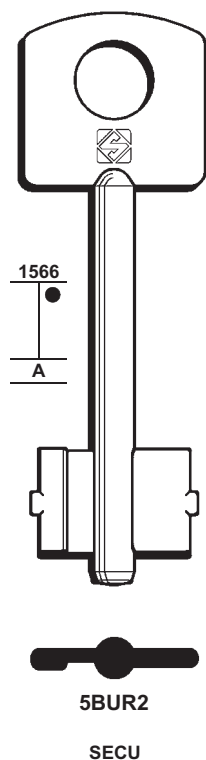

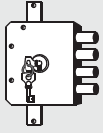

10

FOR/PER

CAM (RUS)

CECCHERELLI (I)

(69)

CENATA (RUS)

CERUTTI (I)

FOR:
PER:

CAM

CENATA

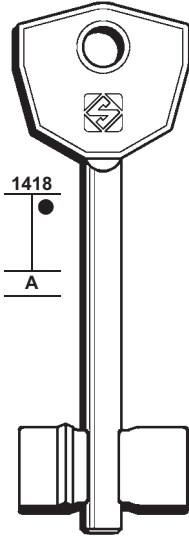

5SMA1

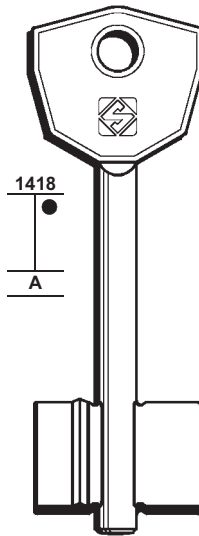

5ACM1

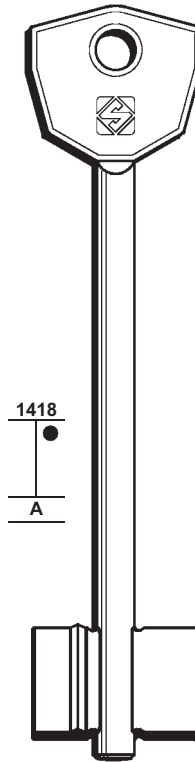

5ACM3

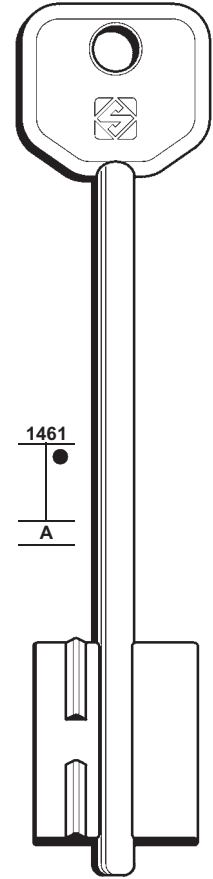

5CTA1

FOR:
PER:

CERUTTI

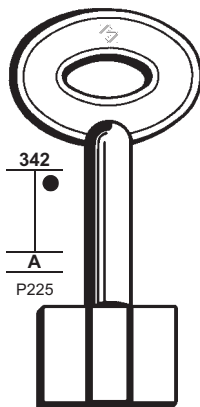

CPC

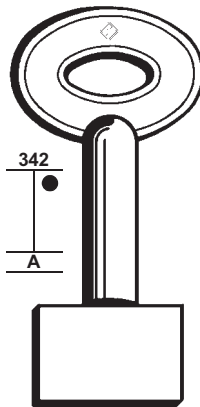

CPN

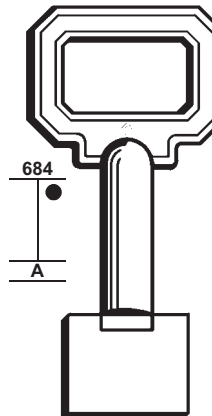

CPV

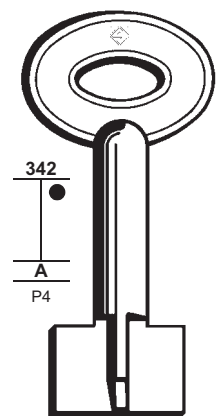

CPX

FOR:
PER:

CERUTTI

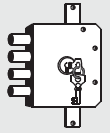

11

FOR/PER

CERUTTI (I)
CONFORTI
OSLA
VIRO

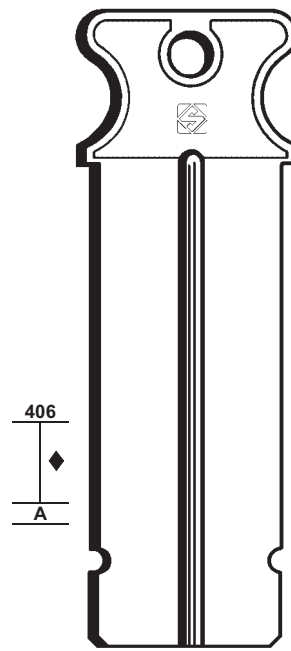
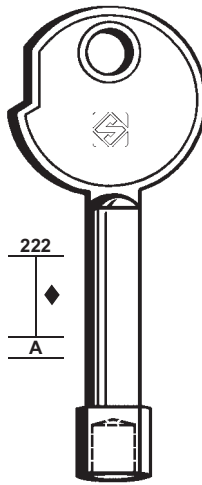
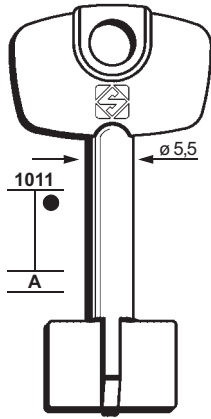
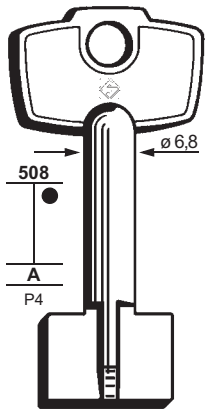

CPXN



5C15



CM



CPP

VIRO

FOR:
PER:

CERUTTI

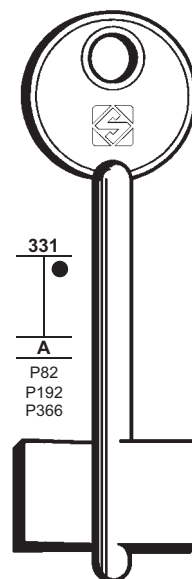
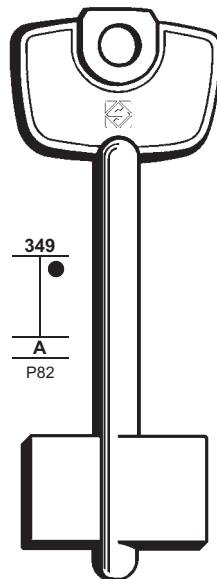
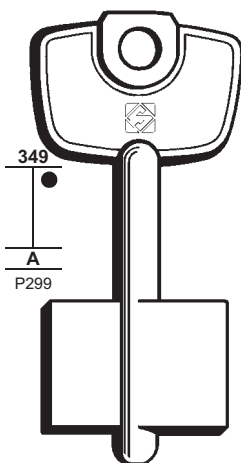
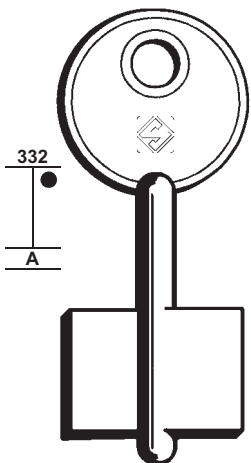

CCL



CCLQ



CQ



C



CC

CONFORTI - OSLA

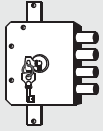

12

FOR/PER

CERUTTI (I)
CONFORTI
FEDELI
OSLA
VIRO

FOR:
PER:

CERUTTI

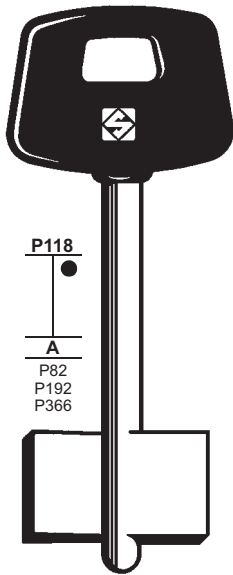

P118

A

P82
P192
P366

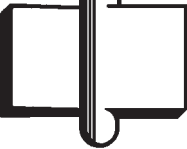

CP

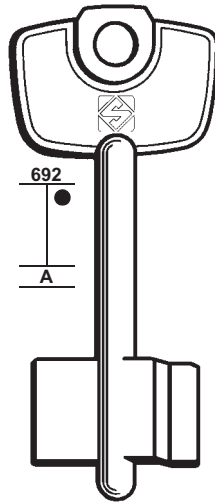

692

A

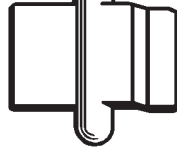

5C8

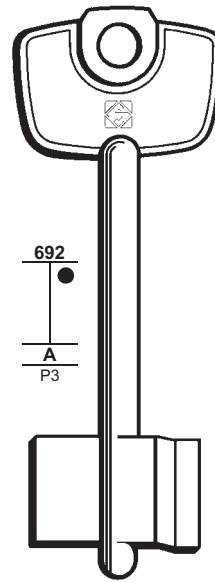

692

A

P3

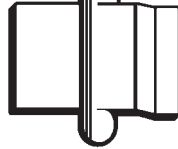

CN

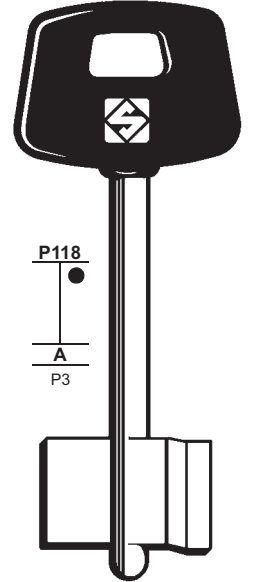

P118

A

P3

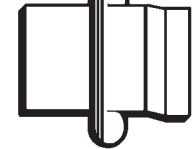

CNP

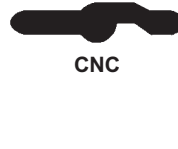

CNC



CNCP

CONFORTI - OSLA

VIRO

FOR:
PER:

CERUTTI

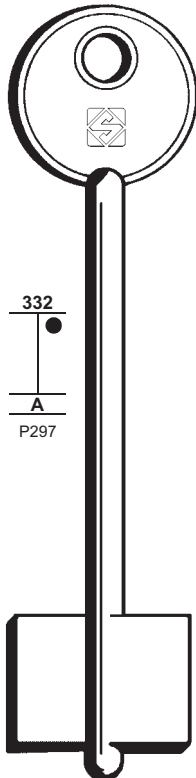

332

A

P297

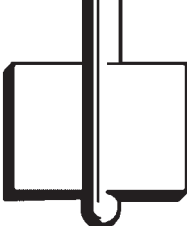

CLN

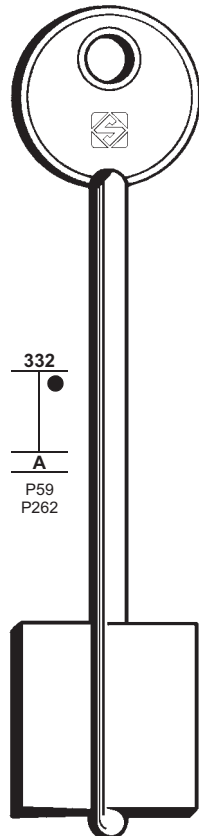

332

A

P59
P262

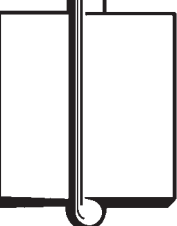

CL

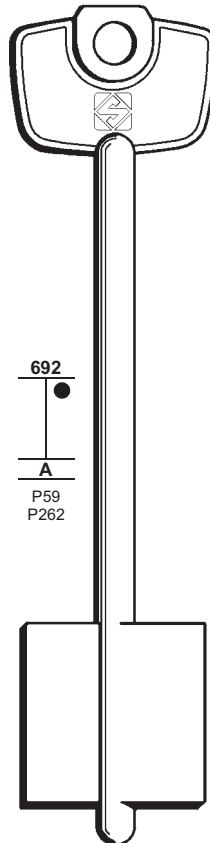

692

A

P59
P262



5C9

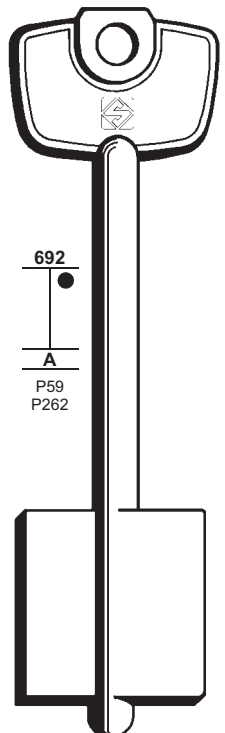

692

A

P59
P262

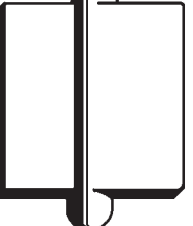

5C11

CONFORTI - FEDELI - VIRO

FOR:
PER:

CERUTTI

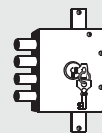

13

FOR/PER

CERUTTI (I)
FEDELI
VIRO

CIPIERRE (I)

CISA (I)

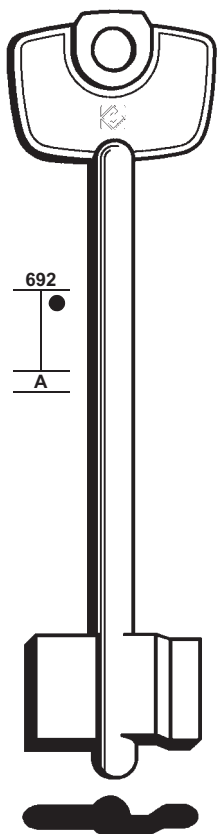

5C14
VIRO

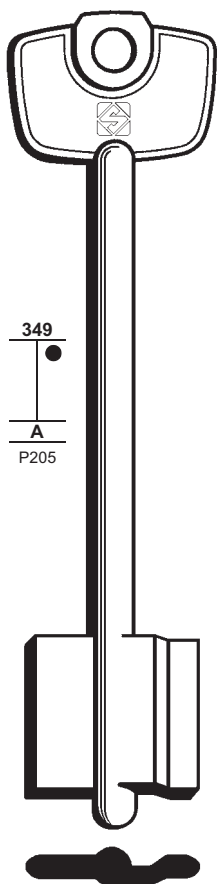

CLQ
FEDELI

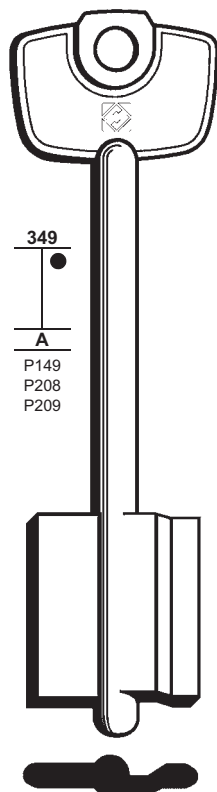

5C4
VIRO

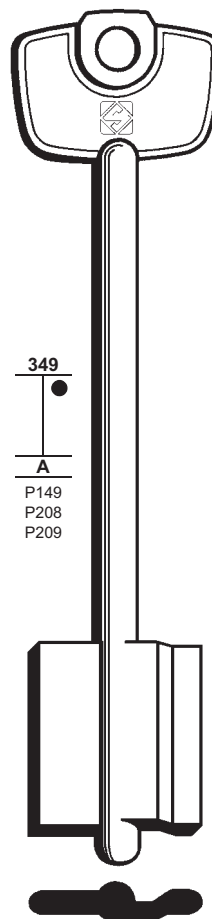

5C6

FOR:
PER:

CIPIERRE

CISA

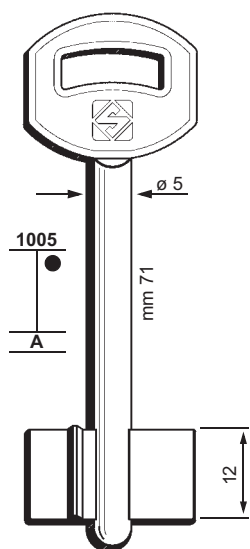

5CPR1

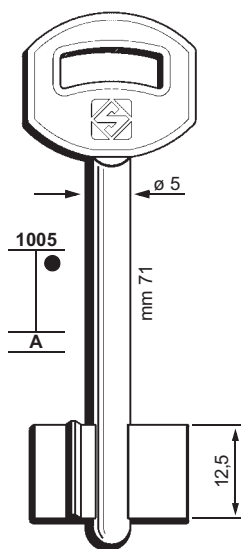

5CPR3

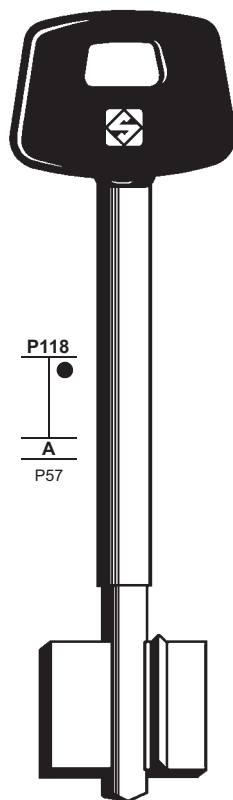

5CS8P

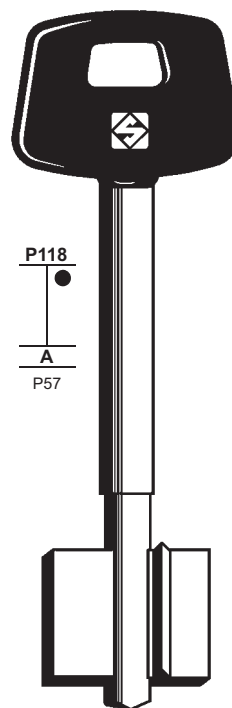

5CS6P

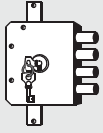

14

FOR/PER

CISA (I)
MCM
STAVER

FOR:
PER:

CISA

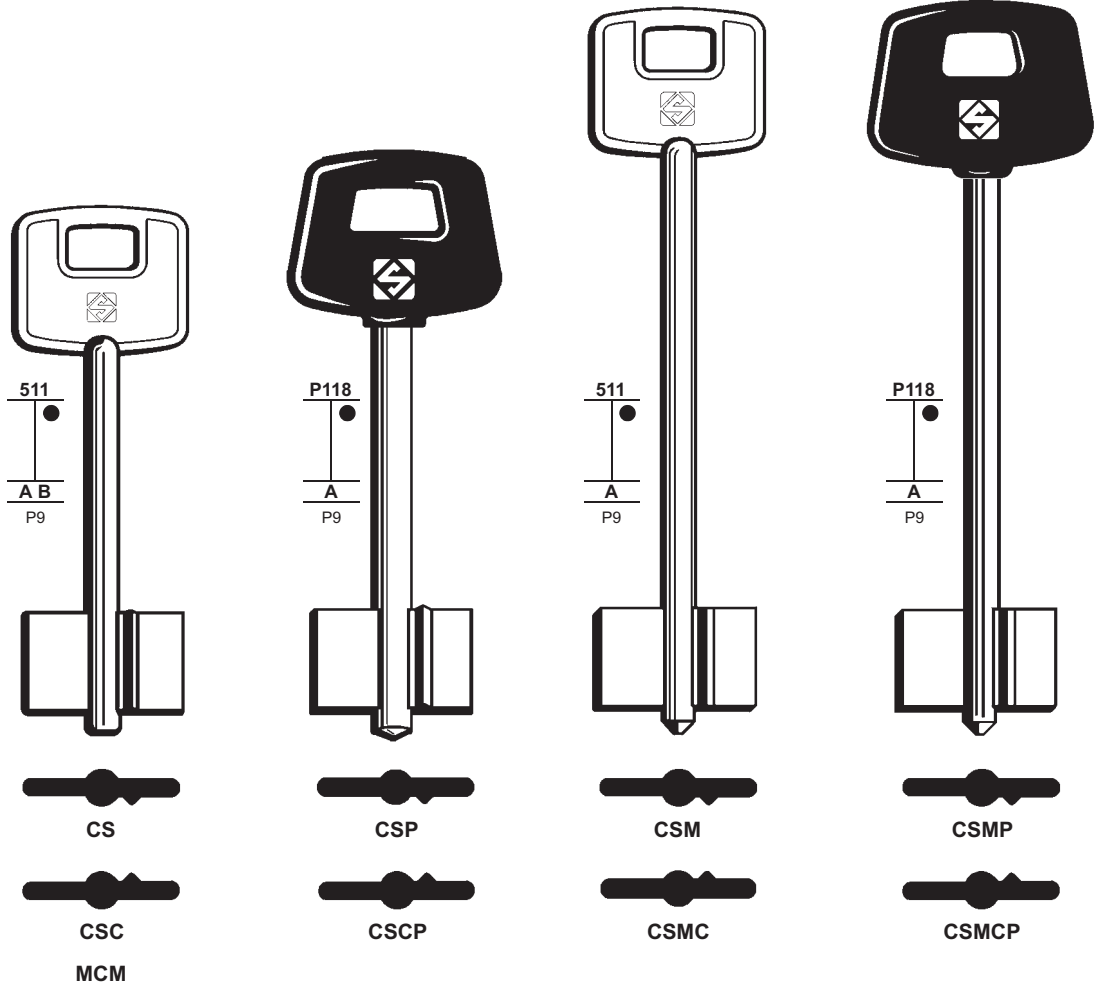

FOR:
PER:

CISA

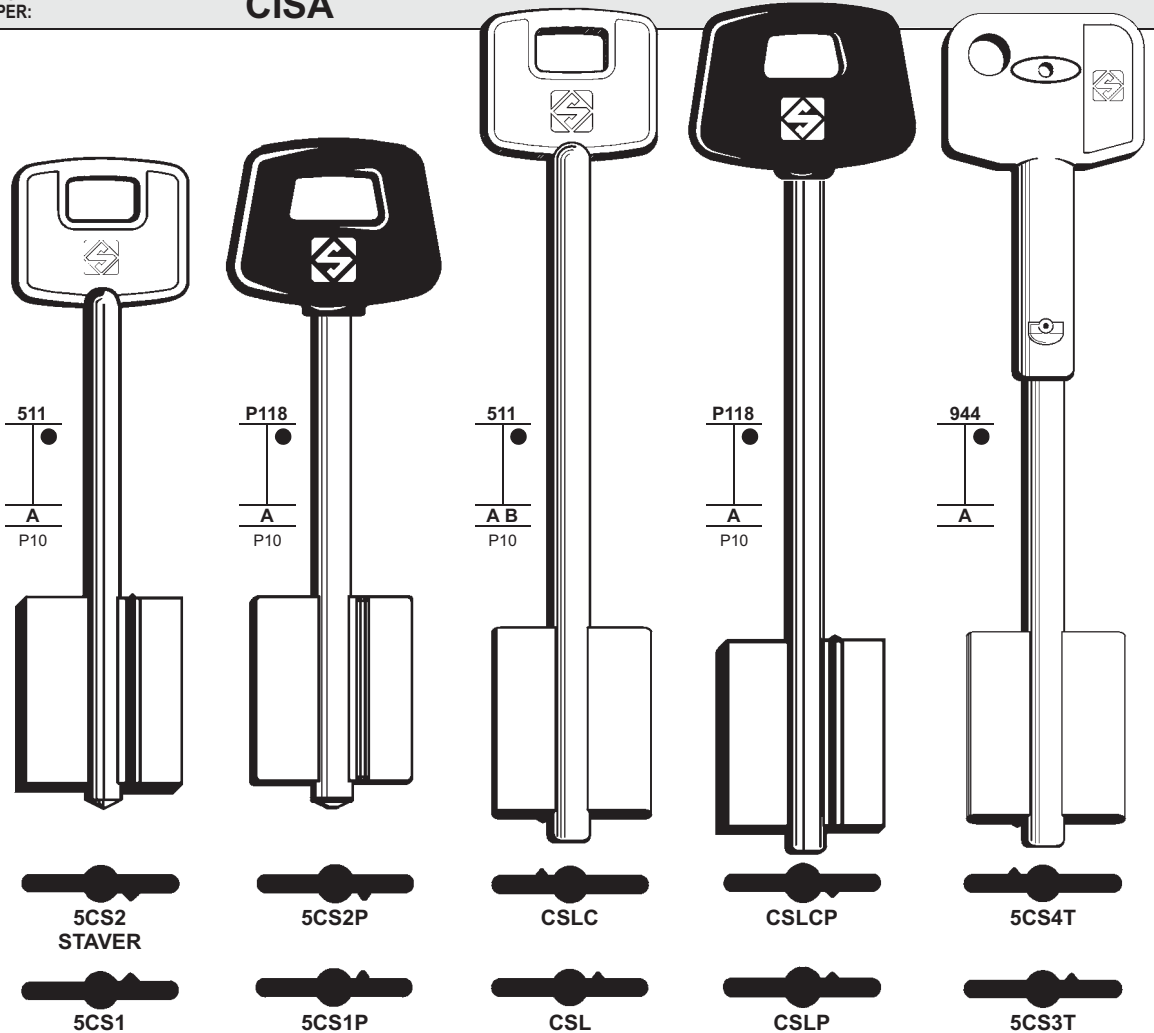

FOR:
PER:

CISA

CLASS

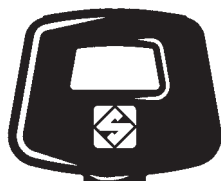

P118
A

P118
A
P253

1225
A

1225
A

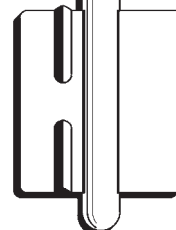
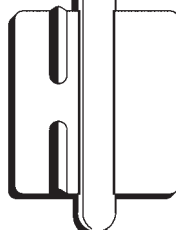
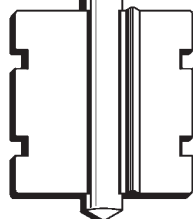
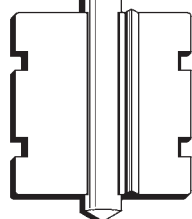

5CS12P

5CS10P

5CSS3

5CSS1

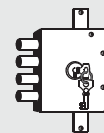

15

FOR/PER

CISA (I)

CLASS (RUS)

CONFORTI (I)

+ CERUTTI (11-12)

+ SIDERAL (56)

+ (71-72-73)

FOR:
PER:

CONFORTI

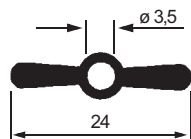
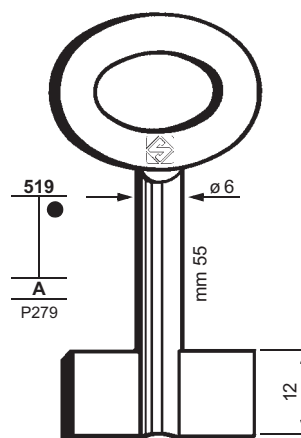
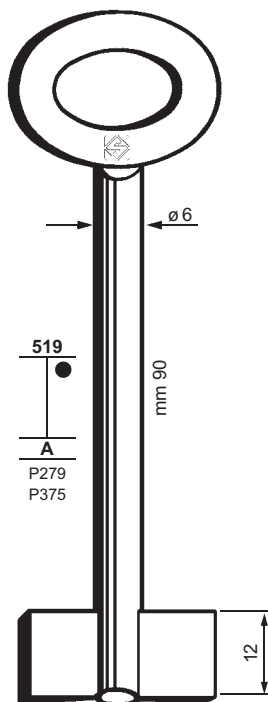
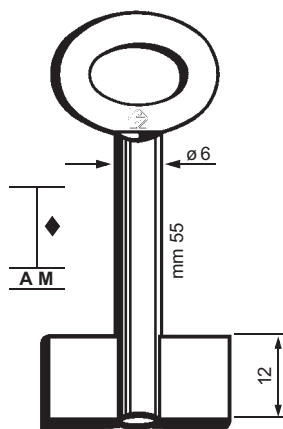

8405

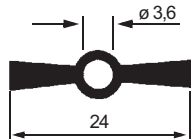

8388C

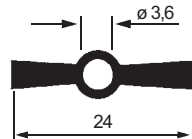

8355C

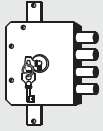

16

FOR/PER

CONFORTI (I)

- + CERUTTI (11-12)
- + SIDERAL (56)
- + (71-72-73)

CORBIN (I)

- + (76)

CORNI (I)

- GRODNO
- LINCE
- + SECUREMME (53)

FOR:
PER:

CONFORTI

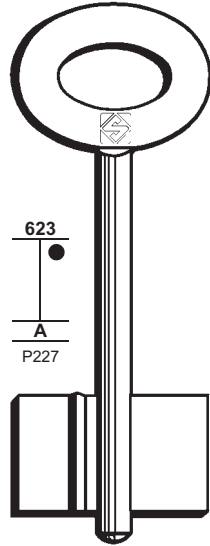

5CT1

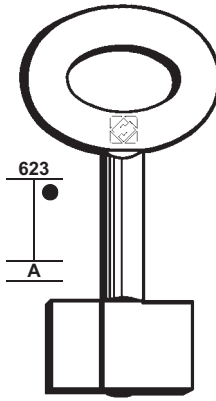

5CT3

CORBIN

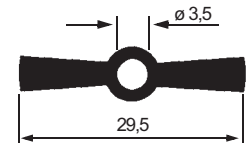
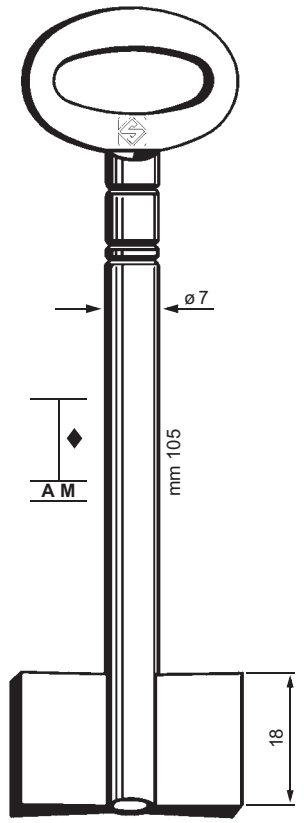

8711

FOR:
PER:

CORBIN

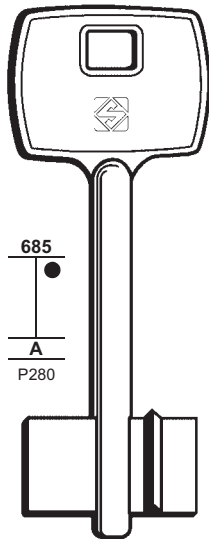

5CB2

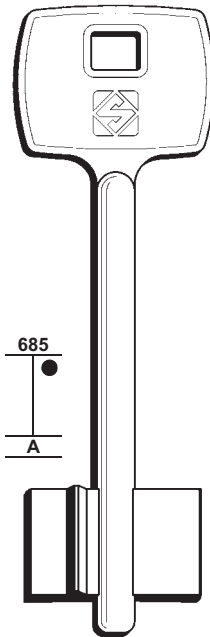

5CB3

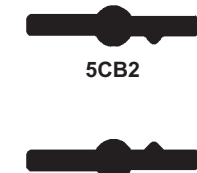

5CB1

CORNI

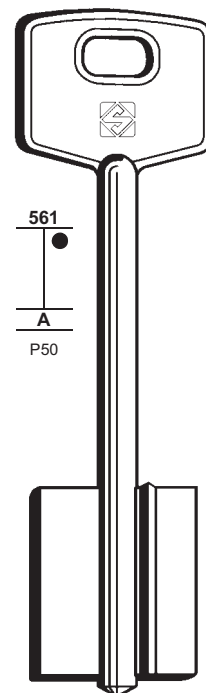

5CC4

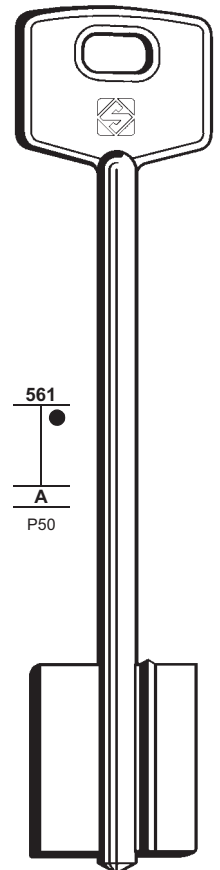

5CC2
LINCE GRODNO

FOR:
PER:

C.R.

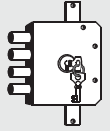

17

FOR/PER

C.R. (I)

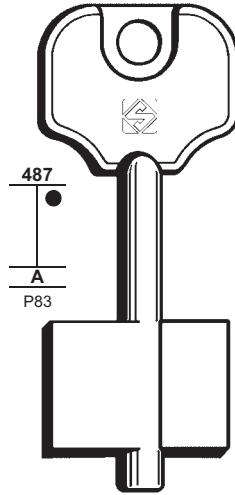
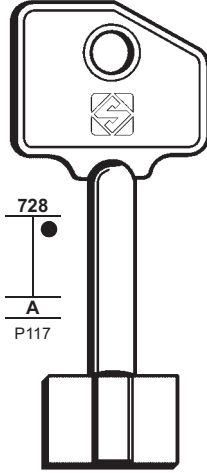
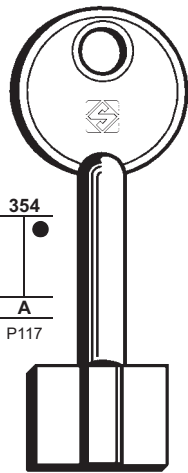
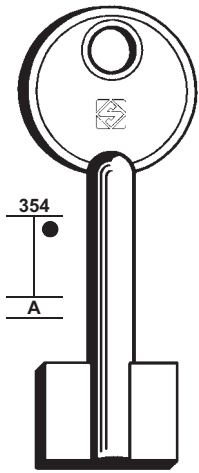

RP



RPC



5R7



RN

FOR:
PER:

C.R.

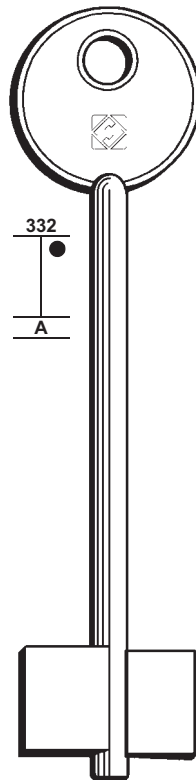
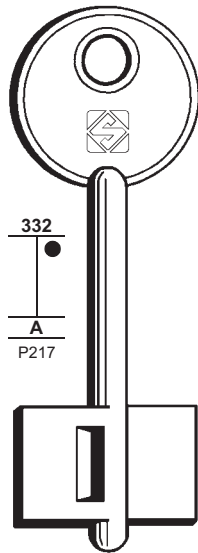
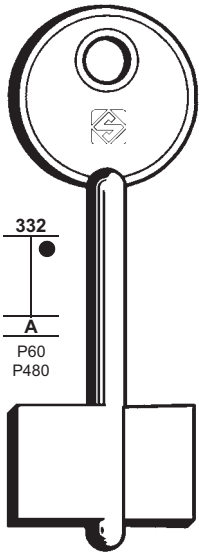

R



5R2



RF



RFO



RM

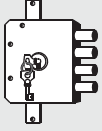

18

FOR/PER
C.R. (I)

FOR:
PER:

C.R.

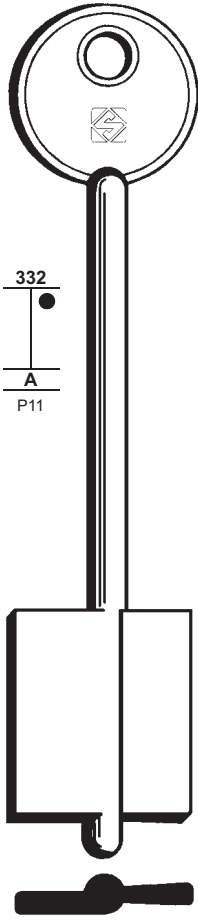

RL

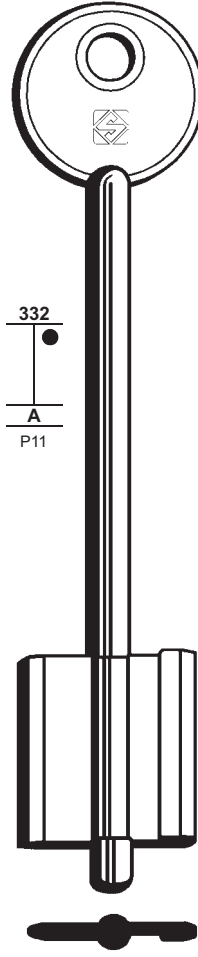

RLN

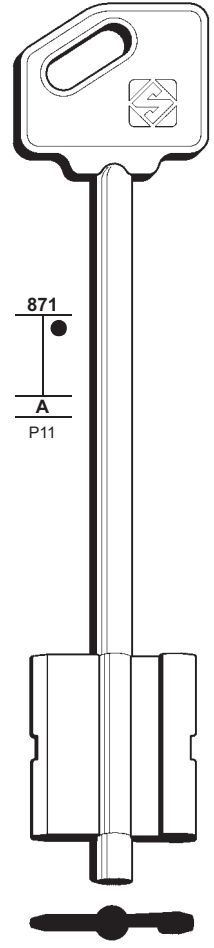

5R16

FOR:
PER:

C.R.

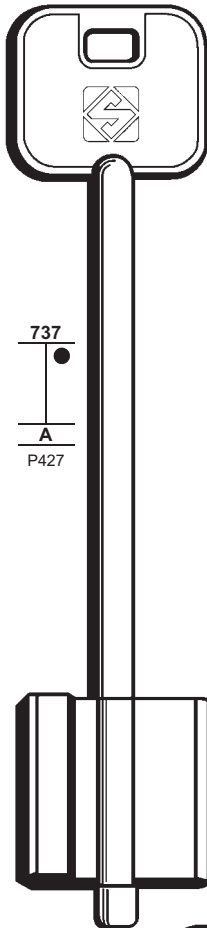

5R9

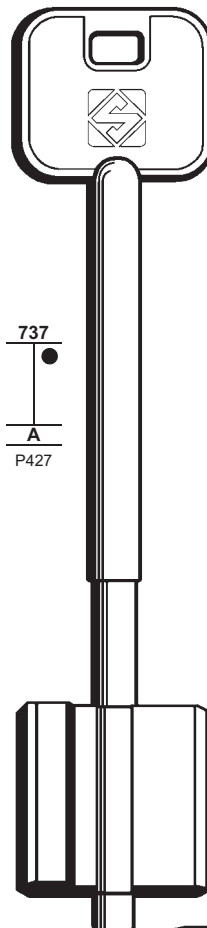

5R11

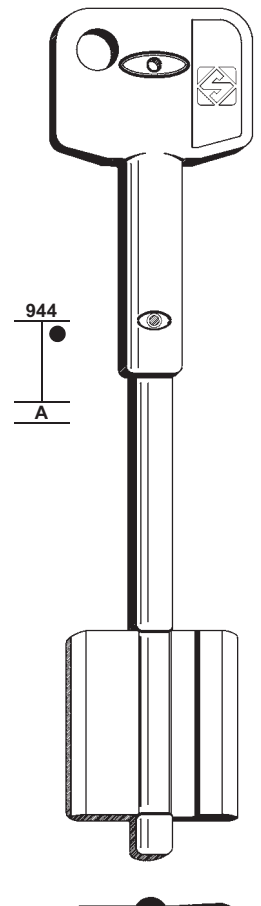

5R12T

FOR:
PER:

C.R.

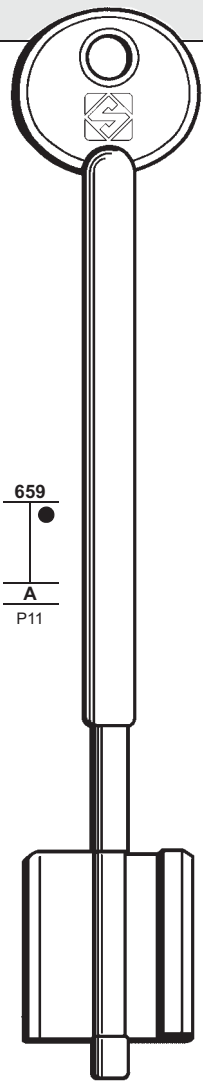

659
A
P11



5R6

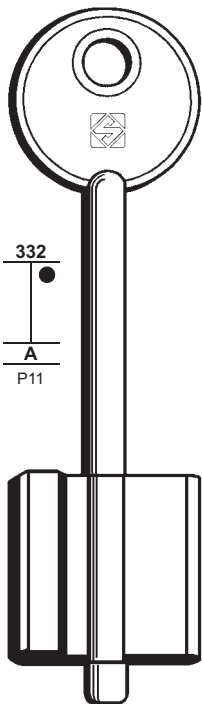

332
A
P11



RLCR



RLC

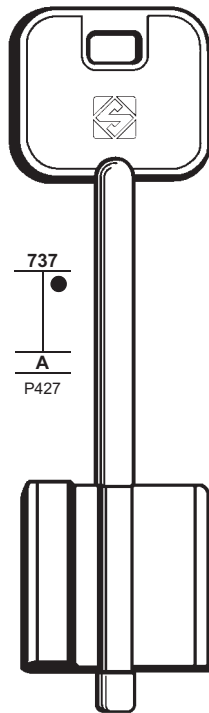

737
A
P427



5R3

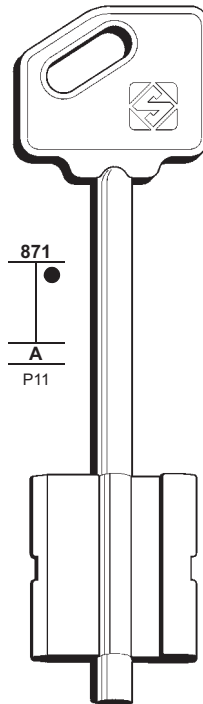

871
A
P11



5R14

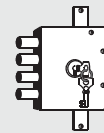

19

FOR/PER

C.R. (I)

DEKABA (BG)
MAUER

DENY (F)

DOMUS (I)
FACEF (27)

DUTO (I)
(77-78)

DUPLEX (RUS)

FOR:
PER:

DEKABA

DENY

DUPLEX

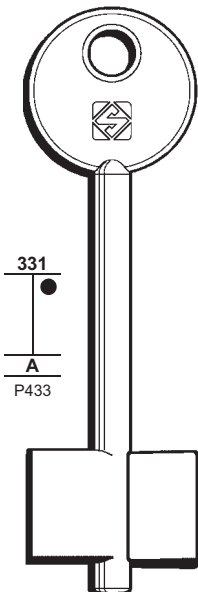

331
A
P433



5DK1
MAUER

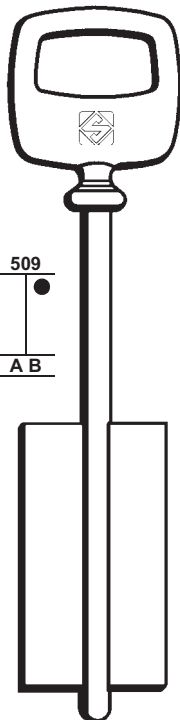

509
A B



5DY1

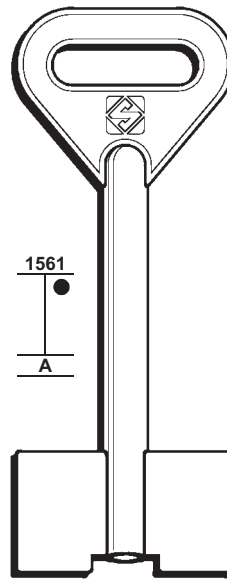

1561
A



5DUX2

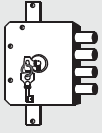

20

FOR/PER
DVERNIAK (RUS)

FOR:
PER:

DVERNIAK

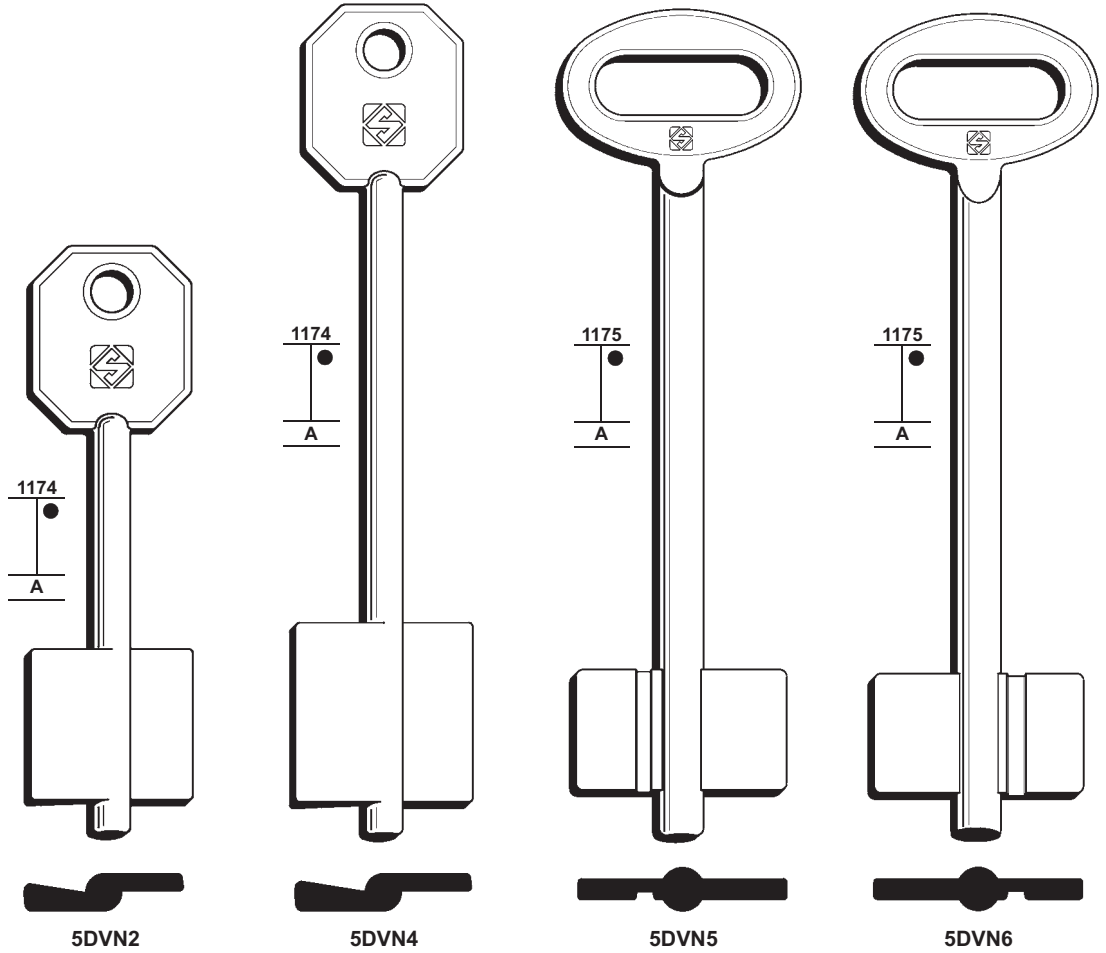

FOR:
PER:

DVERNIAK

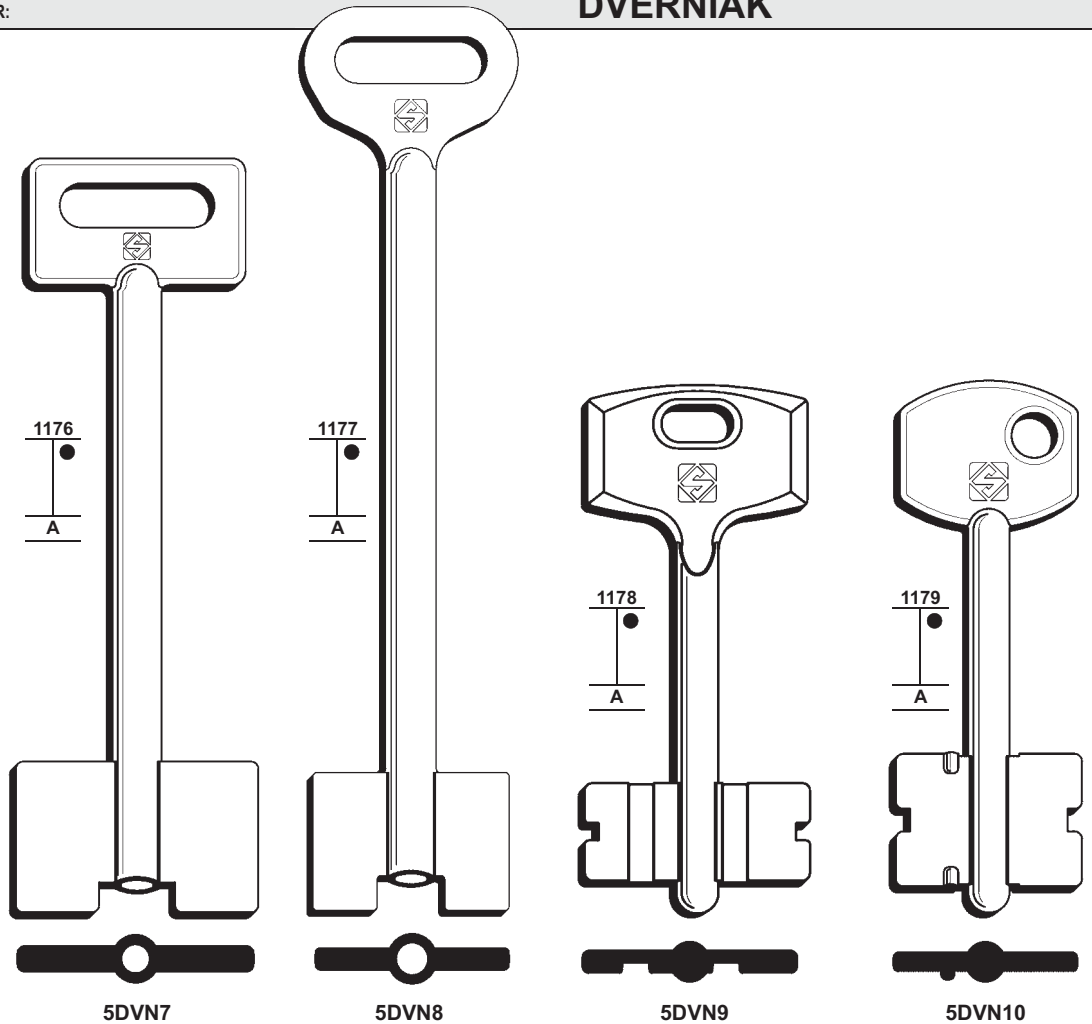

FOR:
PER:

DVERNIAK

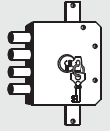

21

FOR/PER

DVERNIAK (RUS)

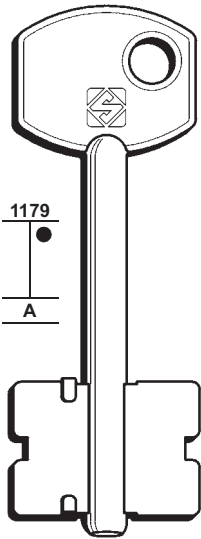

5DVN10F

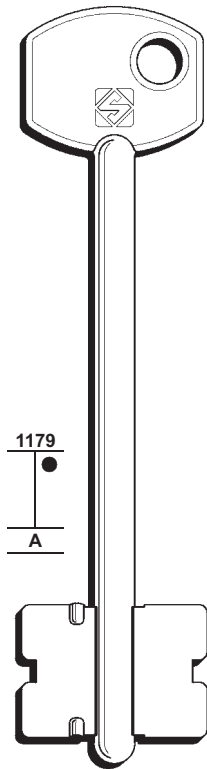

5DVN12

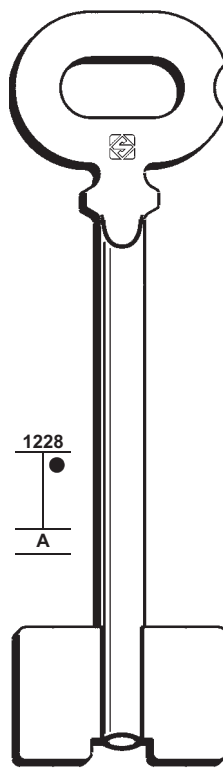

5DVN15

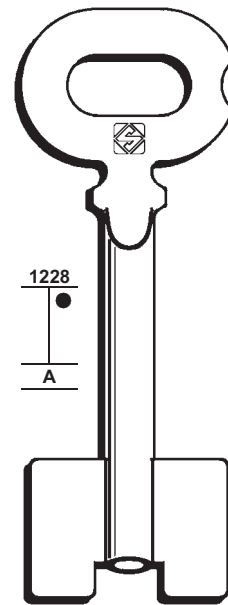

5DVN14



FOR:
PER:

DVERNIAK

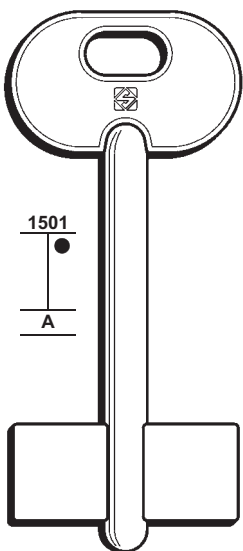

5DVN22

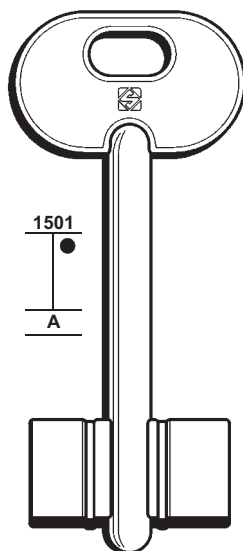

5DVN23

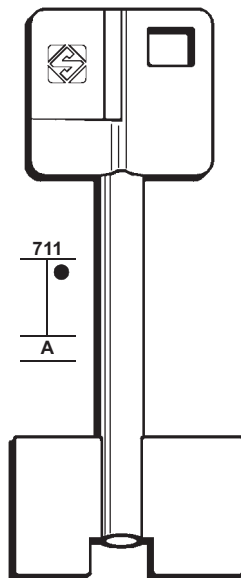

5DVN24

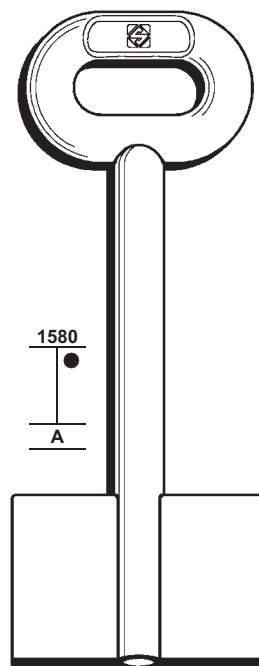

5DVN25

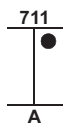
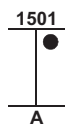
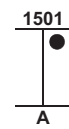

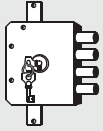

22

FOR/PER

DVERNIAK (RUS)

ELZETT (H)

+ 👁️ (70)

FOR:

PER:

DVERNIAK

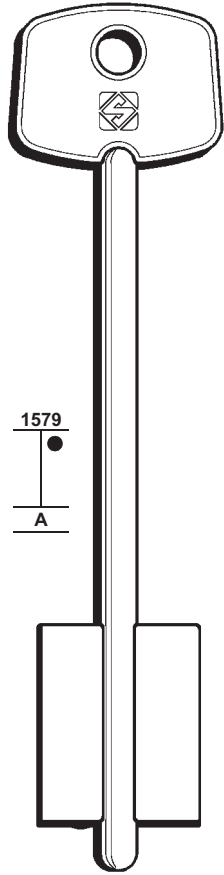

5DVN26

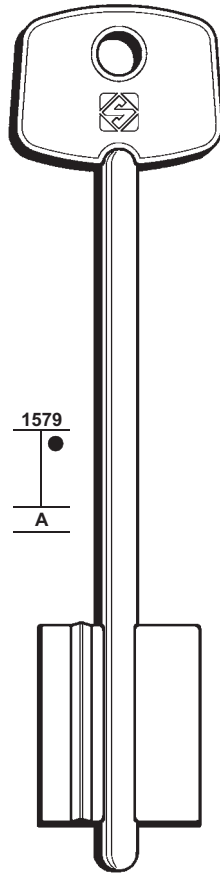

5DVN27

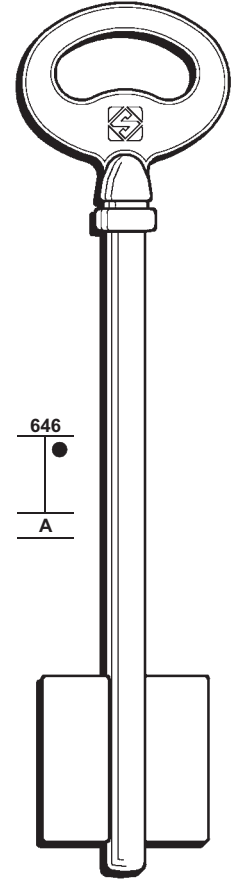

5DVN34

FOR:
PER:

DVERNIAK

ELZETT

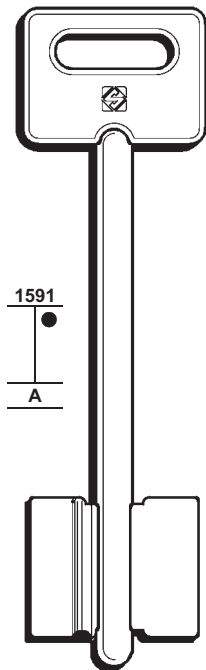

5DVN29

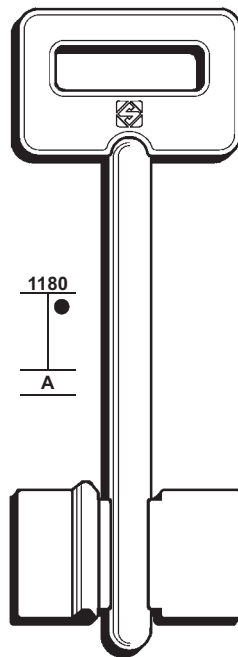

5DVN31

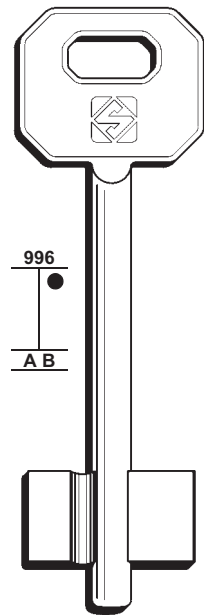

5EL1

FOR:
PER:

ELZETT

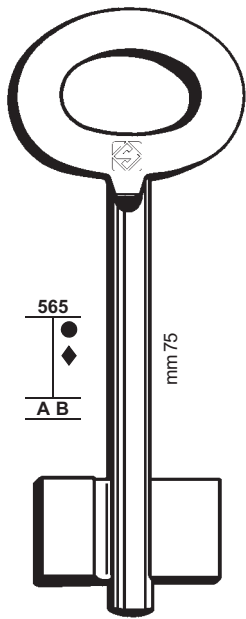

565
A B
mm 7,5



7308E

ELBOR

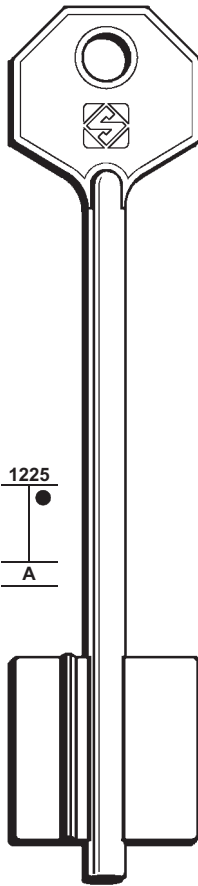

1225
A



5DVN19

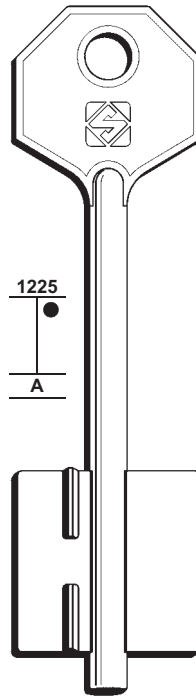

1225
A



5DVN17

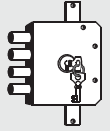

23

FOR/PER

ELZETT (H)
+ (70)

ELBOR (RUS)

EMME (I)
SECUREMME (53)

FOR:
PER:

ELBOR

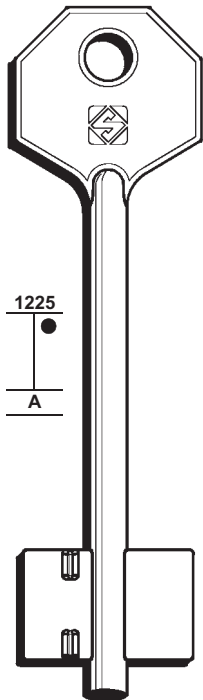

1225
A



5EB2

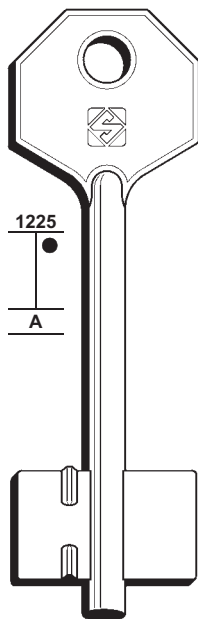

1225
A



5DVN21

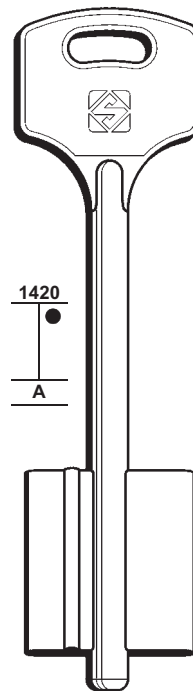

1420
A



5EB1

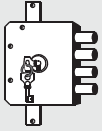

24

FOR/PER

EREVAN (AZ)

ESETY (I)
TESIO

FOR:
PER:

EREVAN

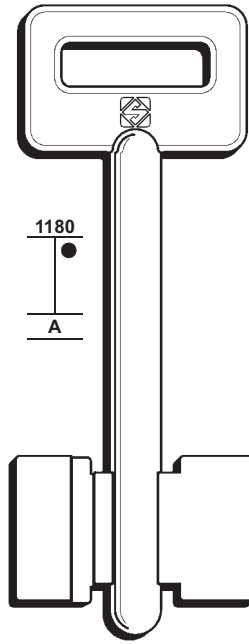

1180
A



5ERV1

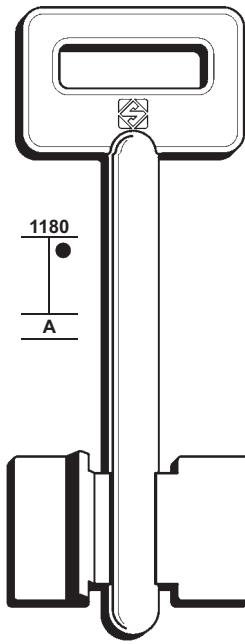

1180
A



5ERV3

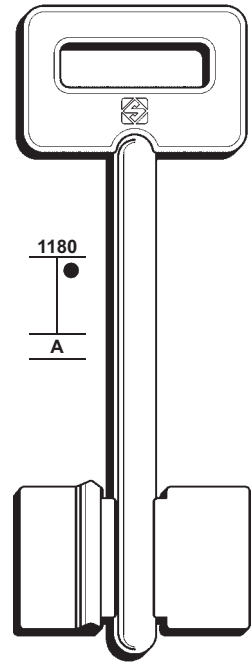

1180
A



5ERV5

FOR:
PER:

ESETY

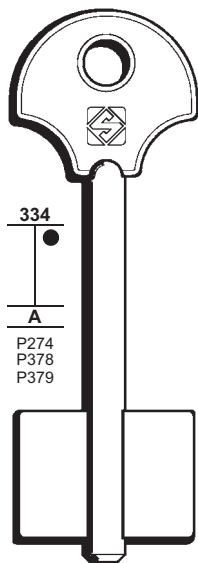

334
A
P274
P378
P379



E

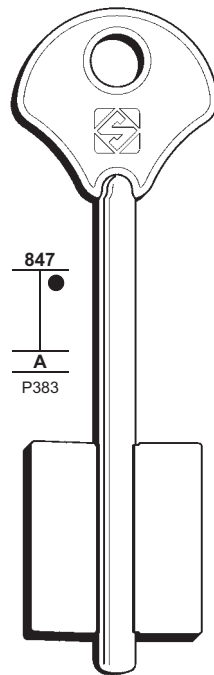

847
A
P383



EN

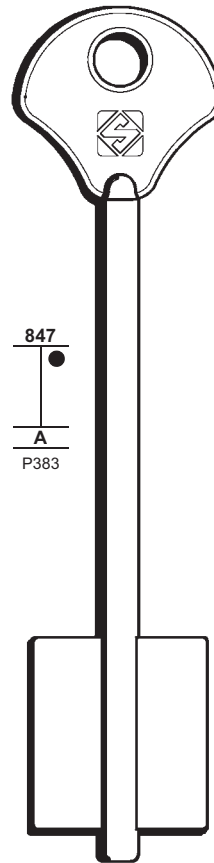

847
A
P383



EL

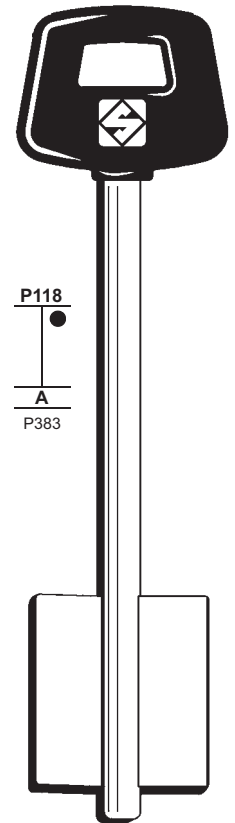

P118
A
P383



ELP

TESIO

FOR:
PER:

ESETY

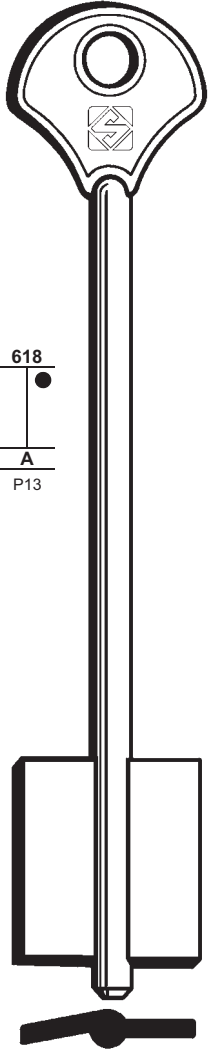

5EY1

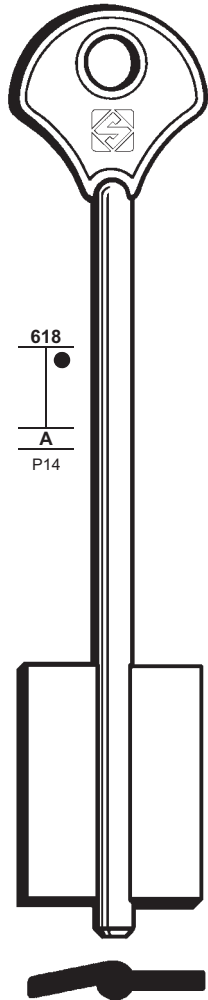

5EY3
ISMET

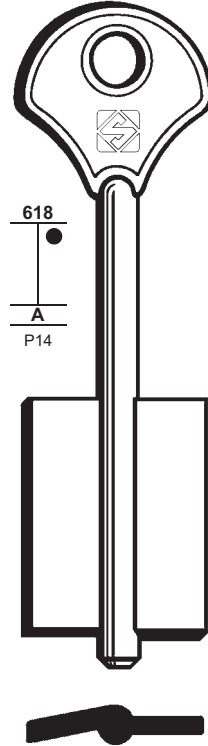

5EY5

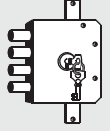

25

FOR/PER

ESETY (I)
ISMET

FOR:
PER:

ESETY

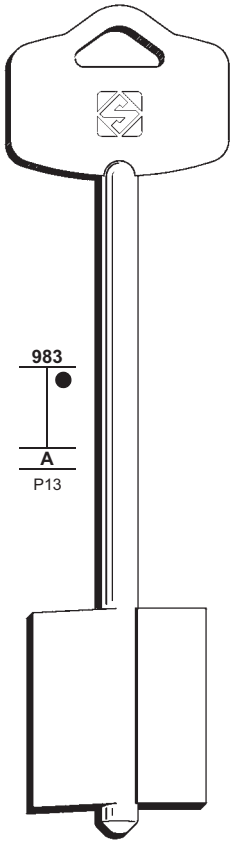

5EY22

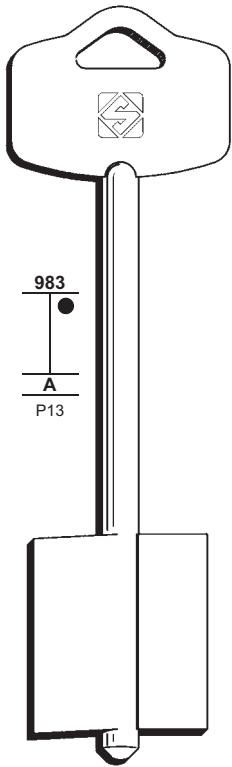

5EY24

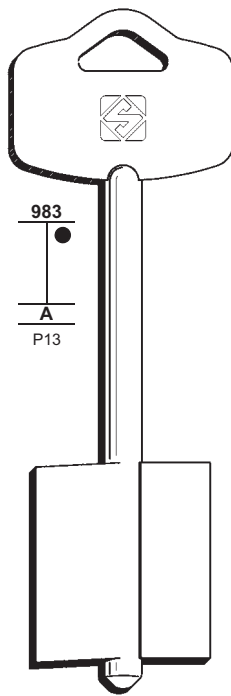

5EY20

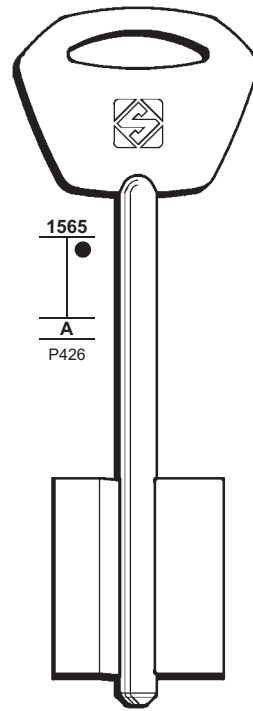

5EY32

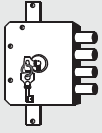

26

FOR/PER

ESETY (I)

ET (I)

⊗ POTENT (49)

EZCURRA (E)

FOR:
PER:

ESETY

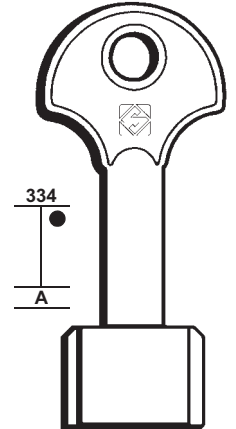
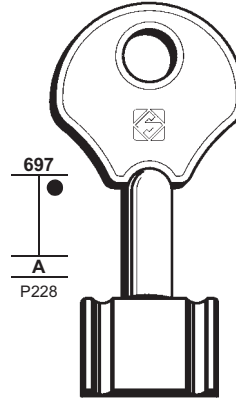
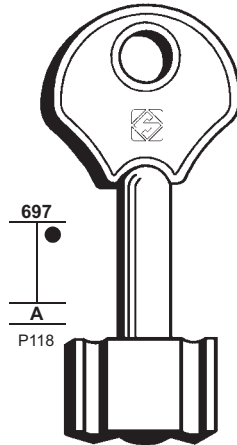
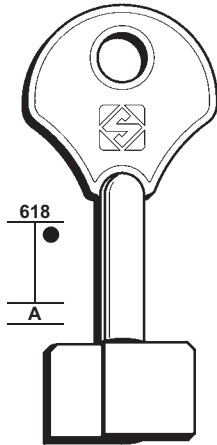

FOR:
PER:

EZCURRA

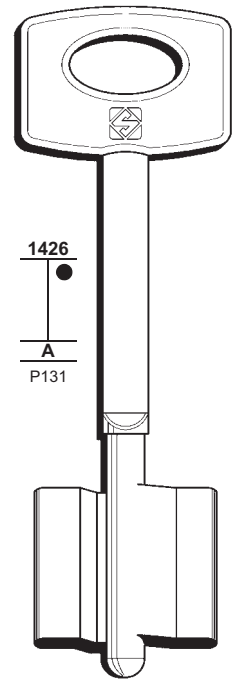
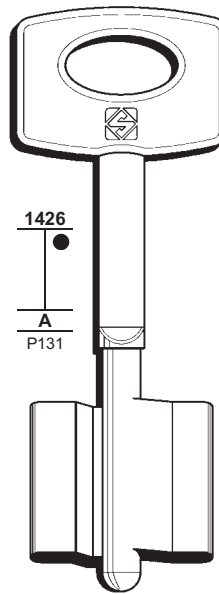
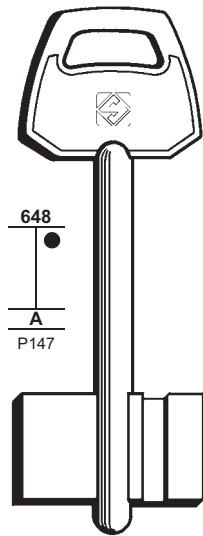

FOR:
PER:

FAC

FACEF - DOMUS

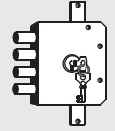

27

FOR/PER

FAC (E)

FACEF (I)
BLINKOR
DOMUS
GUARDIAN

FASEM (I)

👁️ IDM (34-35)

FASTA (I)

+ 👁️ (67)

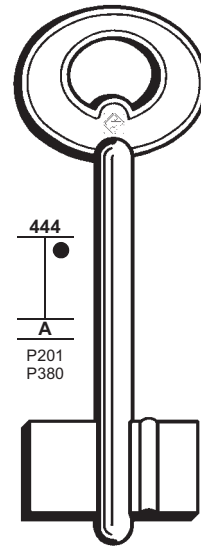
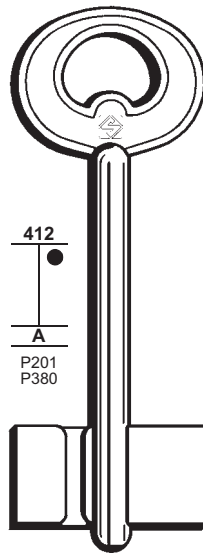
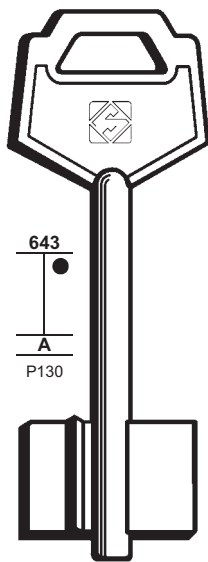
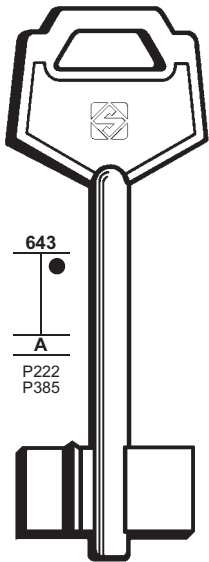

5FAC1



5FAC3



DS



FD

BLINKOR - DOMUS - GUARDIAN

FOR:
PER:

FASTA

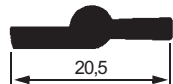
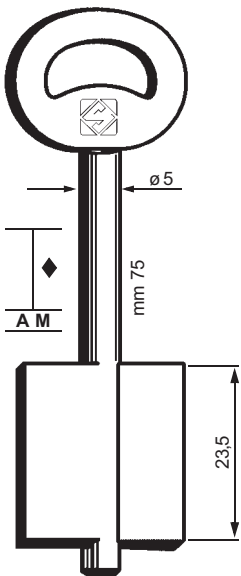

7150

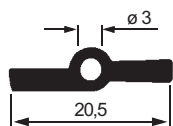
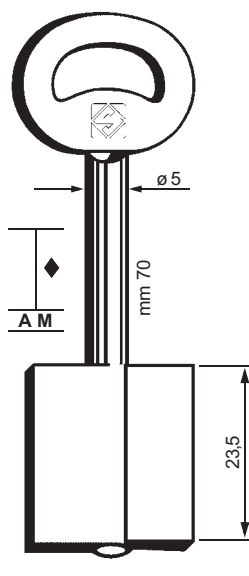

8150

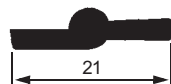
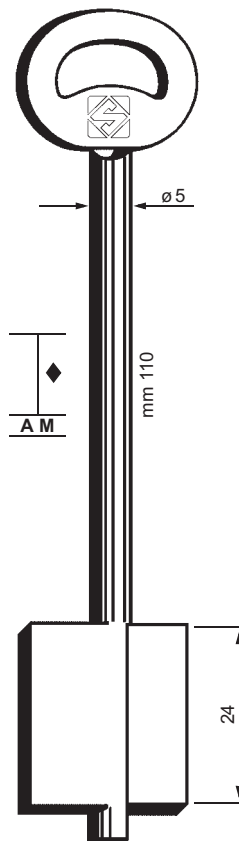

7151

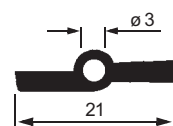
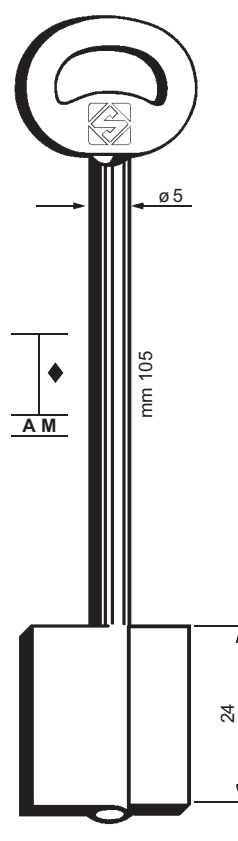

8151

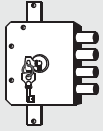

28

FOR/PER

FEB (I)
VIRO (I)
YALE

FEDELI (I)

CERUTTI (12-13)
MOTTURA (42)

FERRAMETALL (I)

FETIS (E)

FIAM (I)

+ IDM (35)

FOR:
PER:

FEB

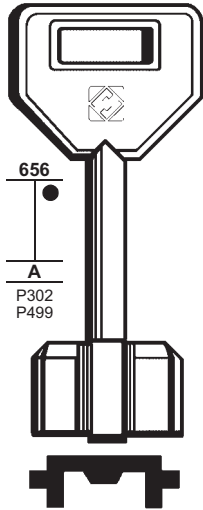

5FEB5
VIRO - YALE

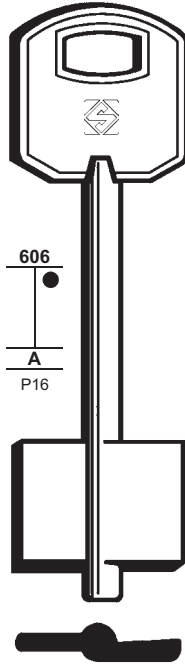

5FEB1

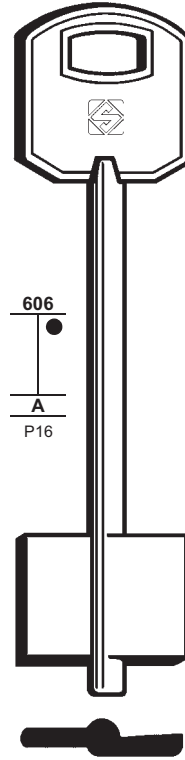

5FEB7

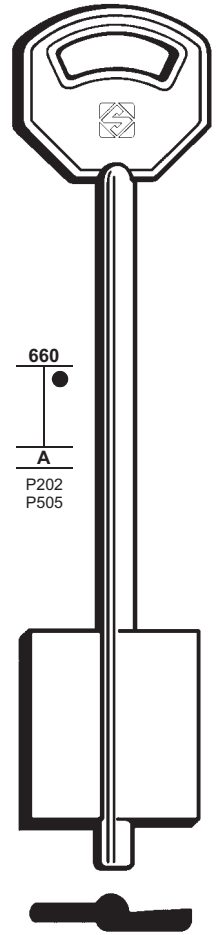

5FEB3
VIRO

FOR:
PER:

FERRAMETALL

FETIS

FIAM

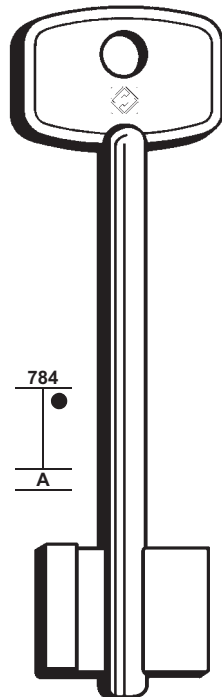

5FR1

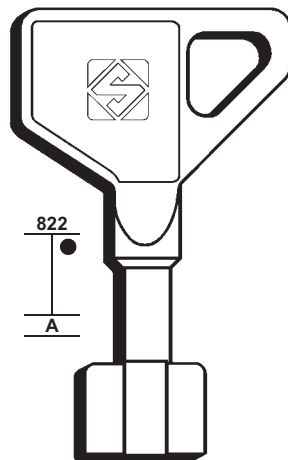

5FE1

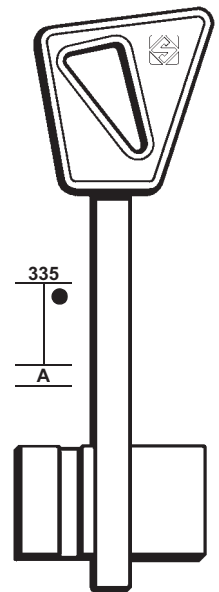

FQ

FOR:
PER:

FIAM

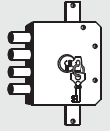

29

FOR/PER

FIAM (1)
+ IDM (34)

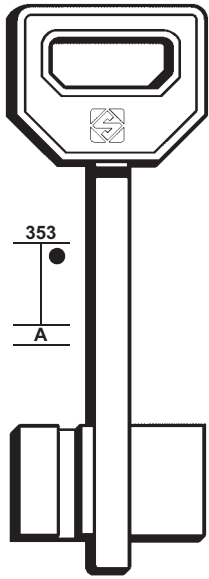

FQN

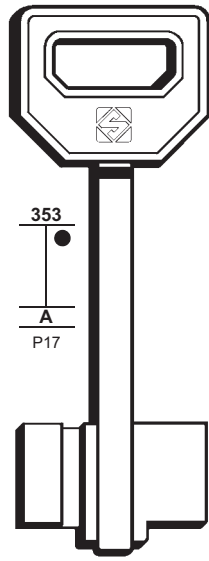

5F15

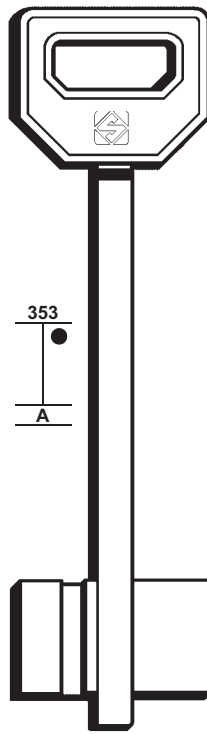

FQC

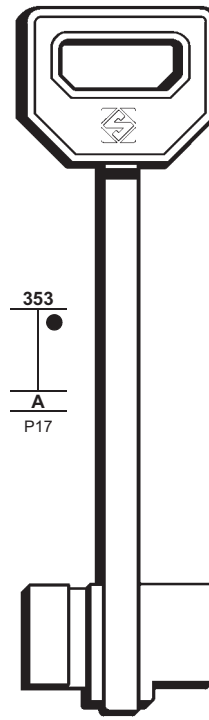

5F17

FOR:
PER:

FIAM

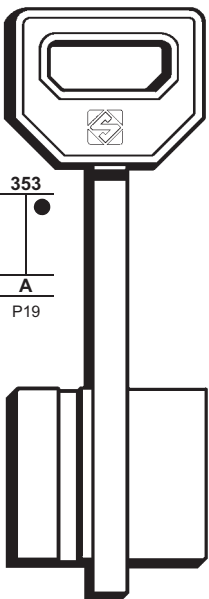

5F13

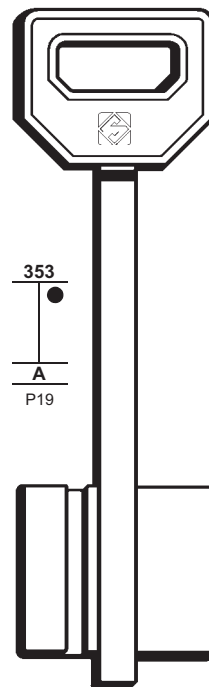

FQM

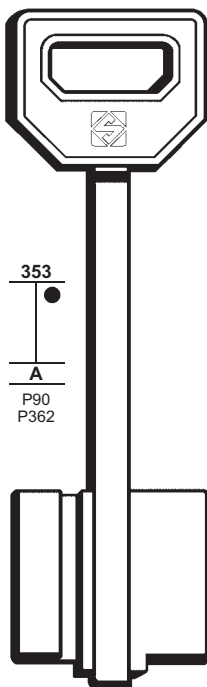

5F19

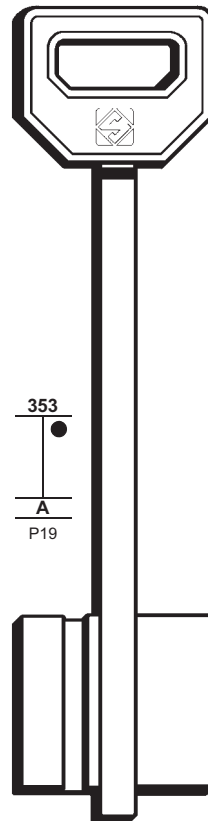

FQL

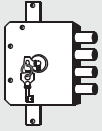

30

FOR/PER

FIAM (I)

+ IDM (34)

FOR:

PER:

FIAM

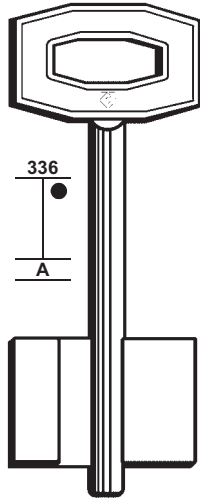

5F11

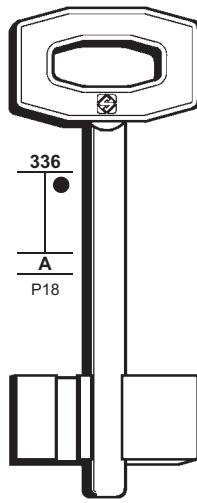

F

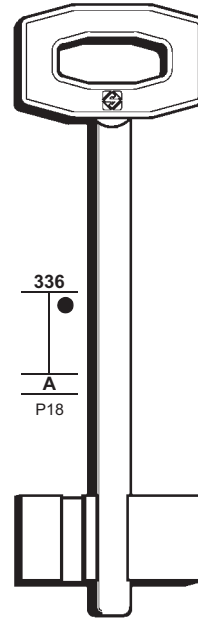

FTN

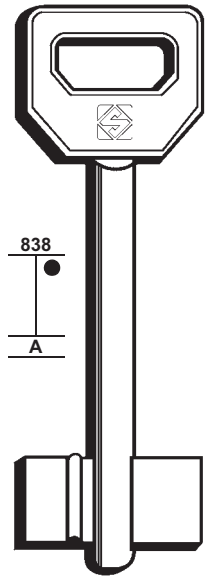

5F113

FOR:
PER:

FIAM

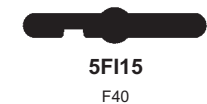
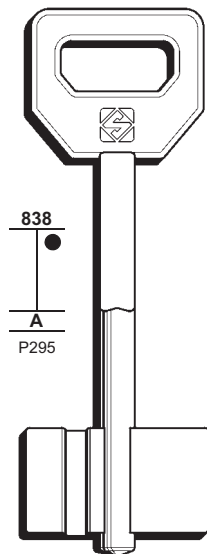

5F115
F40

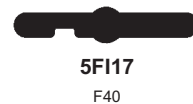
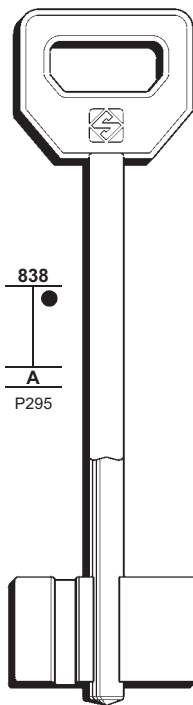

5F117
F40

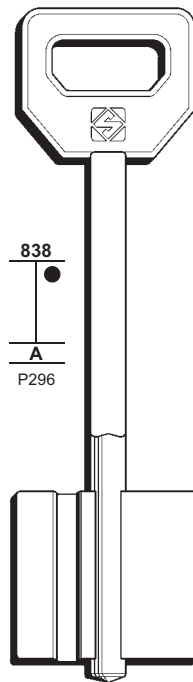

5F119
F39

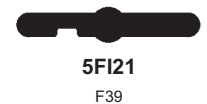
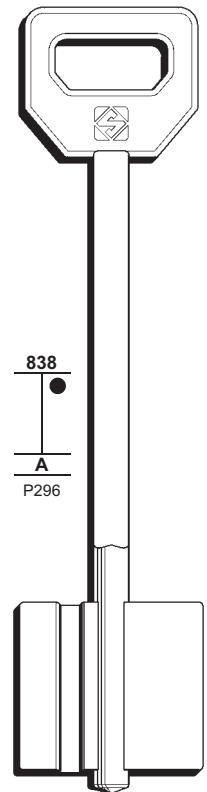

5F121
F39

FOR:
PER:

FIAM



Blue head
Testa blu

P428

A
P429

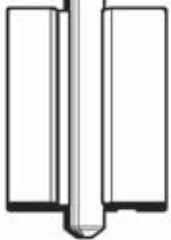

5FI23P

FIAMCA



332

A

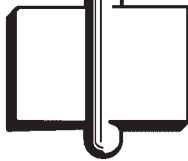

5FC1

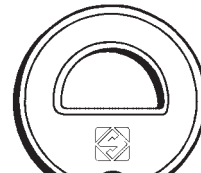

758

A

mm 73,5

ø 5,8

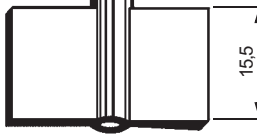

5FC4

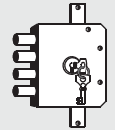
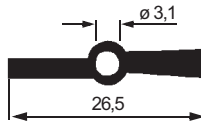

31

FOR/PER

FIAM (I)
+ IDM (34)

FIAMCA (I)

FICHET (F)

FOR:
PER:

FICHET

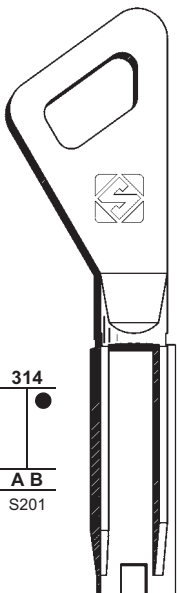

314

A B
S201



FT500

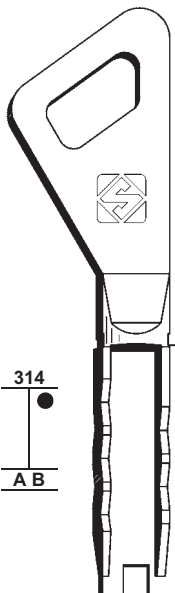

314

A B



FT500C

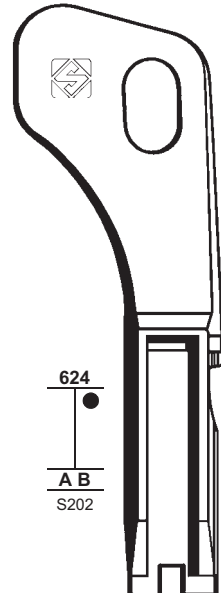

624

A B
S202



FT510

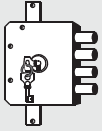

32

FOR/PER
FICHET (F)
FUMEO (I)
PARMA
+ (66-69)

FOR:
PER:

FICHET

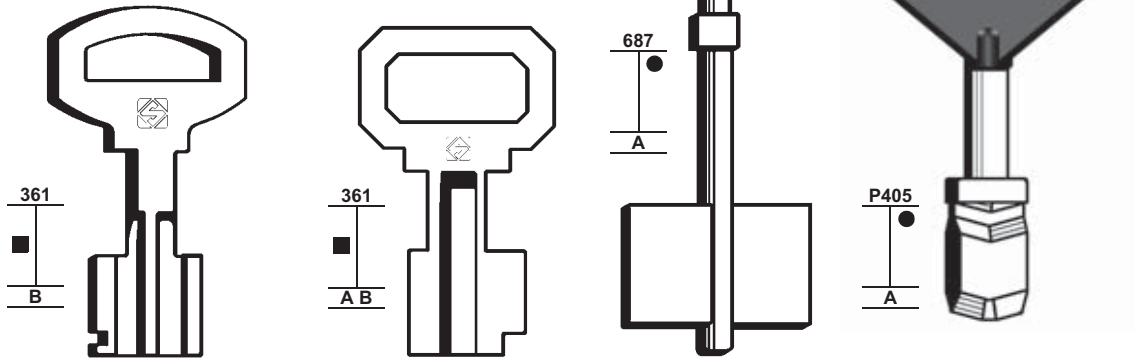

FT7

FT8



FT11

FT12



5FT2



FT525P



FT9



FT14



5FT1



FOR:
PER:

FUMEO

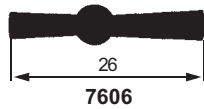
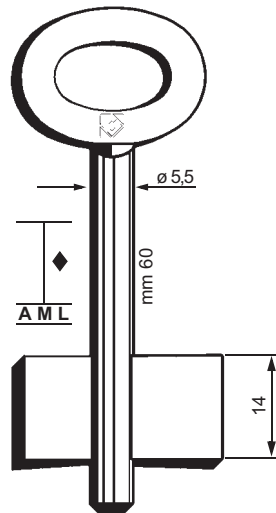

7606

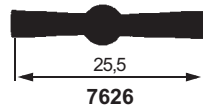
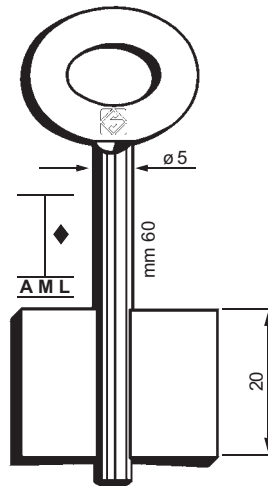

7626

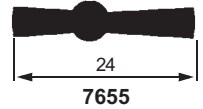
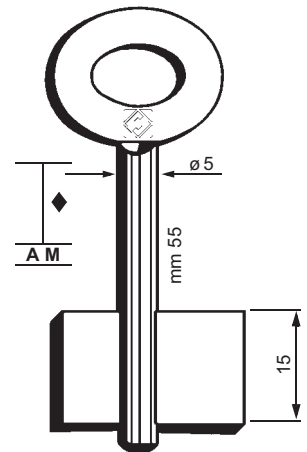

7655

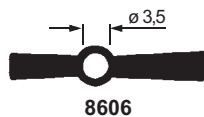

8606

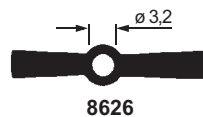

8626

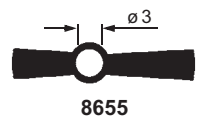

8655

PARMA

PARMA

FOR:
PER:

GB2

GERION

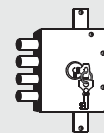

33

FOR/PER

GB2 (I)
GBZ

GBZ (I)
👁️ GB2 (33)

GERION (RUS)
+ 👁️ KERBEROS (39)

GIMAST (I)

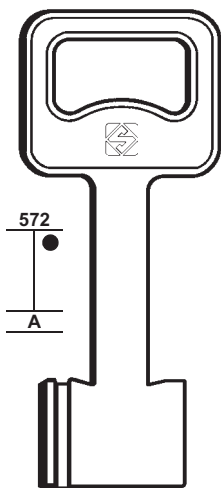

GBZ1

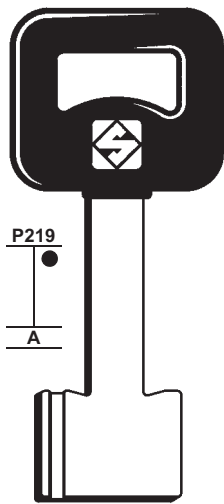

GBZ1P

GBZ

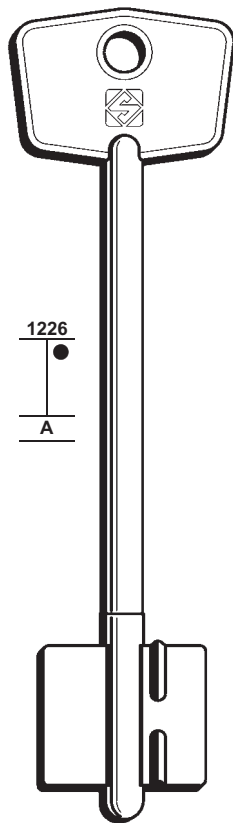

5CER4

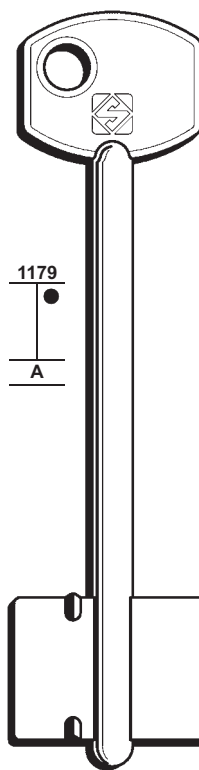

5CER9

FOR:
PER:

GERION

GIMAST

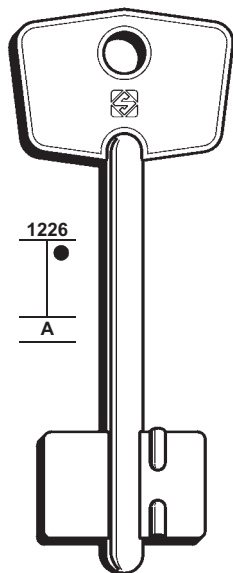

5CER12

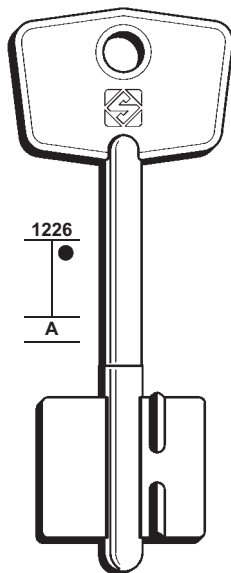

5CER2

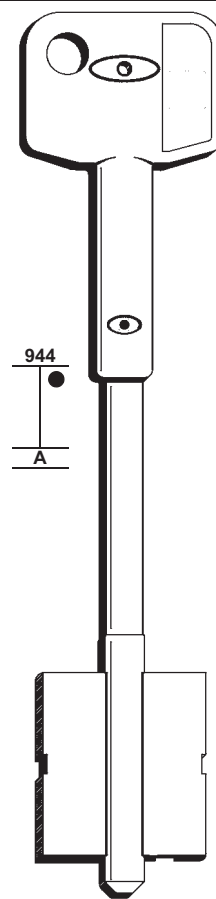

5GMA1T

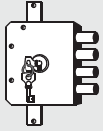

34

FOR/PER

GIPIS (I)
G.P.S.

GLITTENBERG (D)
👁️ (65)

GMG (I)

G.P.S. (I)
👁️ GIPIS (34)

GRODNO (RUS)
👁️ CORNI (16)

GUARDIAN (I)
👁️ FACEF (27)

HAGELIN (S)
👁️ (66)

HEERUM (D)

HK (CZ)

IDM (I)
FASEM
FIAM
VIRO

FOR:
PER:

GIPIS

GMG

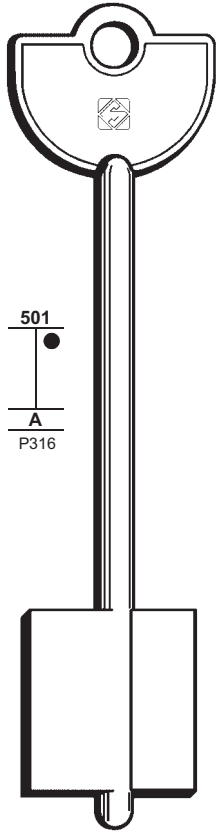

501
A
P316



GIL

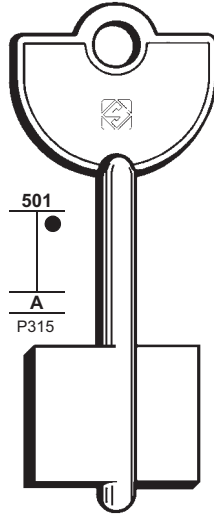

501
A
P315



GIC

G.P.S.

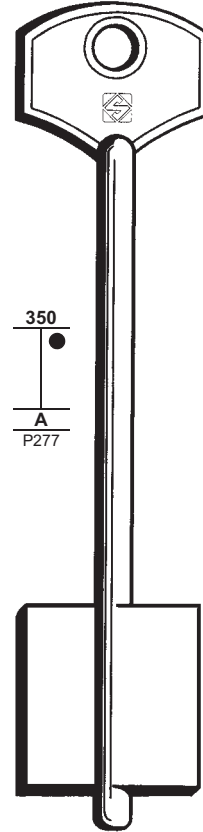

350
A
P277



GL

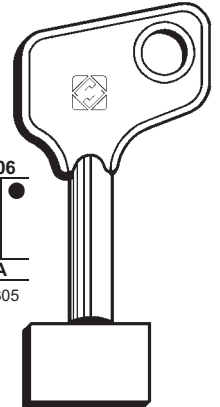

506
A
P305



GP



GPN

FOR:
PER:

HEERUM

HK

IDM

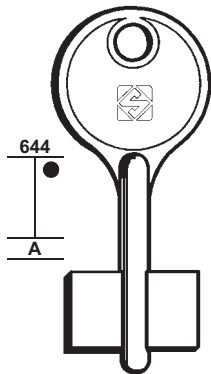

644
A



5HRM1

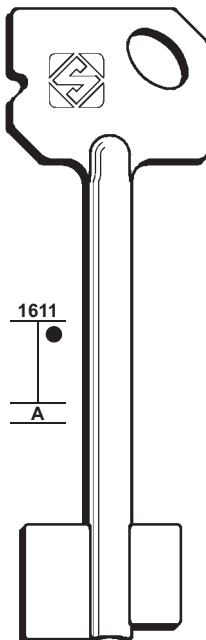

1611
A



5HK1

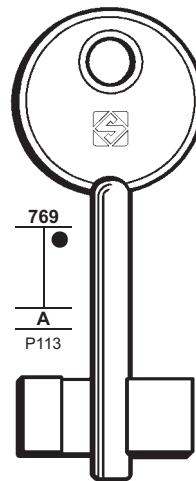

769
A
P113



5ID5

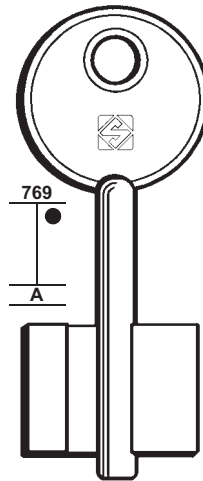

769
A



5ID7

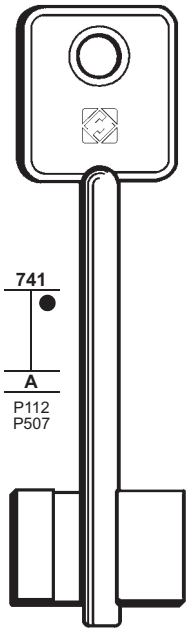

741
A
P112
P507



5ID3

FASEM - FIAM

FASEM

FASEM - FIAM
VIRO

FOR:
PER:

IDM

IMSI

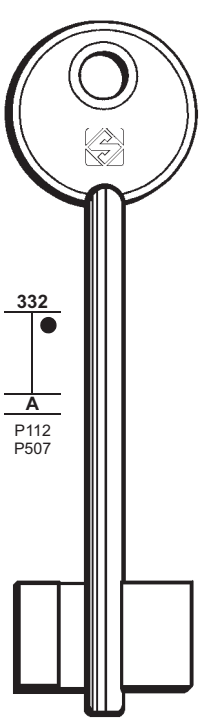

332
A
P112
P507



IDM

FASEM - VIRO

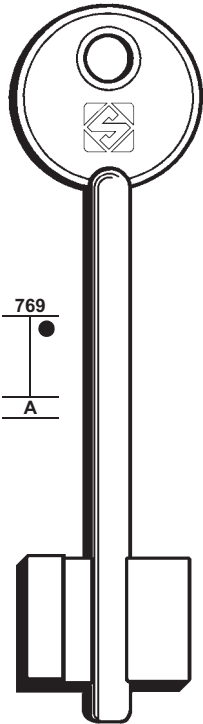

769
A
P226
P507



5ID9

FASEM

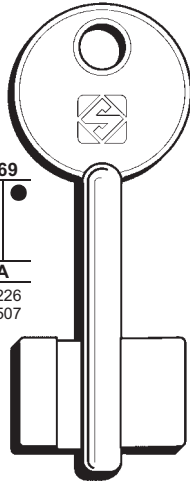

769
A
P226
P507



5ID11

FASEM - VIRO

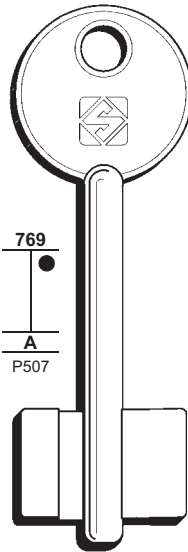

769
A
P226
P507



5ID13

FASEM - VIRO

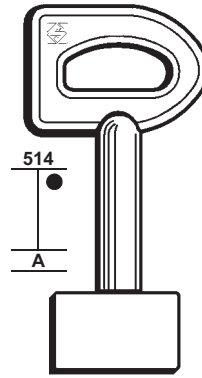

514
A
P120
P190



IPP

PATRONE

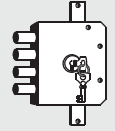

35

FOR/PER

IDM (1)
FASEM
VIRO

IMSI (1)
+ PATRONE

ISEO (1)
AUTORI

FOR:
PER:

ISEO

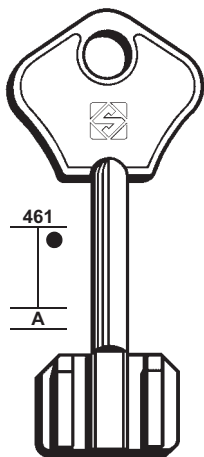

461
A
P116



AUP

AUTORI

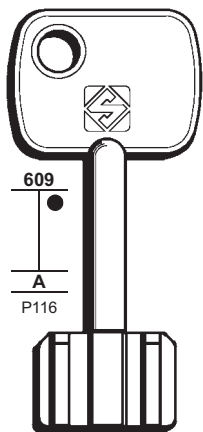

609
A
P116



5IE5

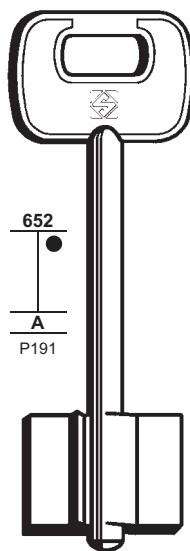

652
A
P191



5IE7

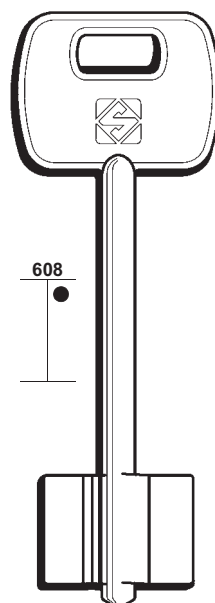

608
A
P120
P190



5IE11

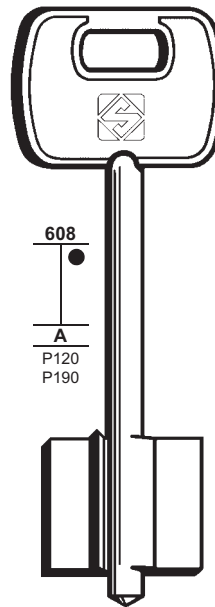

608
A
P120
P190



5IE9

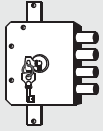

36

FOR/PER

ISEO (I)
AUTORI
MEGABLOCK

ISMET (I)
ESETY (25)

ITAL (I)

FOR:
PER:

ISEO

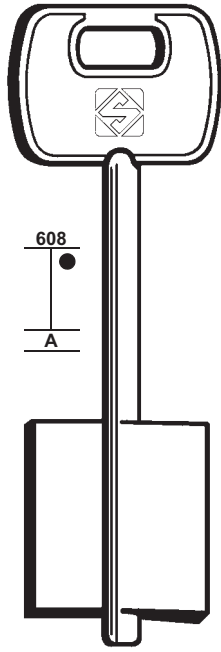

608
A



5IE1

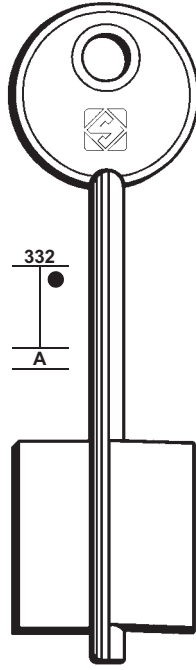

332
A



AUM
AUTORI

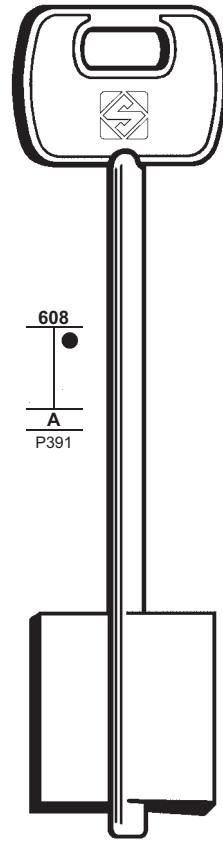

608
A
P391



5IE3
MEGABLOCK

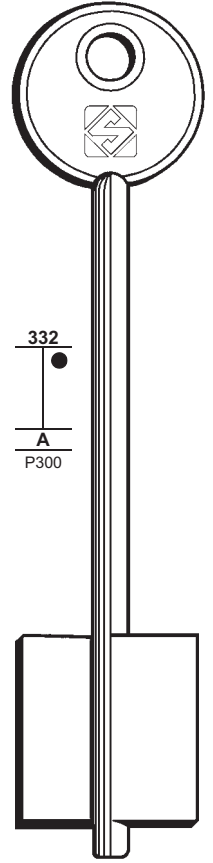

332
A
P300



AUL
AUTORI

FOR:
PER:

ITAL

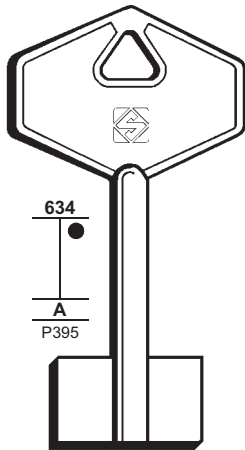

634
A
P395



5IT3

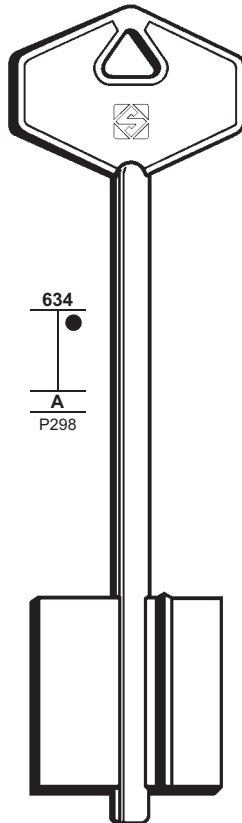

634
A
P298



5IT2

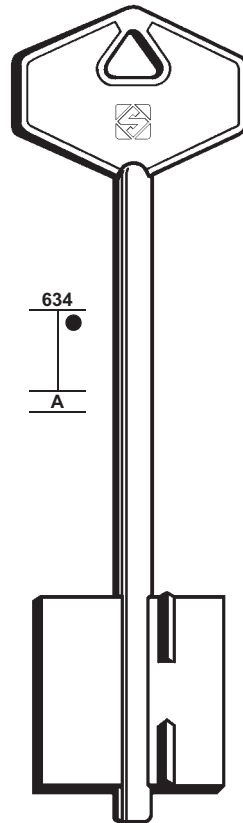

634
A



5IT6

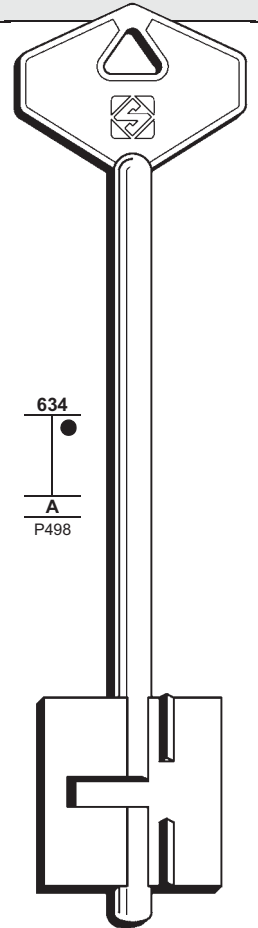

634
A
P498



5IT8

FOR:
PER:

JUWEL

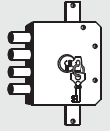

37

FOR/PER

JUWEL (I)
ASIAGHI
BURG-WÄCHTER

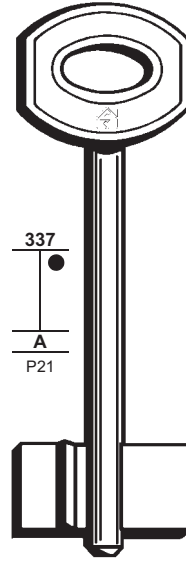
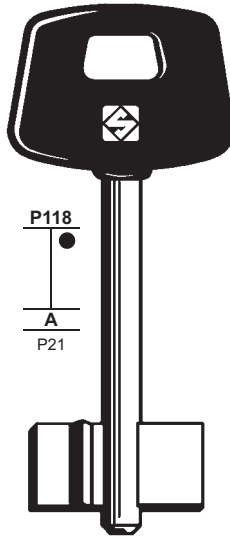
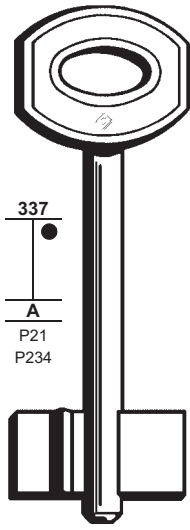
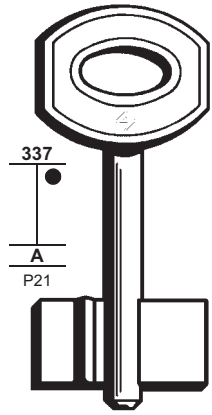

JW20



JW35



JW35P



JW40

BURG-WÄCHTER

BURG-WÄCHTER

FOR:
PER:

JUWEL

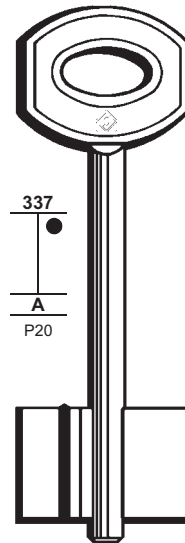
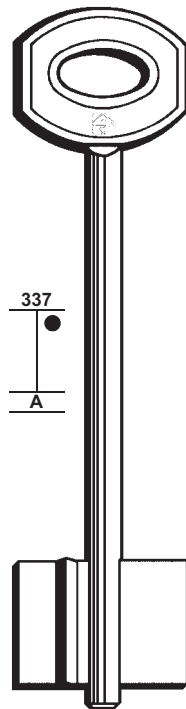
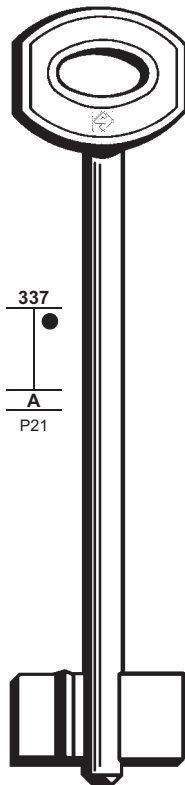
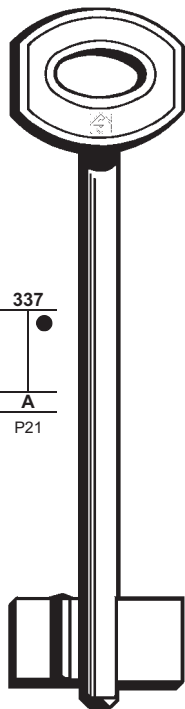
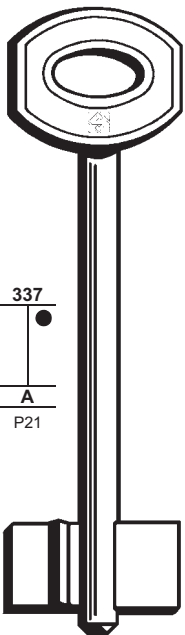

JW50



JW60



JW70



JW90



5JW1

ASIAGHI

BURG-WÄCHTER

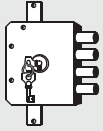

38

FOR/PER

KASSEL (I)
SERMEC
YALE

FOR:
PER:

KASSEL

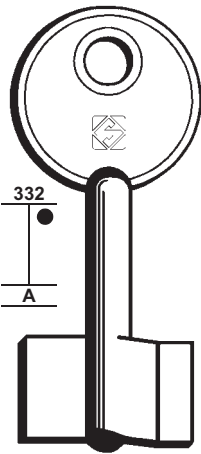

332
A



KYP

YALE

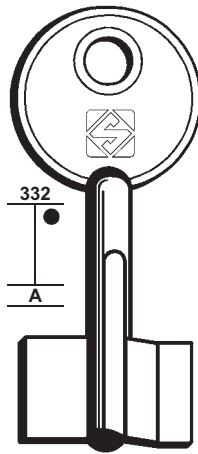

332
A



5KY2

YALE

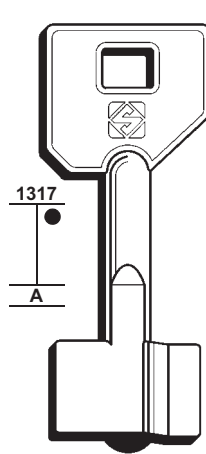

1317
A



5KY6

YALE

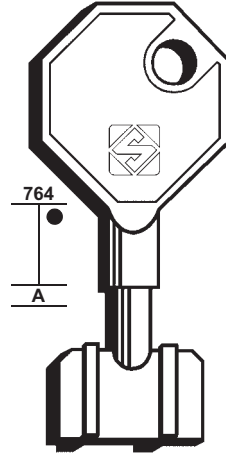

764
A



5K1

YALE

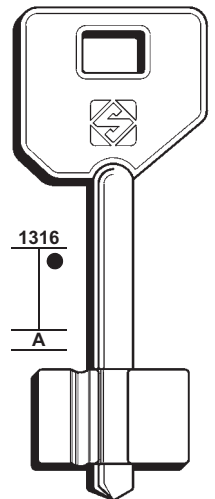

1316
A



5KY7

YALE

FOR:
PER:

KASSEL

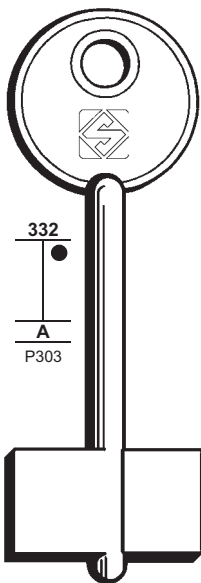

332
A
P303



5KY4
YALE

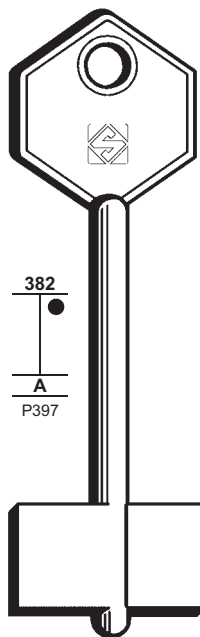

382
A
P397



YC
YALE

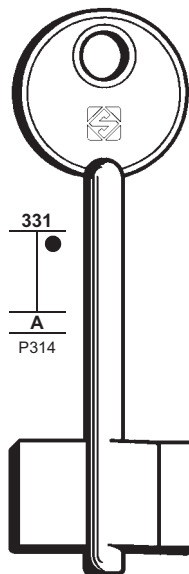

331
A
P314



KC

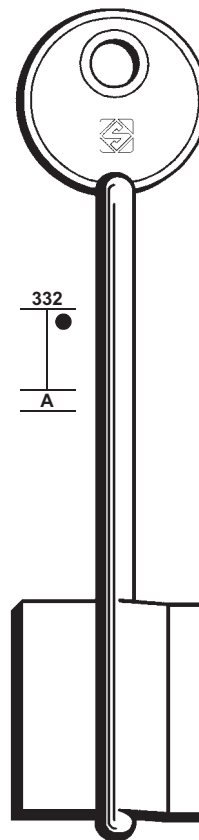

332
A



KYL
YALE

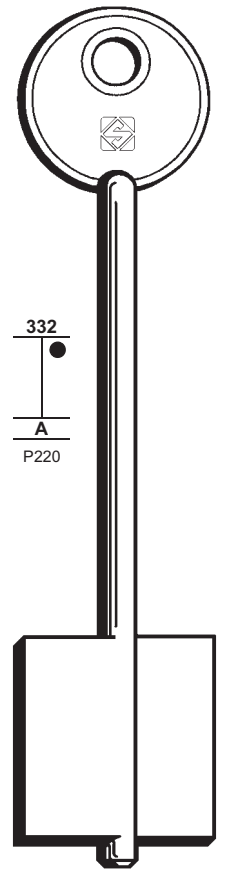

332
A
P220



KL
SERMEC - YALE

FOR:
PER:

KERBEROS

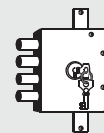

39

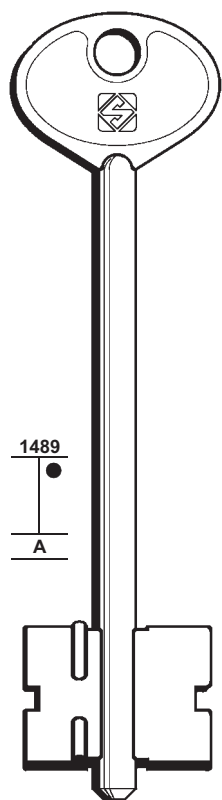

5KRB2

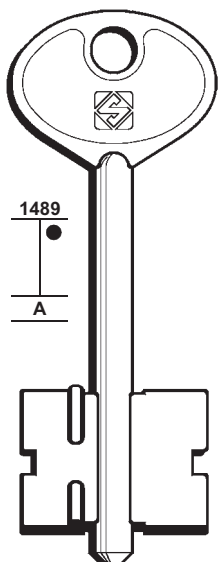

5KRB1

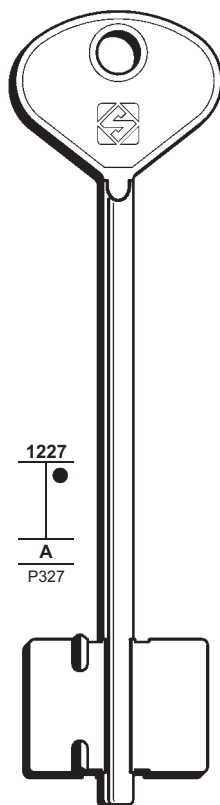

5CER7
GERION

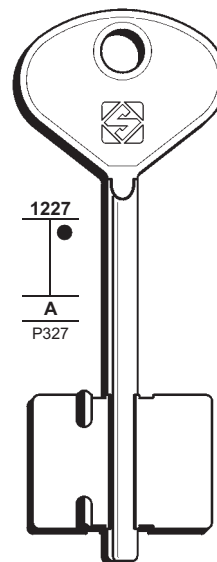

5CER5
GERION

FOR/PER

KERBEROS (RUS)
CERION

KIUSO (I)
EYE POTENT (49)

KREPICH (RUS)

KROMER (D)
EYE (67)

KURZEMES (RUS)

LINCE (E)
EYE CORNI (16)

LIPS-VAGO (I)
+ EYE (71)

FOR:
PER:

KREPICH

KURZEMES

LIPS-VAGO

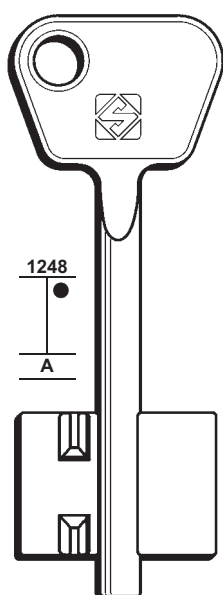

5KRC1

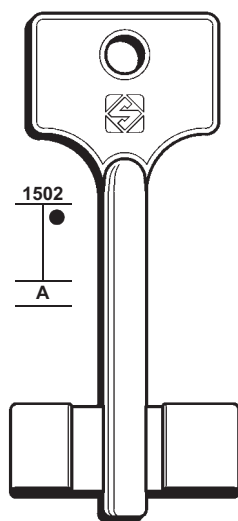

5KU1

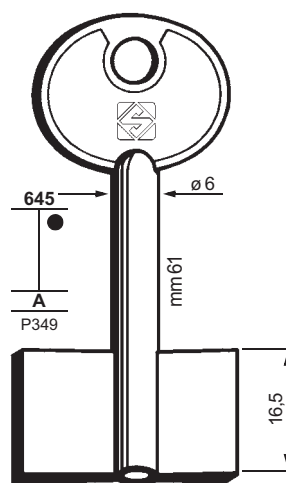

5LV1

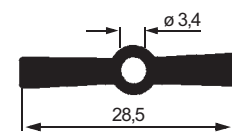

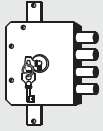

40

FOR/PER

LOWE & FLETCHER
(GB)

MAUER (D)
DEKABA (19)

MAXIM (RUS)

MCM (E)
CISA (14)

MEGABLOCK (I)
ISEO (36)

MELSMETALL (D)
+ (66-73)

METTEM (RUS)

MERONI (I)
SECUREMME (53)

MIA (I)
SAFE (52)

FOR:
PER:

LOWE & FLETCHER

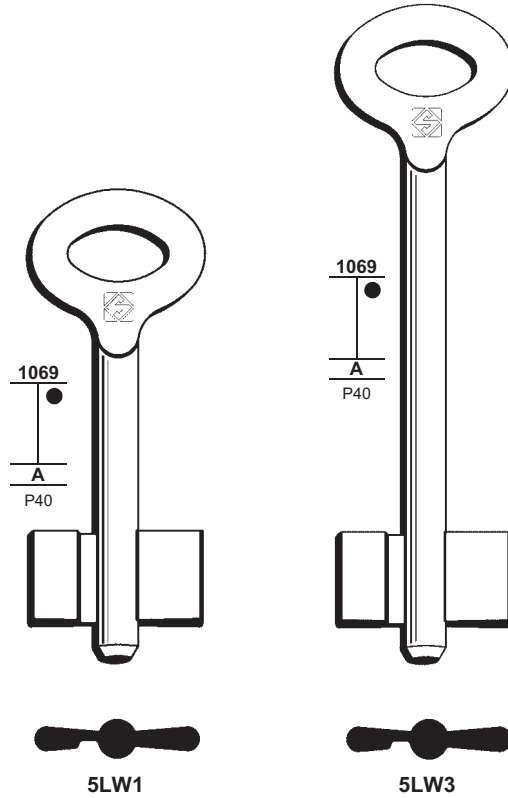

MAXIM

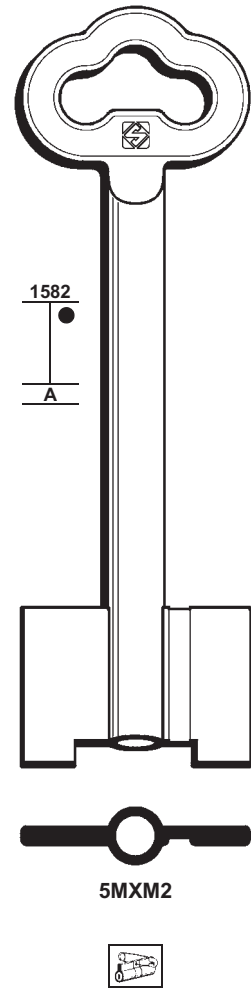

FOR:
PER:

MELSMETALL

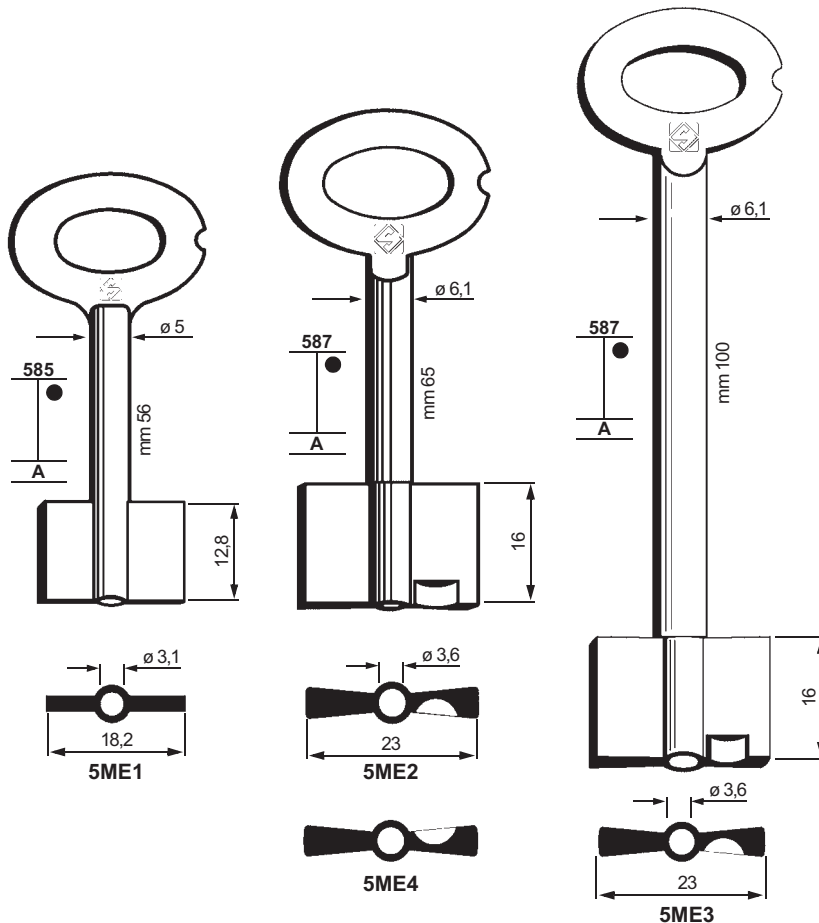

METTEM

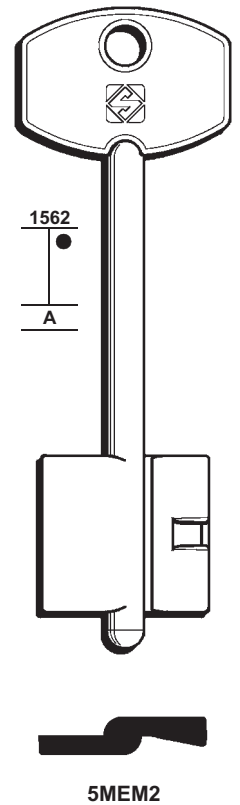

FOR: **MOBELLA**
PER:

MOIA

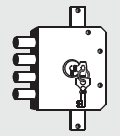

41

FOR/PER

MOBELLA (S)

MOIA (I)
OMR

MOTTURA (I)

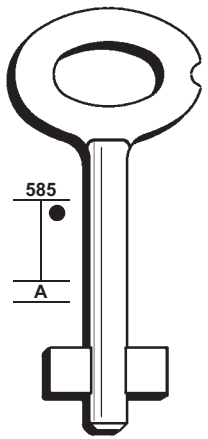

3FMB01

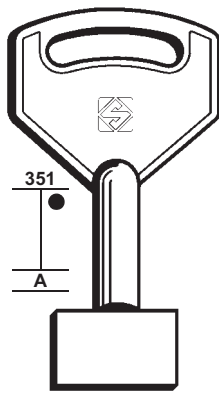

PP

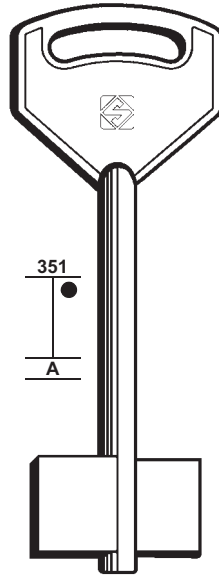

MC

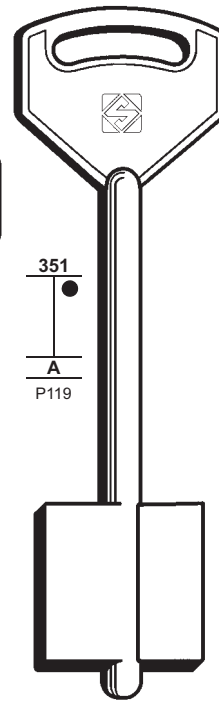

5MO2
OMR

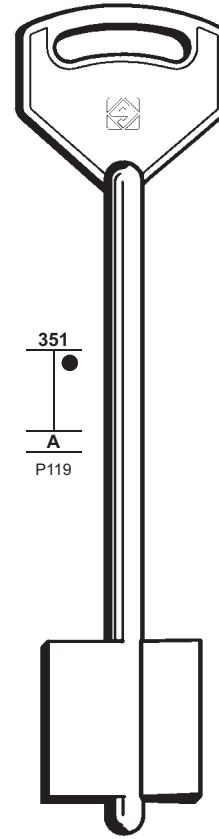

ML
OMR

FOR:
PER:

MOTTURA

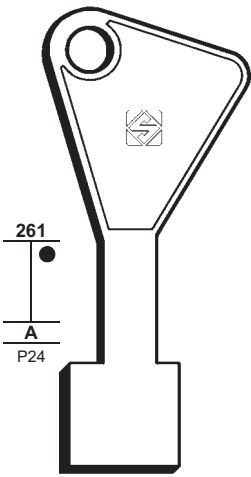

MT2
E

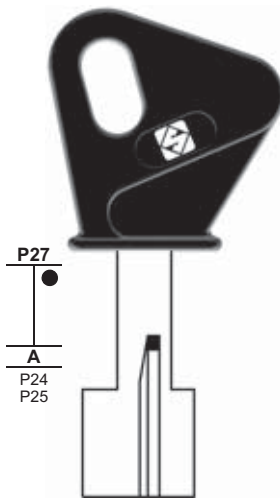

MT2P
E

MT2RP
H

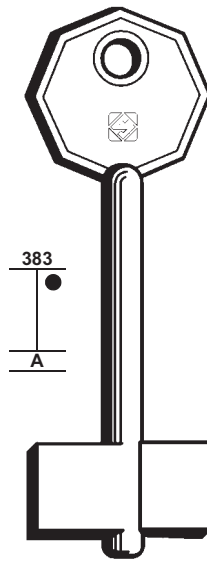

MT

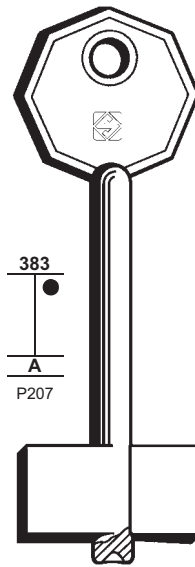

MTF



MT3
C



MT3P
C



MT3RP
F

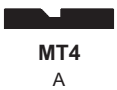

MT4
A



MT4P
A



MT4RP
G

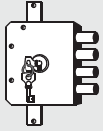

42

FOR/PER

MOTTURA (I)
FEDELI

FOR:
PER:

MOTTURA

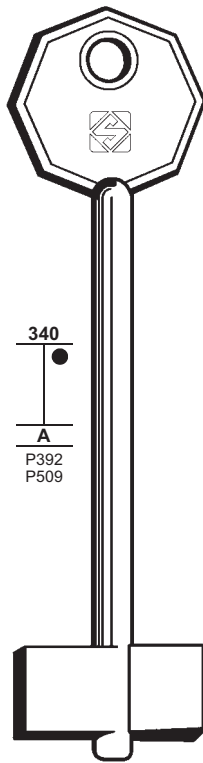

340
A
P392
P509



5MT12

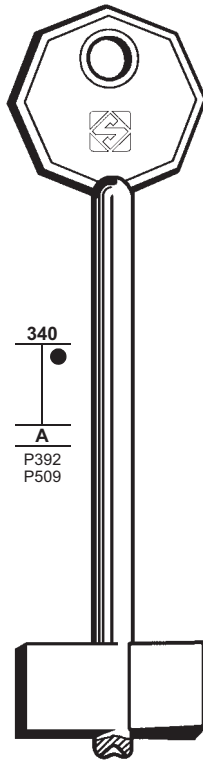

340
A
P392
P509



5MT12F

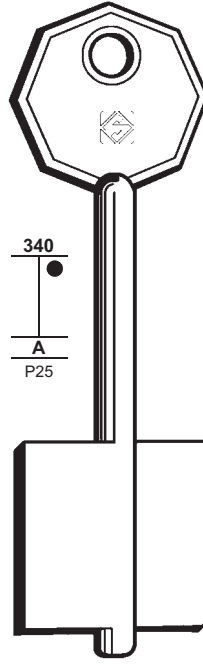

340
A
P25



MTM

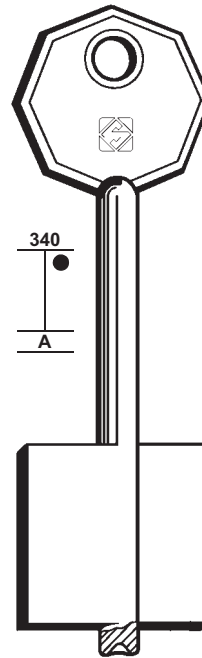

340
A



MTMF

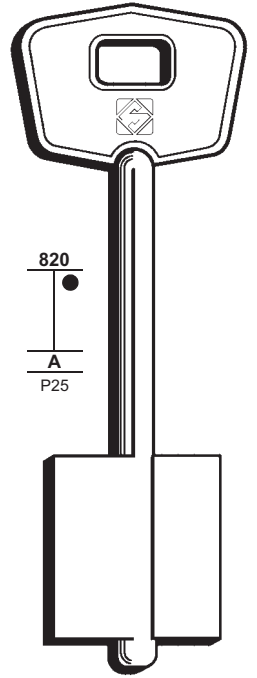

820
A
P25



5MT14

FOR:
PER:

MOTTURA

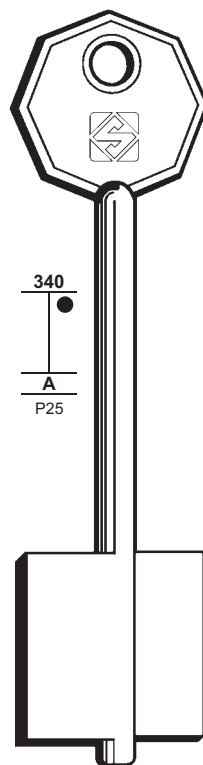

340
A
P25



5MT2

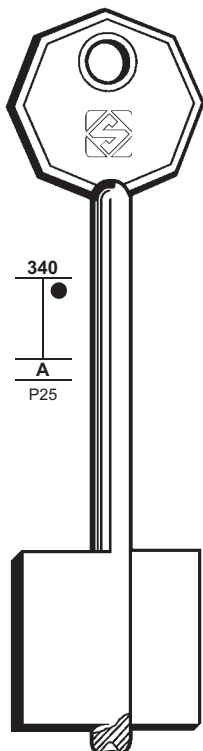

340
A
P25



5MT2F

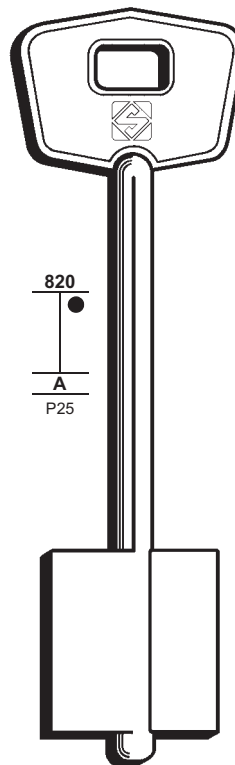

820
A
P25



5MT16

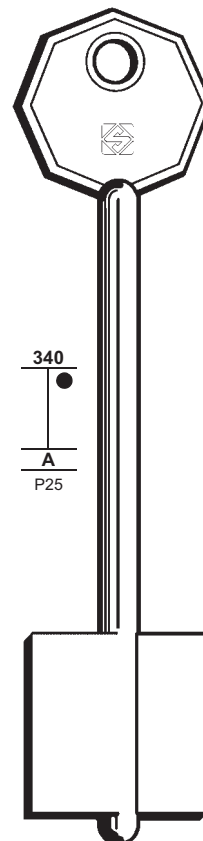

340
A
P25



MTL

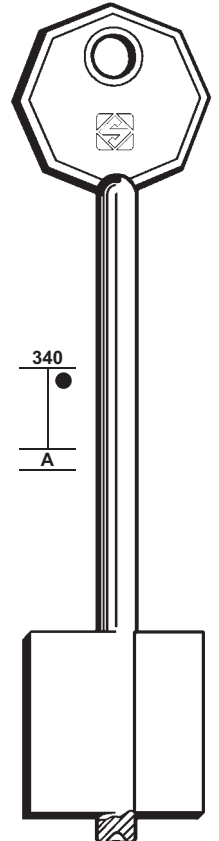

340
A



MTLF

FEDELI

FOR:
PER:

MOTTURA

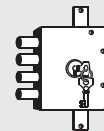

43

FOR/PER

MOTTURA (I)

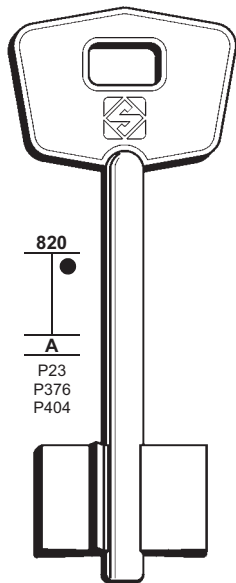

820

A

P23
P376
P404



5MT3

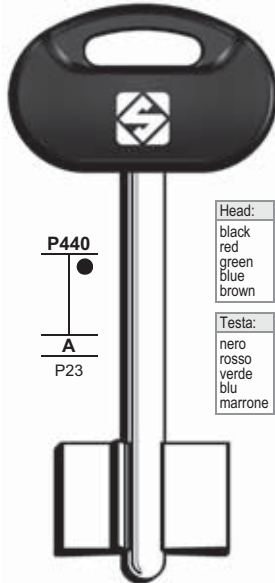

P440

A

P23

Head:
black
red
green
blue
brown

Testa:
nero
rosso
verde
blu
marrone



5MT3BP

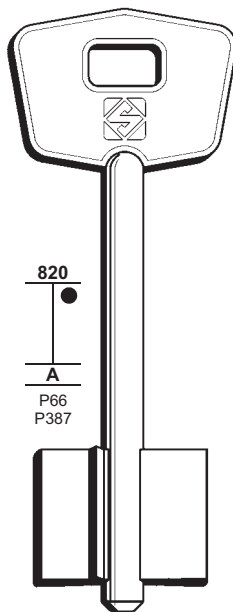

820

A

P66
P387



5MT7

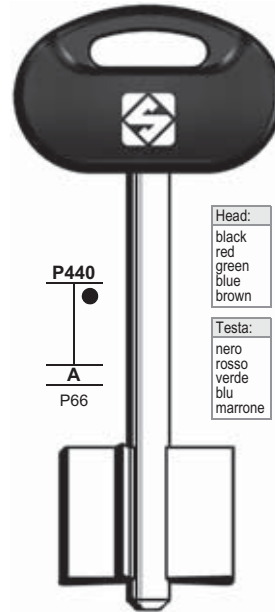

P440

A

P66

Head:
black
red
green
blue
brown

Testa:
nero
rosso
verde
blu
marrone



5MT7BP

FOR:
PER:

MOTTURA

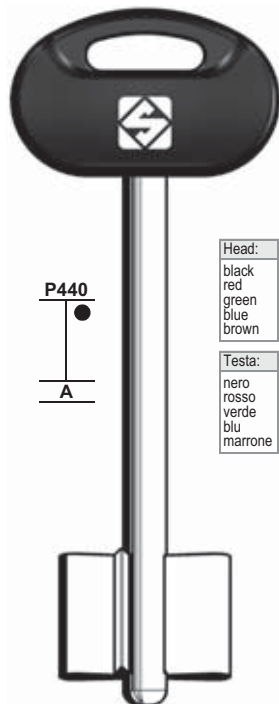

P440

A

Head:
black
red
green
blue
brown

Testa:
nero
rosso
verde
blu
marrone



5MT21BP

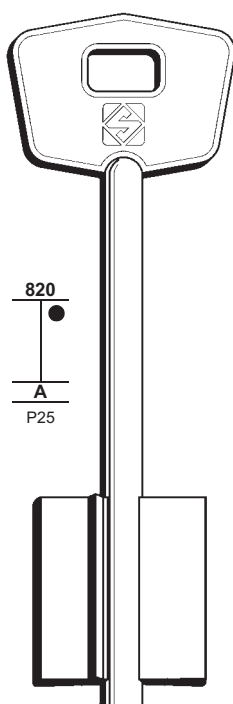

820

A

P25



5MT5

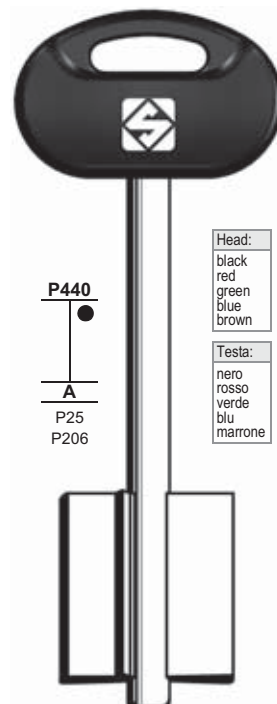

P440

A

P25
P206

Head:
black
red
green
blue
brown

Testa:
nero
rosso
verde
blu
marrone



5MT5BP

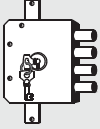

FOR:

PER:

MOTTURA

44

FOR/PER

MOTTURA (I)

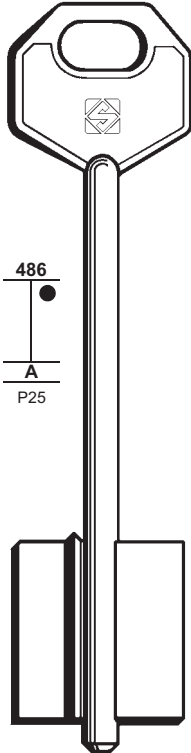

486
A
P25

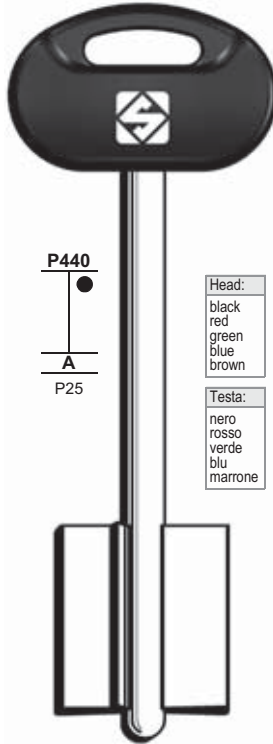

P440
A
P25

Head:
black
red
green
blue
brown

Testa:
nero
rosso
verde
blu
marrone

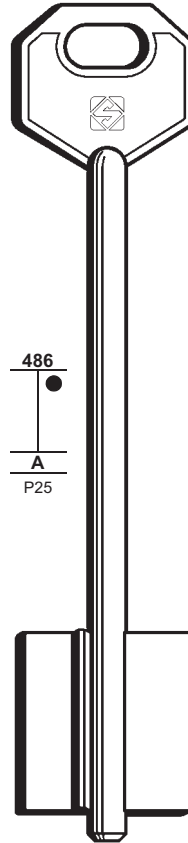

486
A
P25

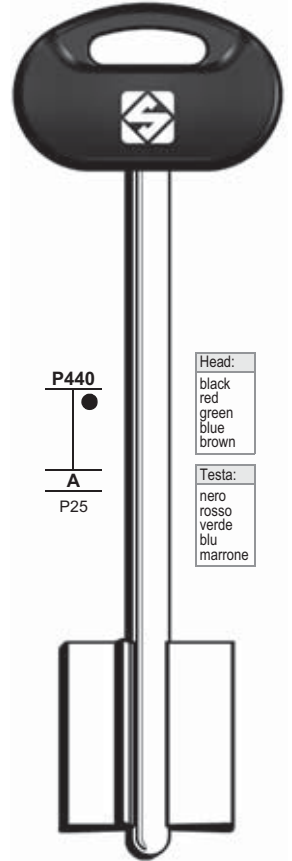

P440
A
P25

Head:
black
red
green
blue
brown

Testa:
nero
rosso
verde
blu
marrone



5MT9



5MT9BP



MTNC



MTNCBP



5MT10



5MT10BP



MTN



MTNBP

FOR:
PER:

MOTTURA

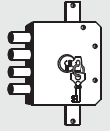

45

FOR/PER

MOTTURA (1)

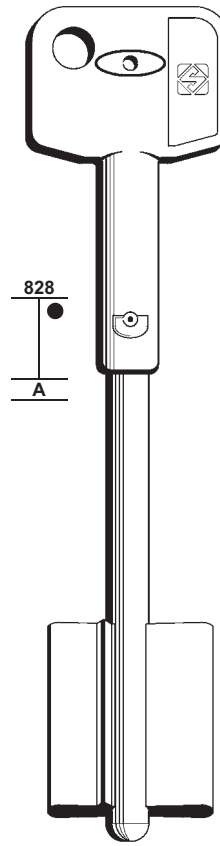
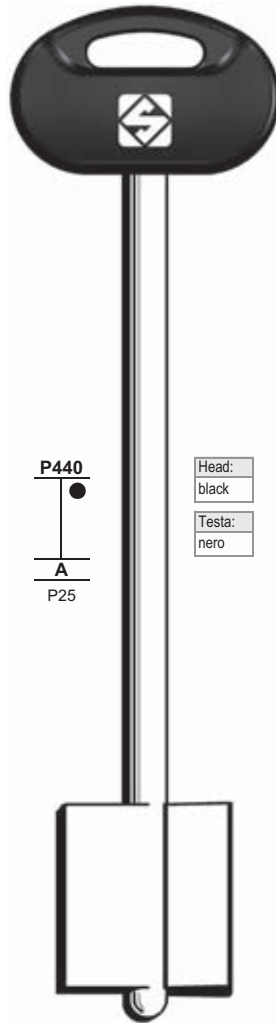
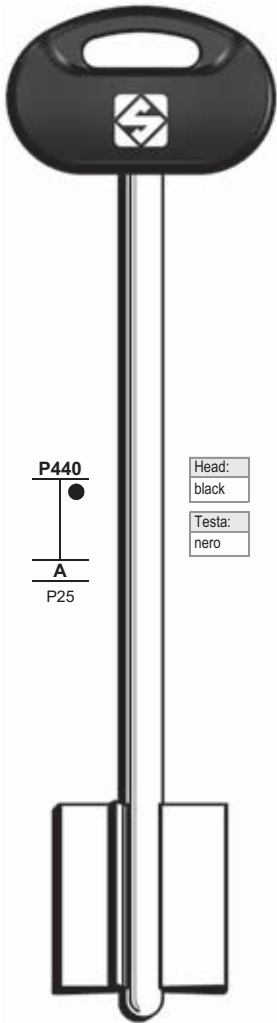

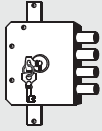

46

FOR/PER

MUEL (F)
VAK

FOR:
PER:

MUEL

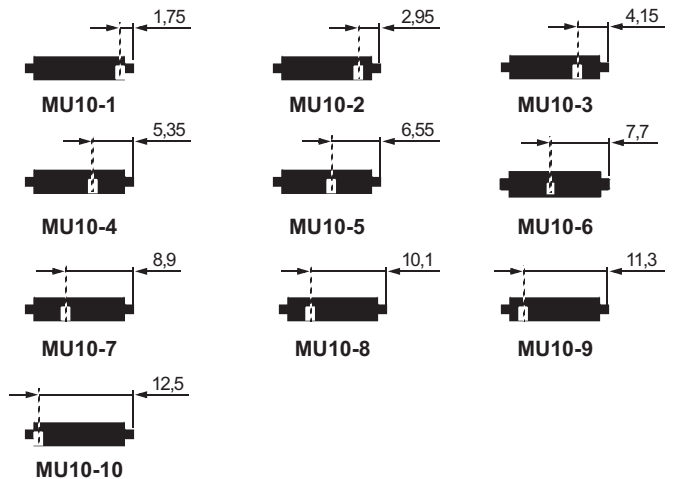
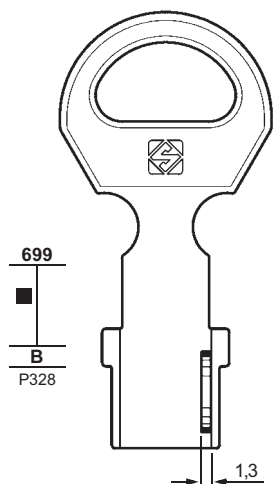
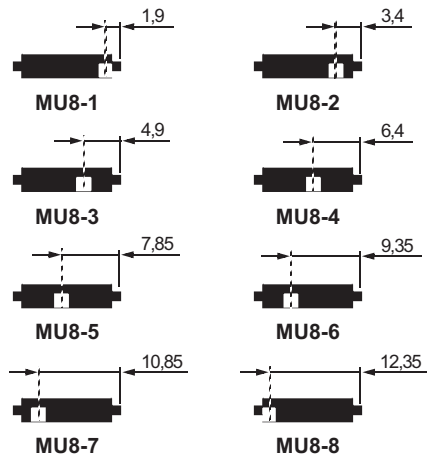
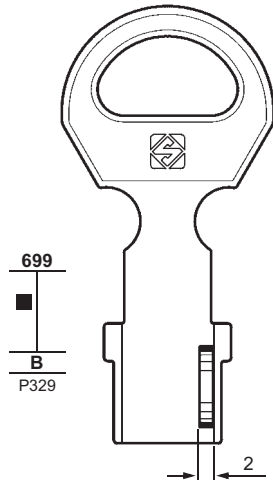
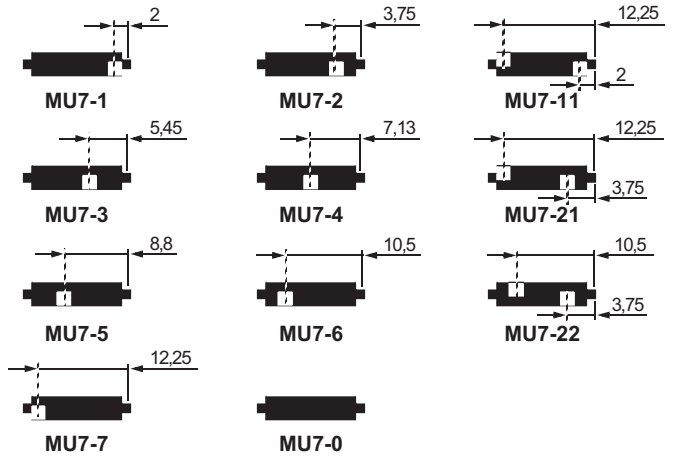
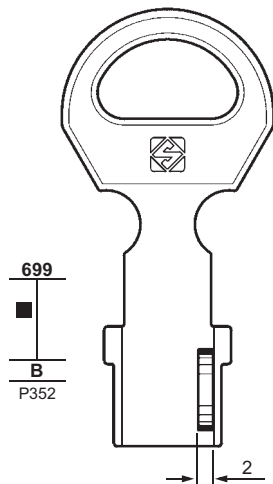
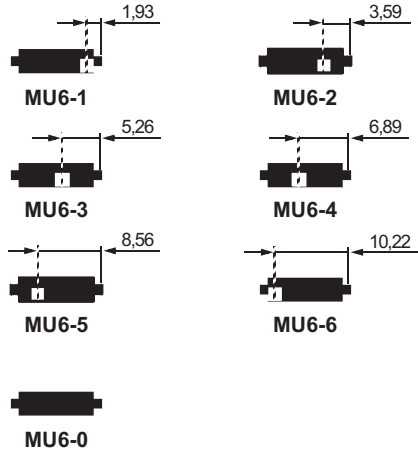
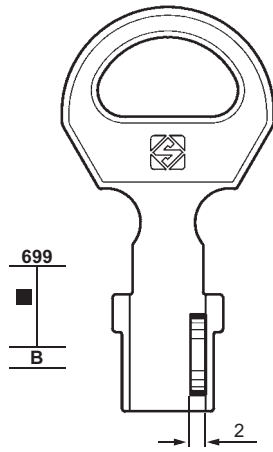

VAK

FOR:
PER:

OMEK

OSLA

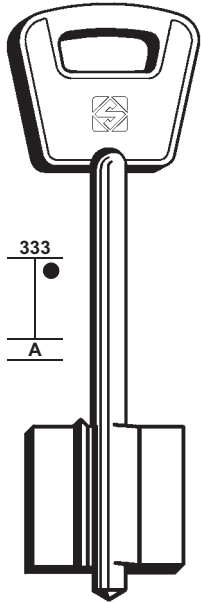

50C1

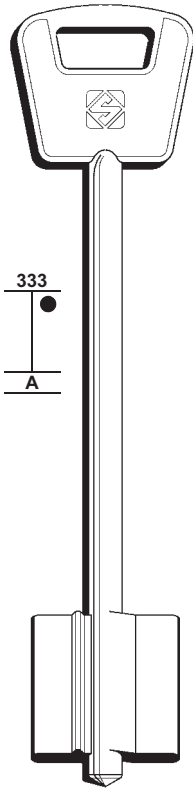

50C3

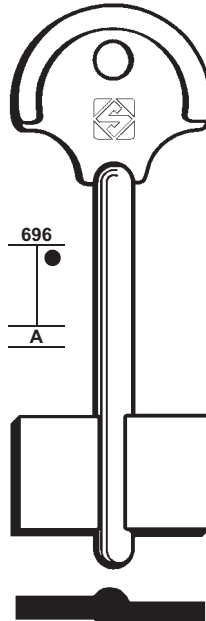

5OSL1

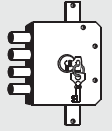

47

FOR/PER

OMEK (I)

OMR (I)
+ MOIA (41)

OSLA (I)
+ CERUTTI (11-12)

PARMA-PAS (I)
+ FUMEO (32)
+ (72-76-78)

FOR:
PER:

PARMA-PAS

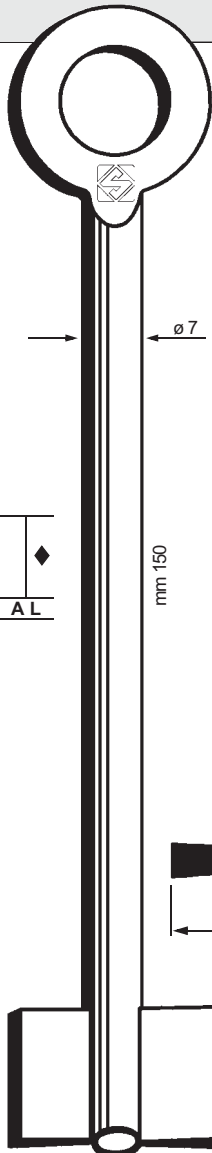

8615

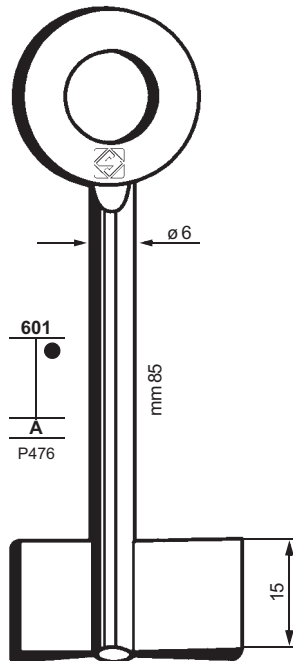

8385PA

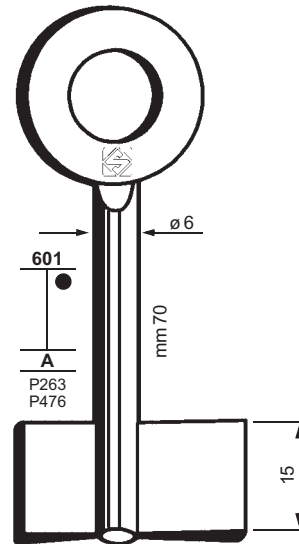

8370PA

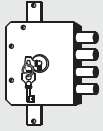

48

FOR/PER

PATRONE (I)
IMSI

PETTITI (I)

PREFER (I)
+ POTENT (48)

FOR:
PER:

PATRONE

PETTITI

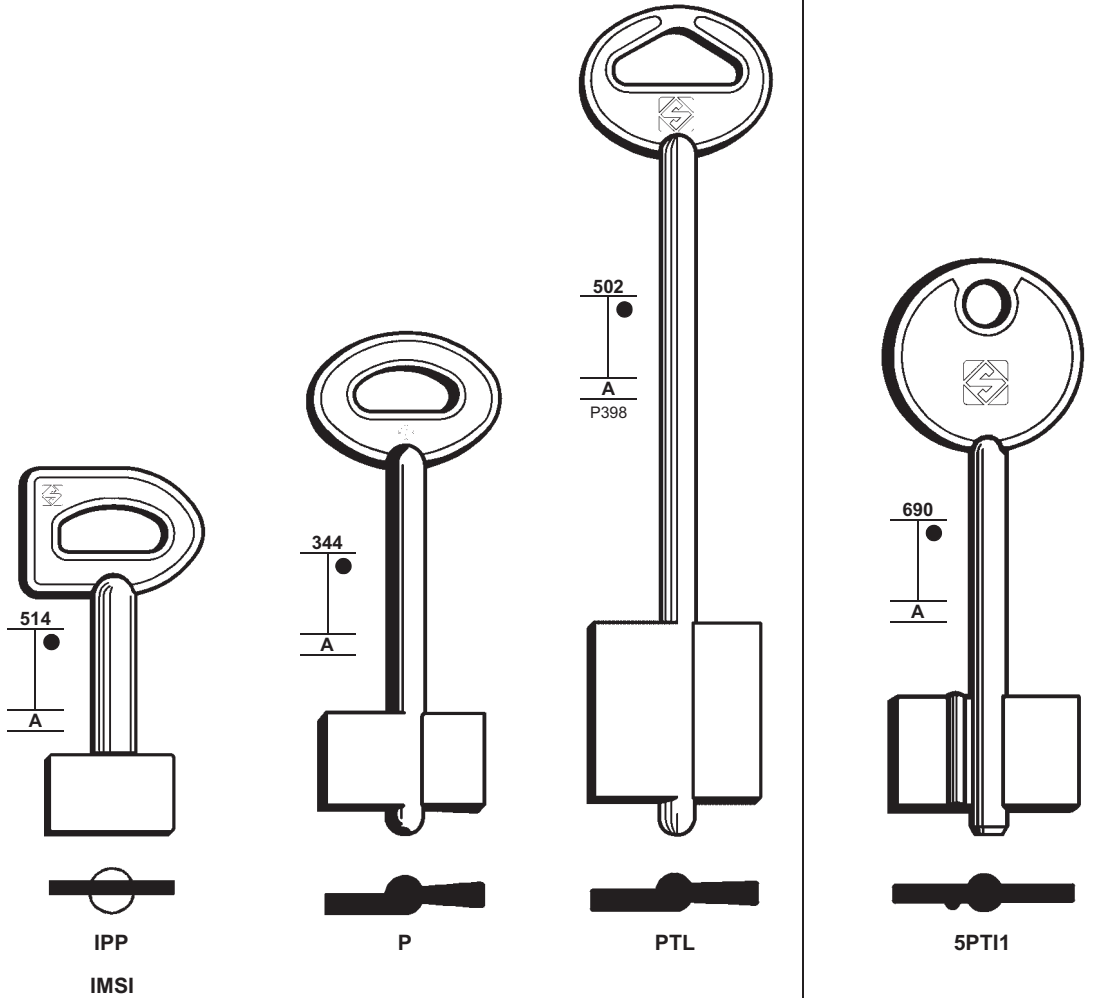

FOR:
PER:

POTENT

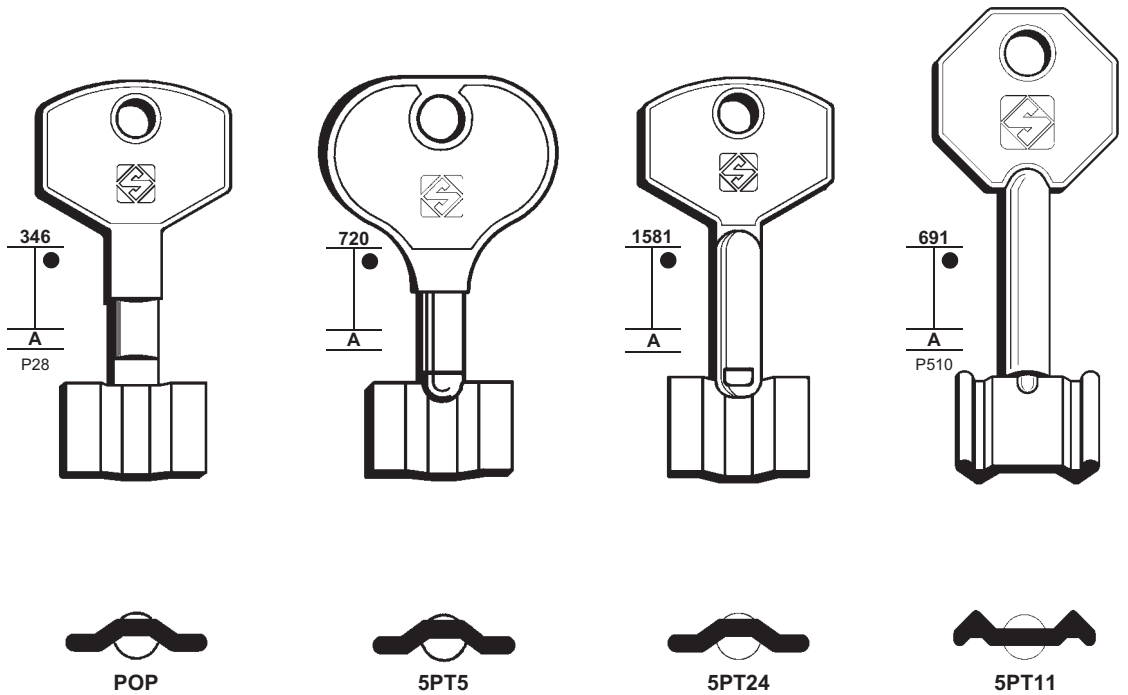

FOR:
PER:

POTENT

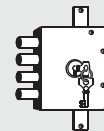

49

FOR/PER

POTENT (I)

ET

PREFER

VIRO

+  BETA (6)

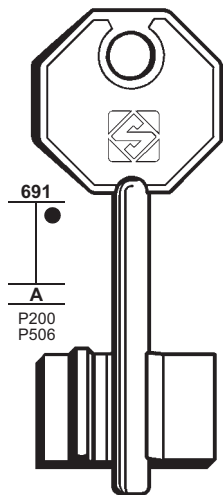

5PT3

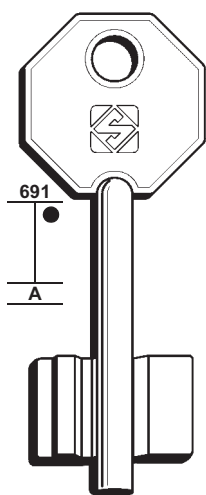

5PT13

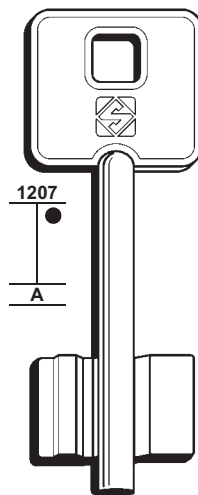

5PT21

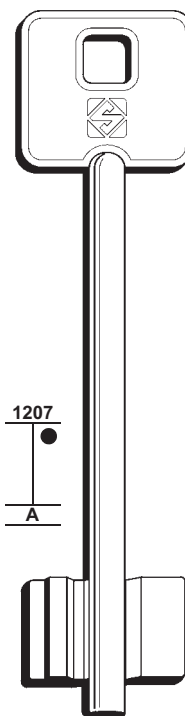

5PT15

ET - PREFER - VIRO

FOR:
PER:

POTENT

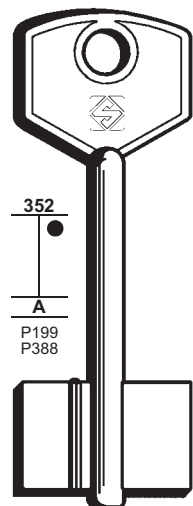

PO

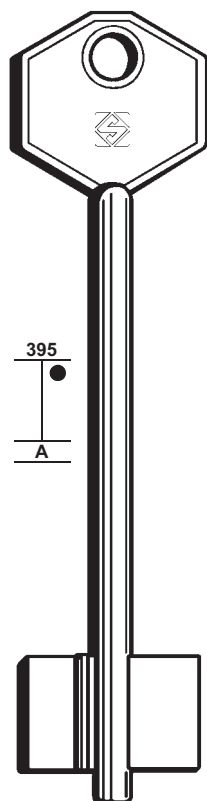

POL

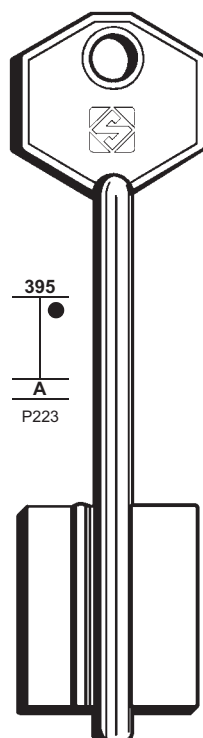

5PT1

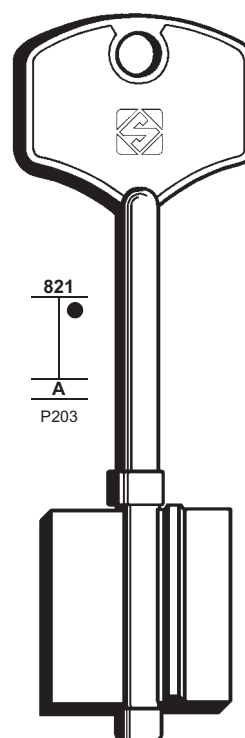

5PT2

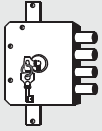

50

FOR/PER

POTENT (I)
KIUSO
VIPER
+ BETA (6)

FOR:
PER:

POTENT

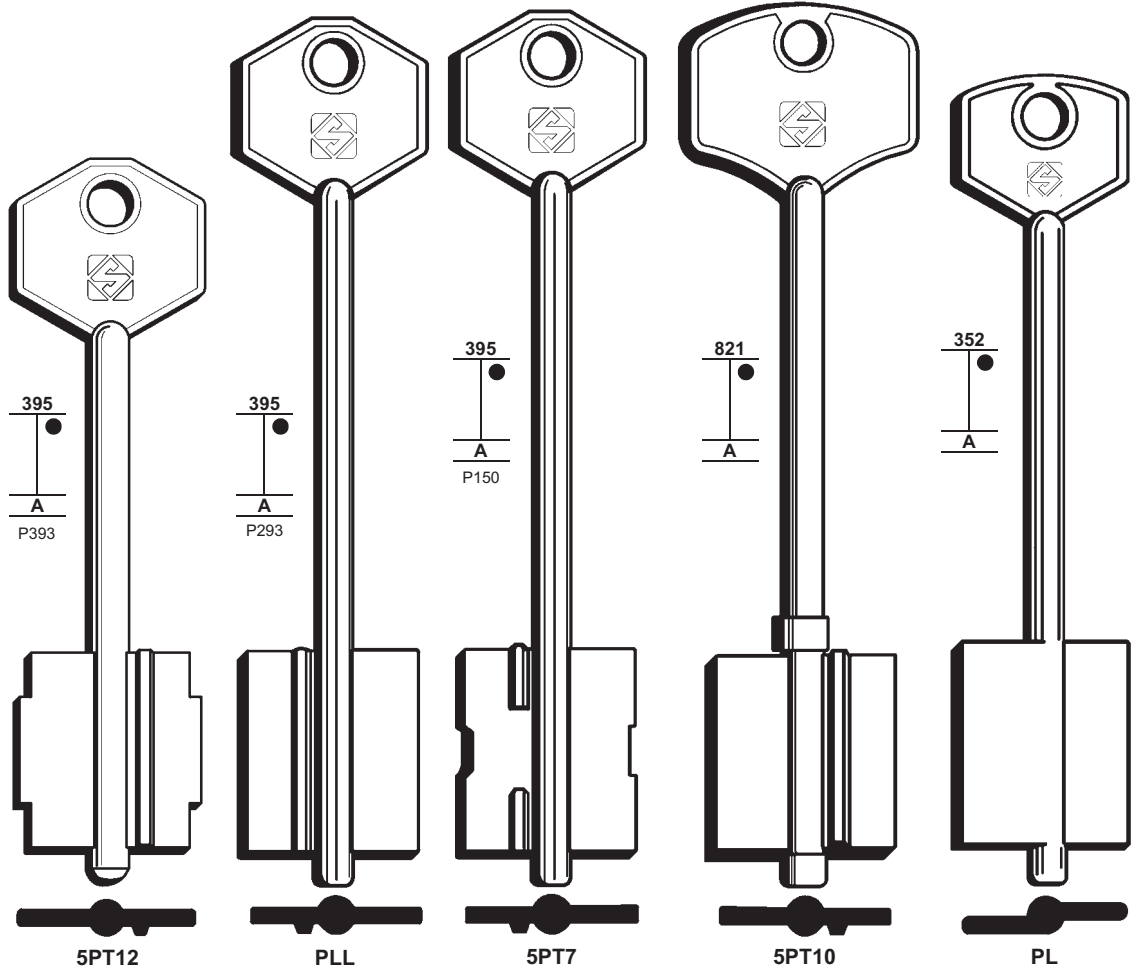

KIUSO - VIPER

FOR:
PER:

POTENT

PREFER

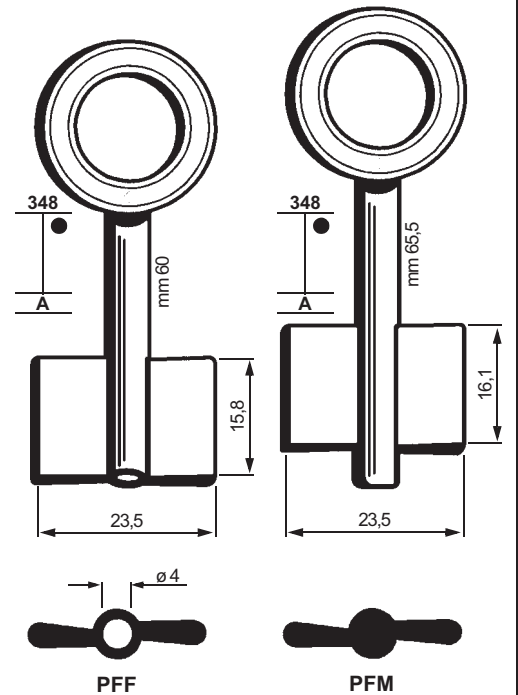
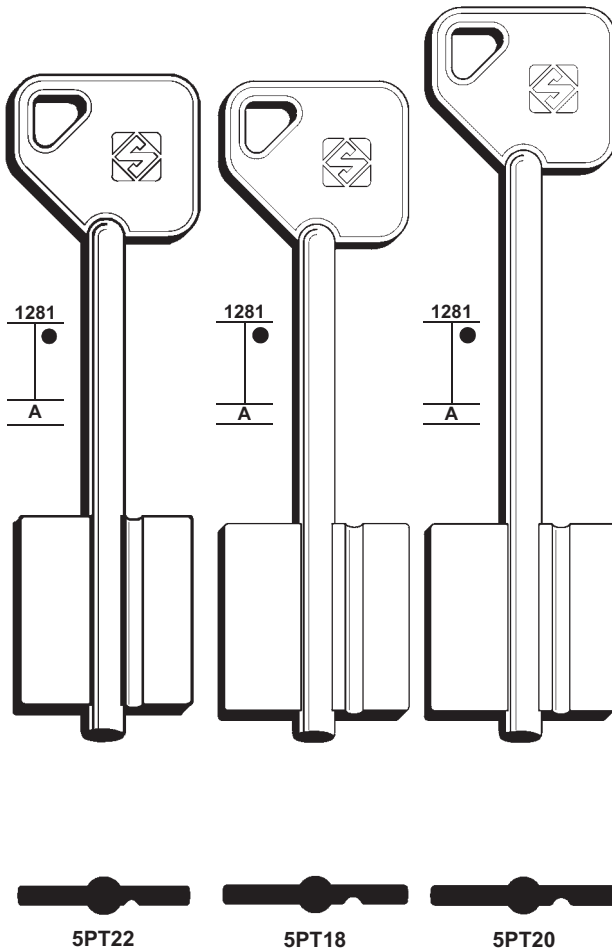

FOR:
PER:

PREFER

R.G.

ROLEX

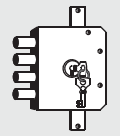

51

FOR/PER

POTENT (I)
+ BETA (6)

4TR (I)
 (59)

R.G. (I)
(RAINONI G.)

ROLEX (GR)
+ (73)

ROSENGREN (S)
+ (71)

RUSSIA (RUS)

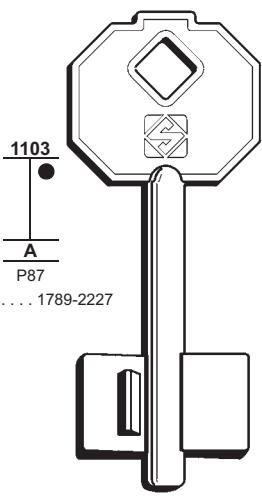

1103
A
P87
... 1789-2227



5PF1

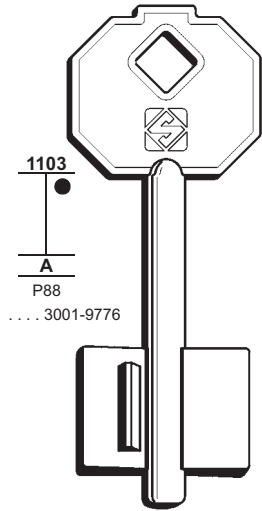

1103
A
P88
... 3001-9776



5PF3

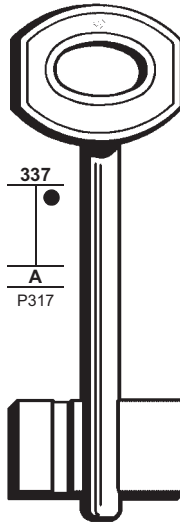

337
A
P317



RGC

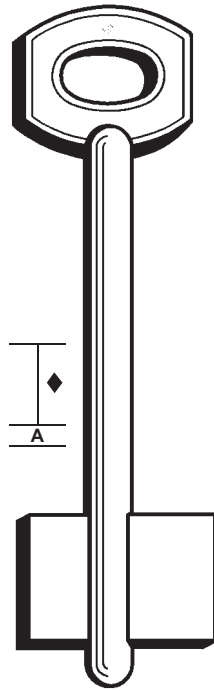

A



8384R

FOR:
PER:

ROSENGREN

RUSSIA

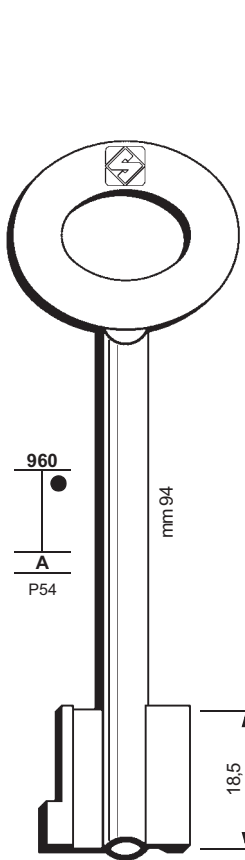

960
A
P54

18,5

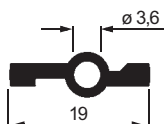

5RSG2

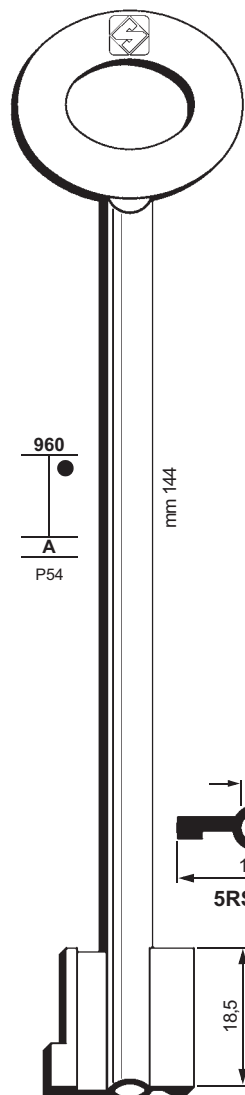

960
A
P54

mm 144

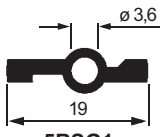

5RSG1

18,5

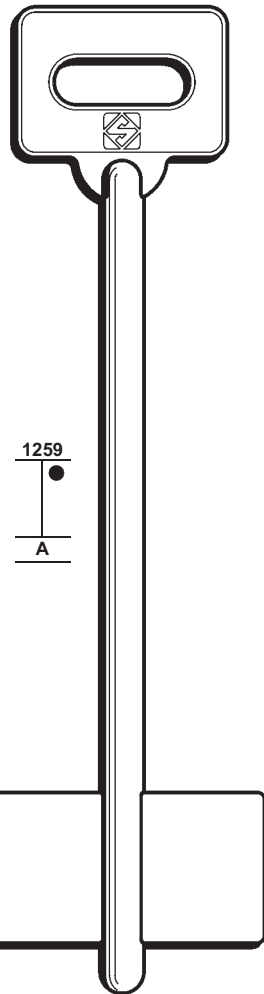

1259
A



5RUS1

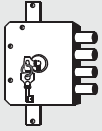

52

FOR/PER

SAB (I)
+ SECUREMME (53)

SAFE (I)
MIA
SETEC

SEA (I)

SECURCASA (I)
 (72)

SECURITAS (I)
 (65)

FOR:
PER:

SAB

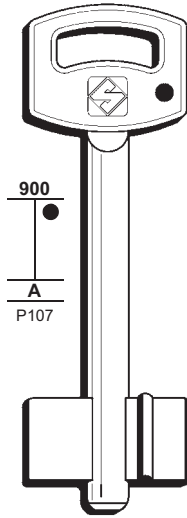

5SAB2

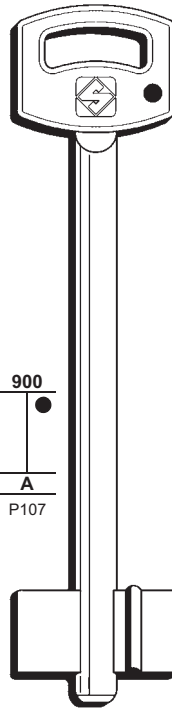

5SAB4

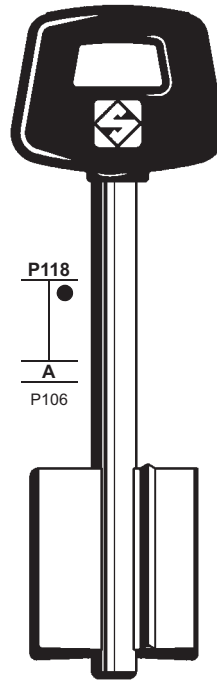

5SAB6P

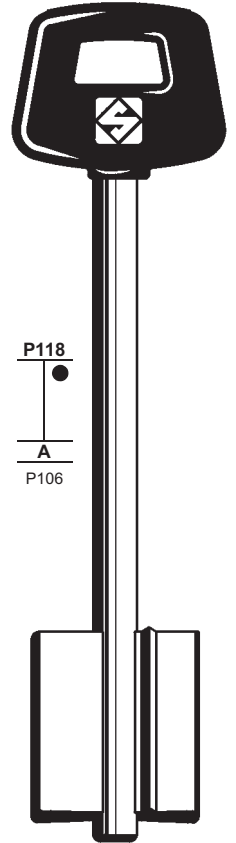

5SAB8P



FOR:
PER:

SAFE

SEA

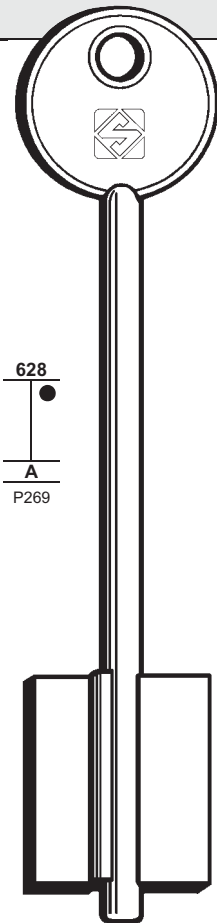

5MS1

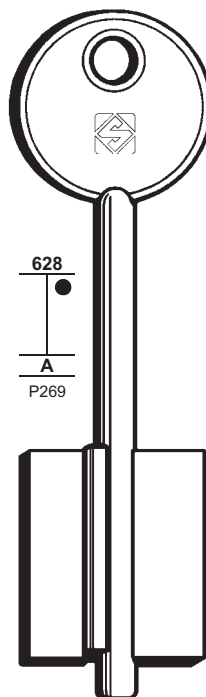

5MS3

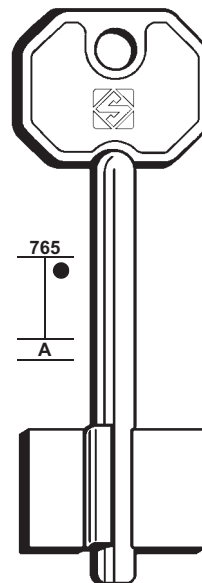

5MS5

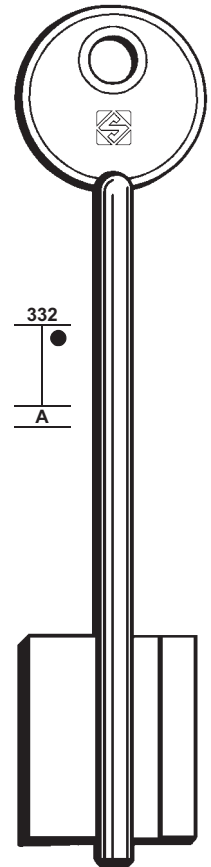

SE



MIA - SETEC

FOR:
PER:

SECUREMME

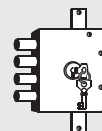

53

FOR/PER

SECUREMME (I)

CORNI
EMME
MERONI
SAB
SIBI
TO
TROLESE

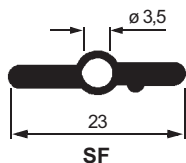
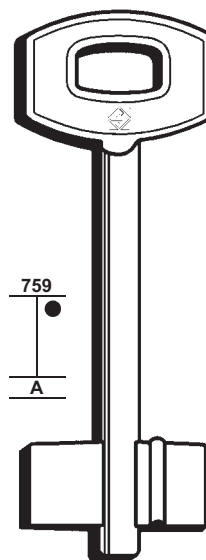
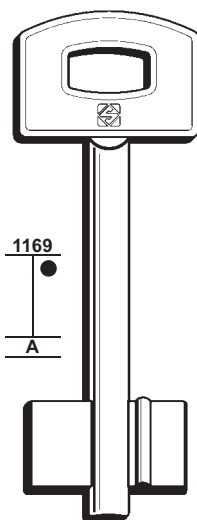
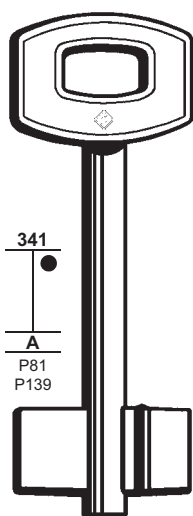
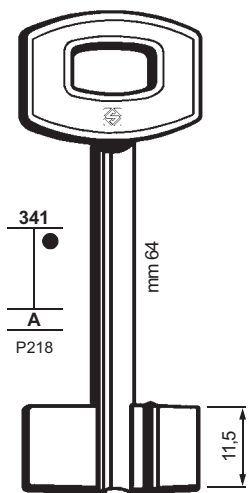

CORNI - EMME - MERONI - SAB - SIBI - TO - TROLESE

FOR:
PER:

SECUREMME

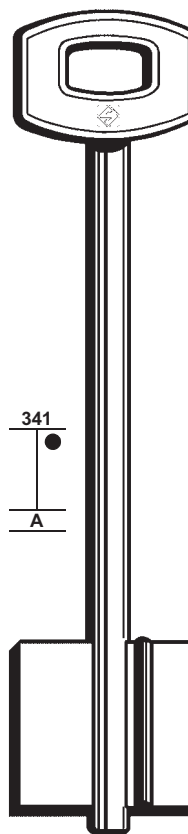
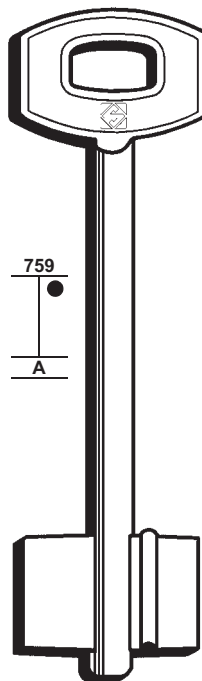
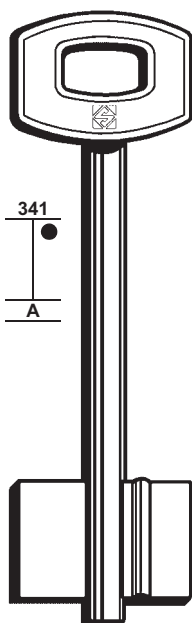
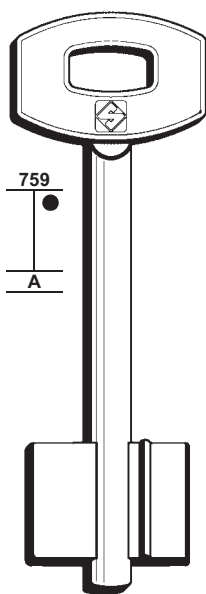
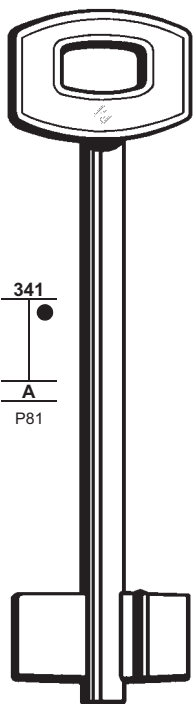

SB

5SCM6

SM

5SCM4

EM

EMME - SAB - SIBI

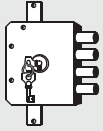

54

FOR/PER

SECUREMME (I)
SIBI

SELLA & VALZ (I)
+ (69)

FOR:
PER:

SECUREMME

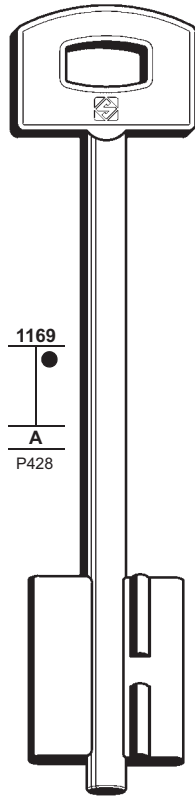

1169
A
P428



5SCM12

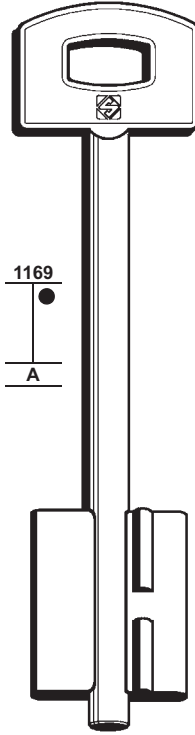

1169
A



5SCM14

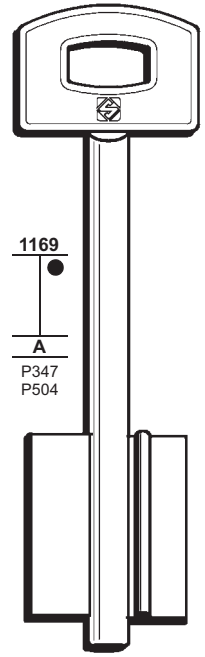

1169
A
P347
P504



5SCM8

FOR:
PER:

SECUREMME

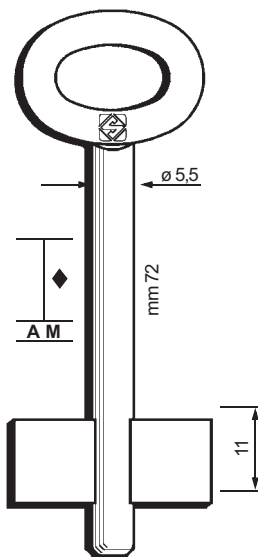

ø 5.5
mm 72
A M

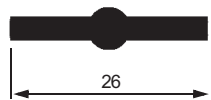

7659

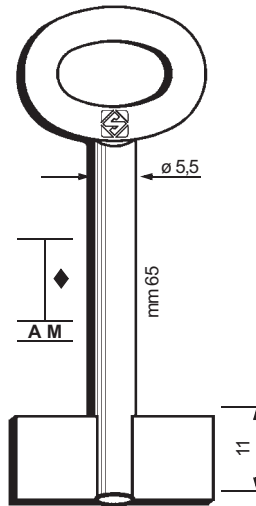

ø 5.5
mm 65
A M

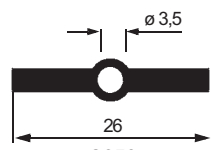

8659

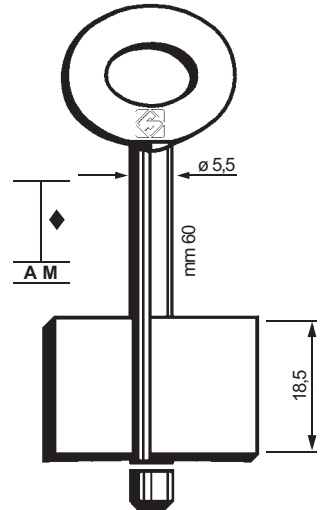

ø 5.5
mm 60
A M

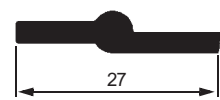

7656



8656

SIBI

FOR:
PER:

SELLA & VALZ

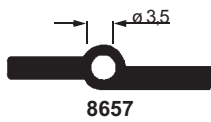
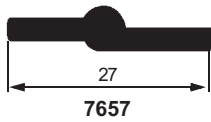
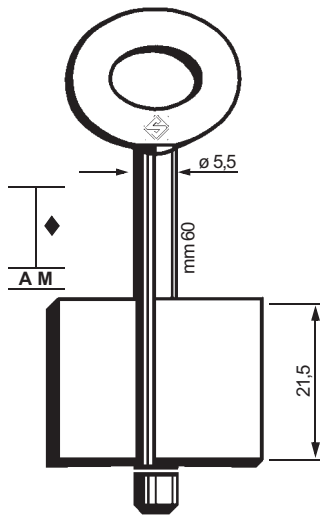

SERCAP

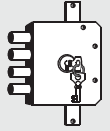
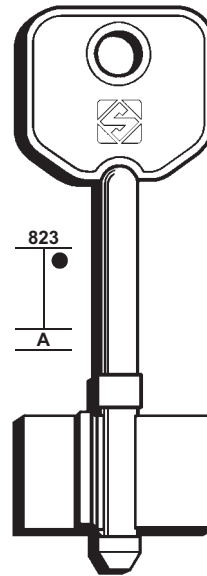
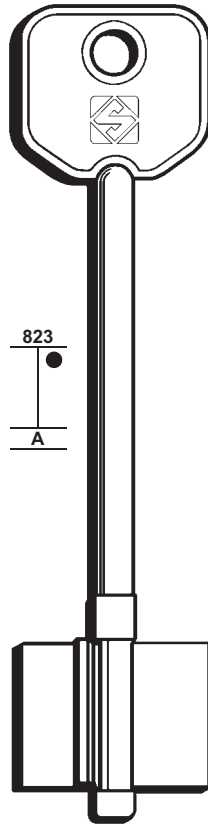

55

FOR/PER

SELLA & VALZ (I)
+ (68)

SERCAP (I)

SERMEC (I)
+ KASSEL (38)

FOR:
PER:

SERMEC

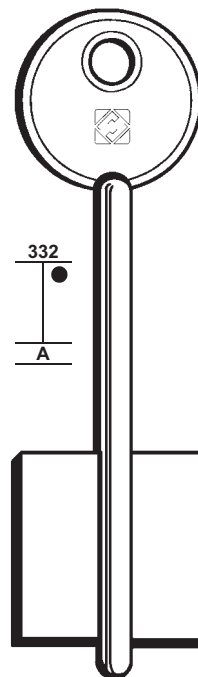
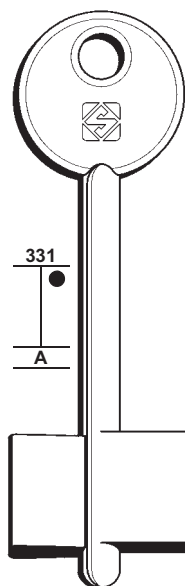
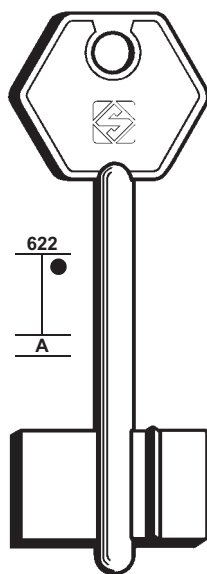
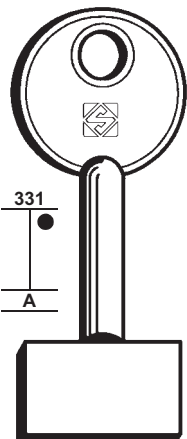

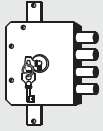

56

FOR/PER

SERMEC (I)
KASSEL
YALE
+ KASSEL (38)

SETEC (I)
 SAFE (52)

SIAS (I)

SIBI (I)
 SECUREMME (53-54)
+ (70)

SIDERAL (I)
CONFORTI

FOR:
PER:

SERMEC

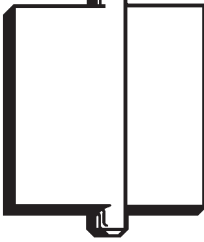
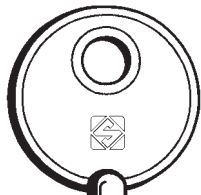

KL

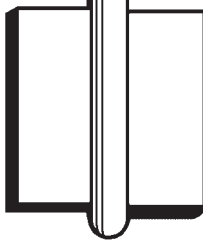
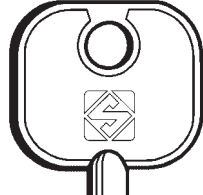

5SR2

KASSEL - YALE

SIAS

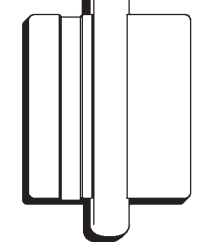
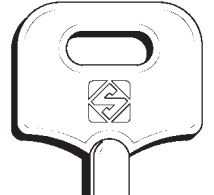

5SAS5

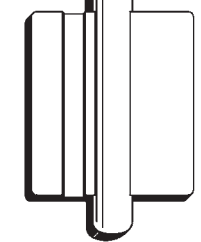
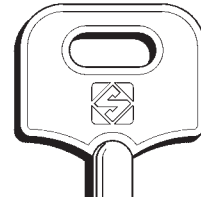

5SAS3

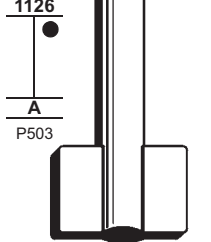

5SAS1

FOR:
PER:

SIDERAL

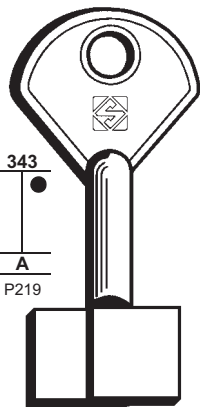

SDP

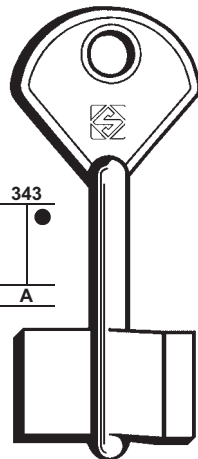

SDC

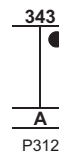
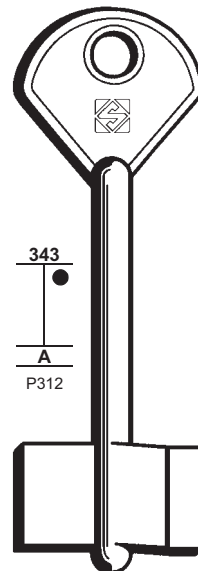

SDL

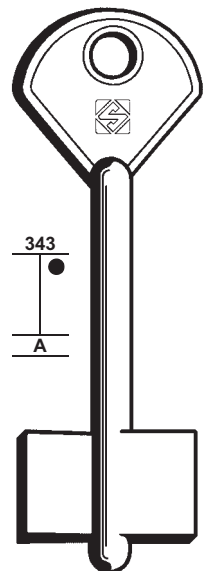

SD

CONFORTI

FOR:
PER:

SIS

SOLID

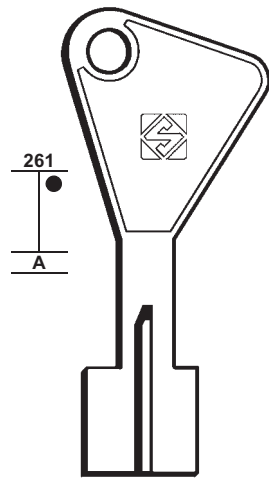

SSP3

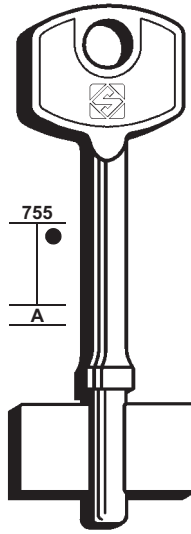

5SOL2

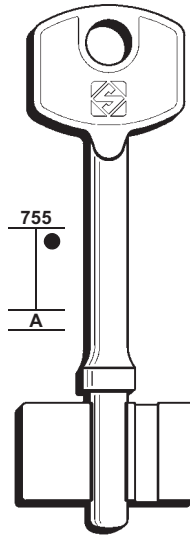

5SOL3

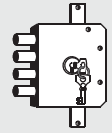

57

FOR/PER

SIS (P)

SOLID (ZA)

+  (67)

STAVER (LV)

CISA

STIEHM (D)

 (65-69-74-75)

STUV (D)

+  (70)

SWEDEN (S)

+  (66)

FOR:
PER:

STAVER

SWEDEN

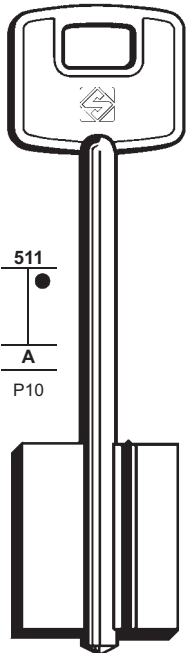

5CS2

CISA

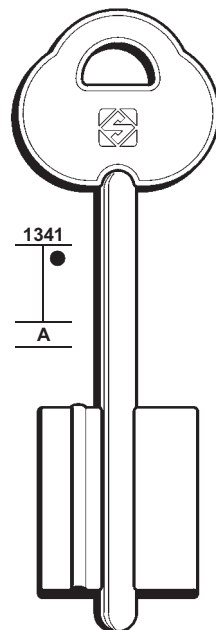

5STV1

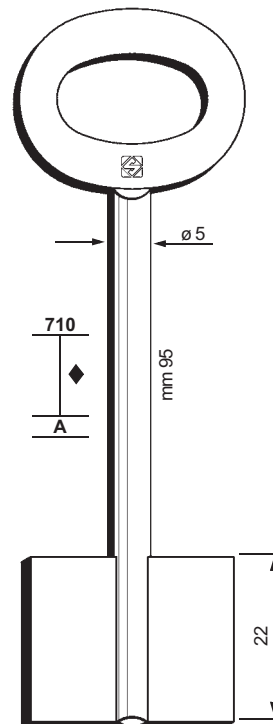

$\varnothing 3,1$

27

8695SSL

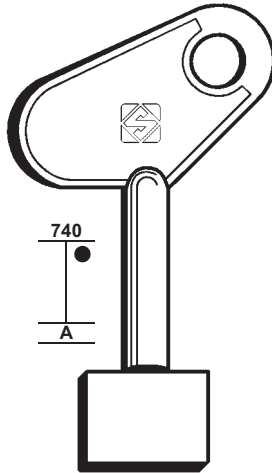
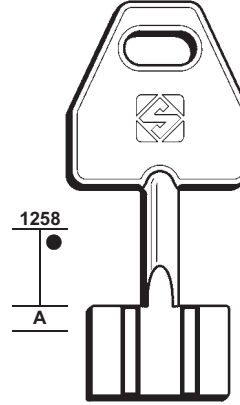
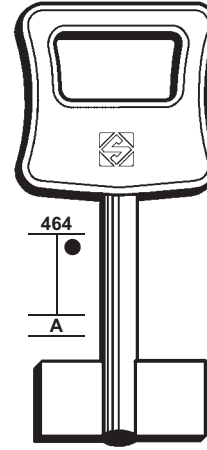
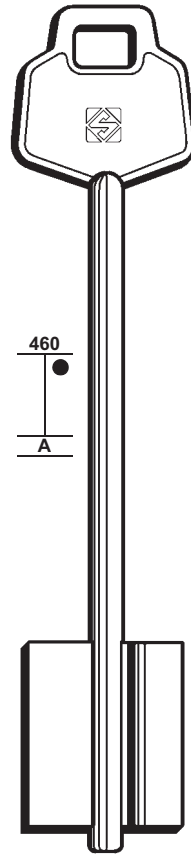
FOR: PER:	TOVER	TUSHINO	4 TR
	 <p>740 A</p> <p>5TV1</p>	 <p>1258 A</p> <p>5TU1</p>	 <p>464 A</p> <p>TRP</p>  <p>460 A</p> <p>TRL</p>

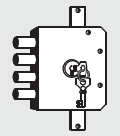

59

FOR/PER
TOVER (P)
TROLESE (I) SECUREMME (53) TO (58)
TUSHINO (RUS)
4 TR (I)
VAK (F) MUEL (46)
VILDETA (LT)
VIPER (I) POTENT (50)
VIRO (I) FEB CERUTTI (11-12-13) IDM (34-35) POTENT (49)

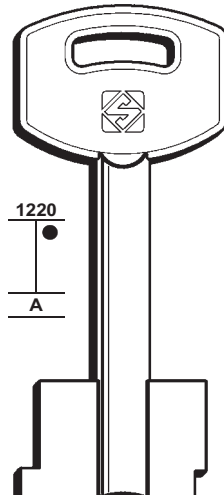
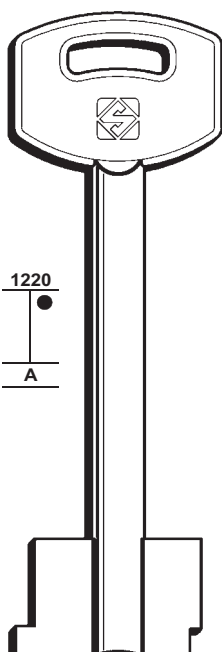
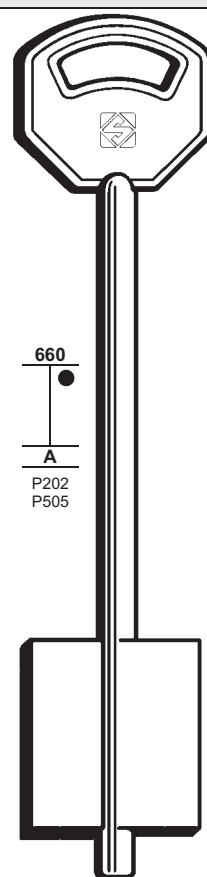
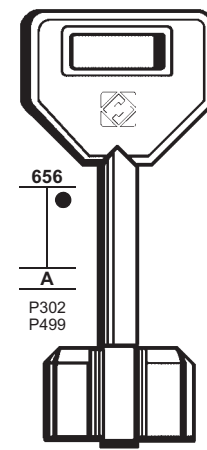
FOR: PER:	VILDETA	VIRO
	 <p>1220 A</p> <p>5VT1</p>  <p>1220 A</p> <p>5VT2</p>	 <p>660 A P202 P505</p> <p>5FEB3</p>  <p>656 A P302 P499</p> <p>5FEB5</p>

FEB

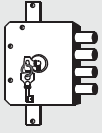

60

FOR/PER

WELKA (I)

WERTHEIM (D)

+ (79)

YALE (I)

KASSEL

+ FEB (28)

+ KASSEL (38)

FOR:
PER: WELKA

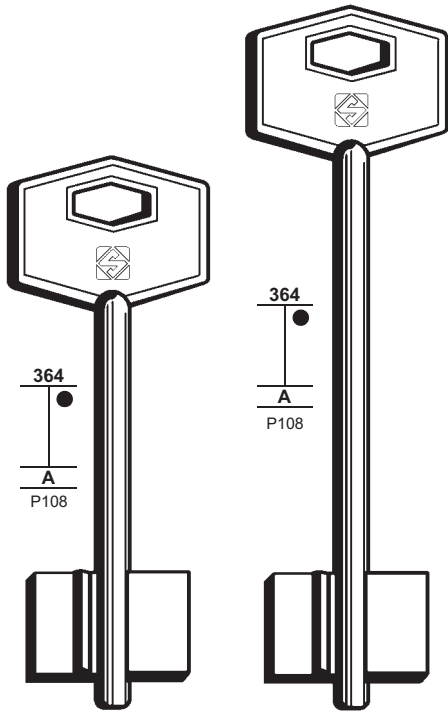

WM



W

YALE

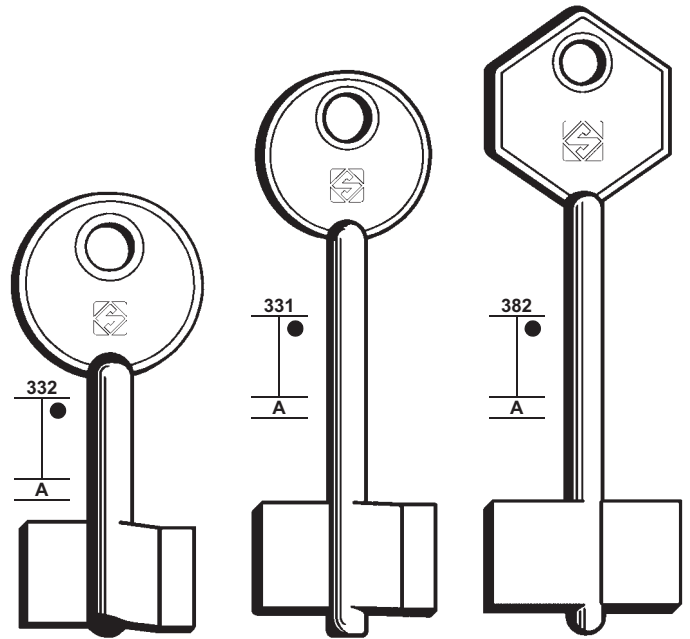

KYP



KC



YC

KASSEL

FOR:
PER:

YALE

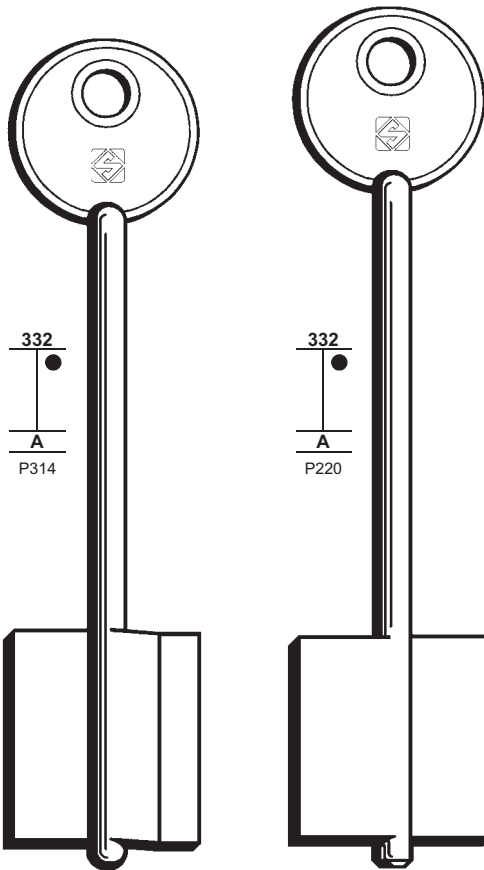

KYL



KL

KASSEL

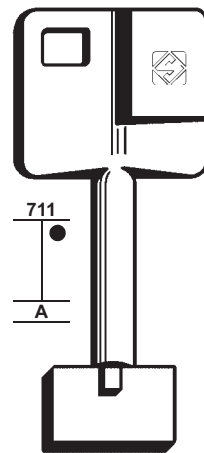

5YA1

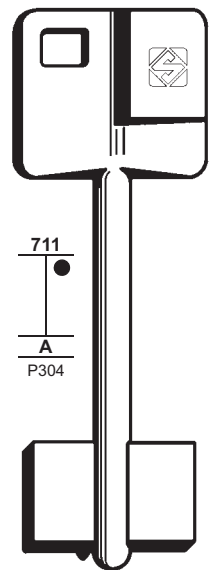

5YA4

FOR:
PER:

YALE

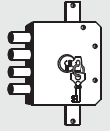

61

FOR/PER

YALE (1)

+ FEB (28)

+ KASSEL (38)

ZIME (1)

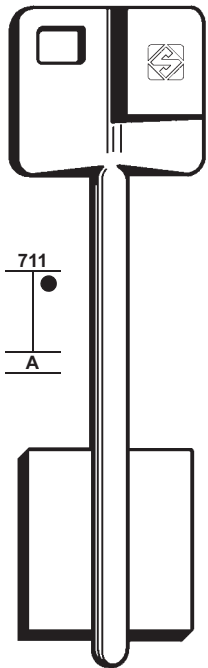

5YA6

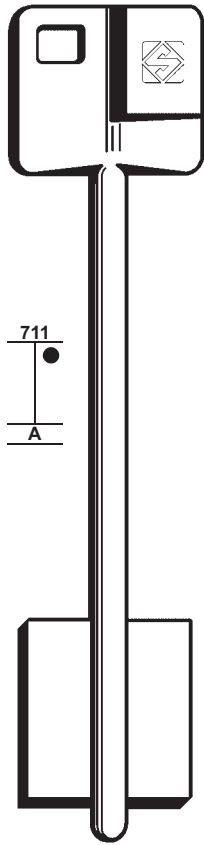

5YA8

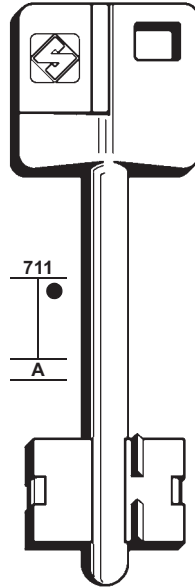

5YA20

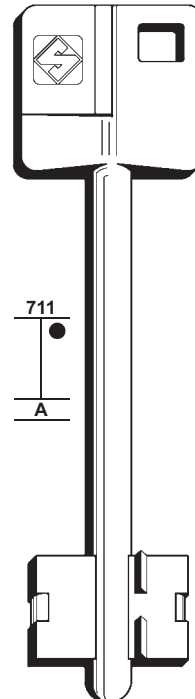

5YA22

FOR:
PER:

YALE

ZIME

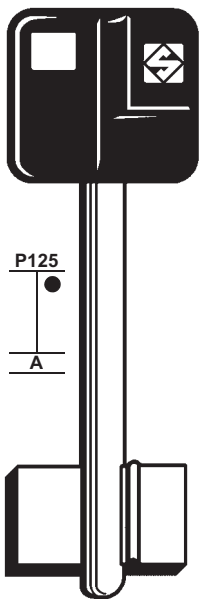

5YA10P

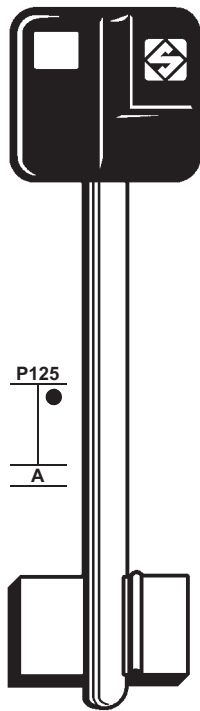

5YA14P

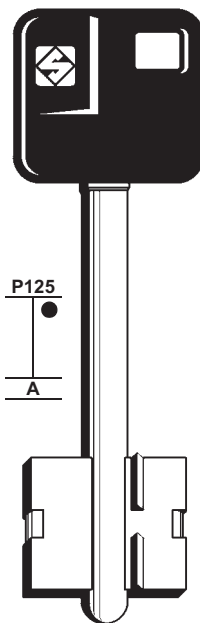

5YA18P

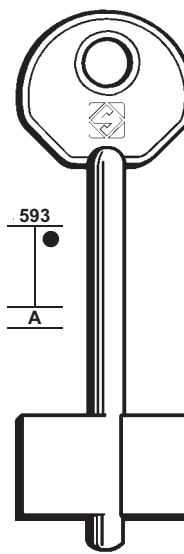

5ZM2



5YA9P



5YA13P



GB IMPORTANT

All information and illustrations in this catalogue are for guidance only.

Silca reserves the right to alter products designs, dimensions or info to improve the products quality.

The contents of this catalogue are fully protected by Copyright and may not be copied or reproduced in any form, without written permission from Silca.

Any infringements will be dealt with under Italian law.

F IMPORTANT

Les illustrations et les caractéristiques techniques des produits présentés dans ce catalogue sont données à titre indicatif.

Bien que les caractéristiques essentielles des produits soient invariables, Silca se réserve le droit d'apporter toutes les modifications qu'elle retiendra nécessaires et opportunes afin d'améliorer la qualité de ses produits.

Tous les dessins et photos sont propriété Silca et toute reproduction, même partielle, sans l'autorisation écrite préalable de Silca est interdite conformément aux prescriptions légales. Tout litige est du ressort exclusif des Tribunaux de la circonscription où se trouve le Siège de la Société.

I IMPORTANT

Le illustrazioni e i dati tecnici dei prodotti contenuti nel catalogo debbono considerarsi indicativi.

Silca si riserva il diritto, ferme restando le caratteristiche essenziali dei prodotti, di apportare tutte le modifiche che ritiene necessarie e opportune al fine di migliorare la qualità dei prodotti.

Tutti i disegni e le fotografie sono di proprietà di Silca, ogni riproduzione anche parziale, senza autorizzazione scritta della Silca è vietata secondo termini di legge.

Per qualsiasi controversia competenti sono gli Uffici Giudiziari dove ha sede l'Azienda, con espressa esclusione di qualsiasi altro foro.

E IMPORTANTE

Las ilustraciones y los datos técnicos de los productos en este catálogo son indicativos.

La Silca se reserva el derecho, quedando invariadas las características principales de los productos, de modificar todo lo que considere necesario y oportuno para mejorar la calidad de sus artículos.

Todos los dibujos y las fotografías pertenecen a la Silca; según determina la Ley, se prohíbe toda reproducción aunque parcial, sin autorización por escrito de la Silca.

En caso de disputas la competencia es de las autoridades judiciales donde está domiciliada la firma, excluyendo cualquier otro foro.

D WICHTIG

Die Abbildungen und technischen Daten des Katalogs sind nur zur Information.

Silca behält sich vor, etwaige Änderungen am Produkt, die zur Verbesserung desselben beitragen vorzunehmen.

Alle Zeichnungen und Fotos sind Besitz der Firma Silca, jede Reproduktion, auch teilweise, ist ohne schriftliche Erlaubnis der Firma Silca gesetzlich untersagt.

Im Falle von Streitfragen ist der Gerichtshof des Firmensitzes zuständig; jeder andere Gerichtshof ist ausgeschlossen.

P IMPORTANTE

As ilustrações e as características técnicas dos produtos apresentados neste catálogo são facultados a título indicativo.

Mesmo que as características essenciais dos produtos sejam invariáveis, à Silca reserva-se o direito de modificar ser necessário e oportuno los productos, afim de melhorar a sua qualidade.

Todos os desenhos e fotos são propriedade da Silca, e é proibida a sua reprodução mesmo parcial sem a autorização escrita da Silca conforme as prescrições legais.

Em caso de litígio fica desde já designado, excluindo qualquer outro, o Tribunal da comarca onde está registada a sede da Silca.

**GB IMPORTANT**

In compliance with current regulations relating to industrial property, we hereby state that the trade-marks or trade names mentioned in our catalogue are the exclusive property of authorized manufacturers of locks and users.

Said trade-marks or trade names are nominated only for the purposes of information so that any lock for which our keys are made can be rapidly identified.

This catalogue is reserved exclusively for professional key cutters who use Silca products.

I IMPORTANT

In conformità alle disposizioni legali in vigore relative alle proprietà industriali, informiamo che i marchi o le denominazioni commerciali citate nel nostro catalogo sono di proprietà esclusiva dei fabbricanti di serrature e degli utilizzatori autorizzati.

Questi marchi o denominazioni commerciali sono indicati a titolo di semplice informazione, con lo scopo di riconoscere velocemente a quali serrature le nostre chiavi sono destinate.

Questo catalogo è esclusivamente riservato ai professionisti della riproduzione chiavi che utilizzano i prodotti Silca.

D WICHTIG

Gemäß den derzeit geltenden Normen bezüglich des Industrieigentums teilen wir Ihnen mit, daß die im vorliegenden Katalog angeführten Markennamen oder Handelsmarken ausschließliches Eigentum der Schloßhersteller und zugelassenen Fachhändler sind.

Diese Markenbezeichnungen oder Handelsmarken sind nur zur Information angeführt, mit dem Zweck, schnell erkennen zu können, zu welchem Schloß unsere Schlüssel gehören.

Der vorliegende Katalog ist ausschließlich an Schlüsselkopier-Fachgeschäfte, die Silca Produkte benutzen, gerichtet.

F IMPORTANT

Conformément aux lois en vigueur concernant la propriété industrielle, nous vous informons que les marques et appellations commerciales citées dans notre catalogue appartiennent exclusivement aux fabricants de serrures et aux utilisateurs autorisés.

Ces marques ou appellations commerciales sont indiquées à titre d'information pure et simple pour vous permettre de déterminer rapidement les serrures auxquelles nos clés sont destinées.

Ce catalogue est réservé exclusivement aux professionnels du taillage de clés qui utilisent les produits Silca.

E IMPORTANTE

En conformidad con las vigentes disposiciones de ley sobre propiedad industrial, las marcas y denominaciones comerciales citadas en nuestro catálogo se declaran de propiedad exclusiva de los fabricantes de cerraduras y los utilizadores autorizados.

Dichas marcas o denominaciones comerciales se citan por simple información, al objeto de hacer comprender sin dificultad a qué cerraduras van destinadas nuestras llaves.

Este catálogo está reservado exclusivamente a los profesionales de la reproducción de llaves que utilizan los productos Silca.

P IMPORTANTE

Em conformidade com as disposições legais em vigor relativas à propriedade industrial, informamos que as marcas ou as denominações comerciais citadas no nosso catálogo são propriedade exclusiva dos fabricantes de fechaduras e dos utilizadores autorizados.

Estas marcas ou denominações comerciais são indicadas só a nível de informação, a fim de reconhecer rapidamente a quais fechaduras se destinam as nossas chaves.

Este catálogo é reservado exclusivamente aos profissionais da reprodução de chaves que utilizam os produtos Silca.